



SOFT TECH
SURGICAL

08

Dissecting
&
Ligature Forceps



SOFT TECH Surgical, Manufacturer & Exporter of Quality Instruments



LIGATURE FORCEPS STRAIGHT
08-0100
95 mm



MICRO-ADSON DISSECTING
FORCEPS CURVED
08-0105
140 mm



BABY-OVERHOLT DISSECTING
FORCEPS CURVED
08-0110
135 mm



BABY-MIXTER DISSECTING
FORCEPS CURVED

08-0115 140 mm
08-0120 180 mm



BABY-ADSON DISSECTING
FORCEPS CURVED



DISSECTING LIGATURE FORCEPS

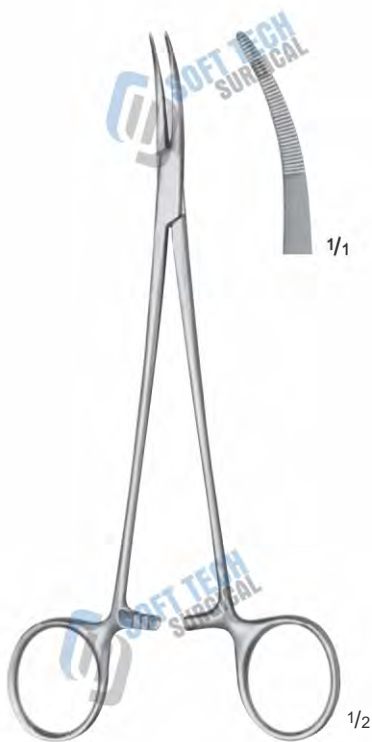

NISSEN ARTERY FORCEPS
CURVED
08-0135
185 mm

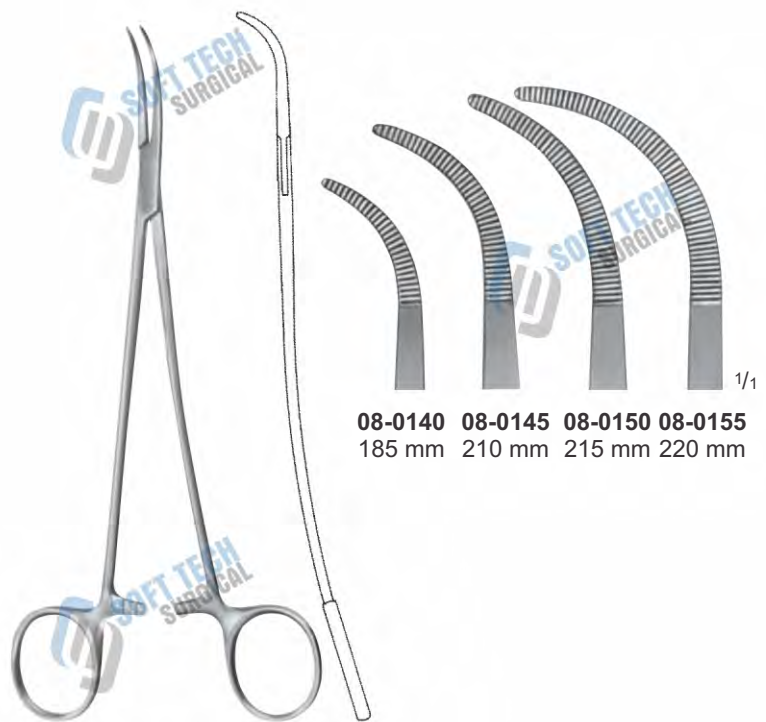

DISSECTING FORCEPS
S-SHAPED, DELICATE

SOFT TECH Surgical, Manufacturer & Exporter of Quality Instruments

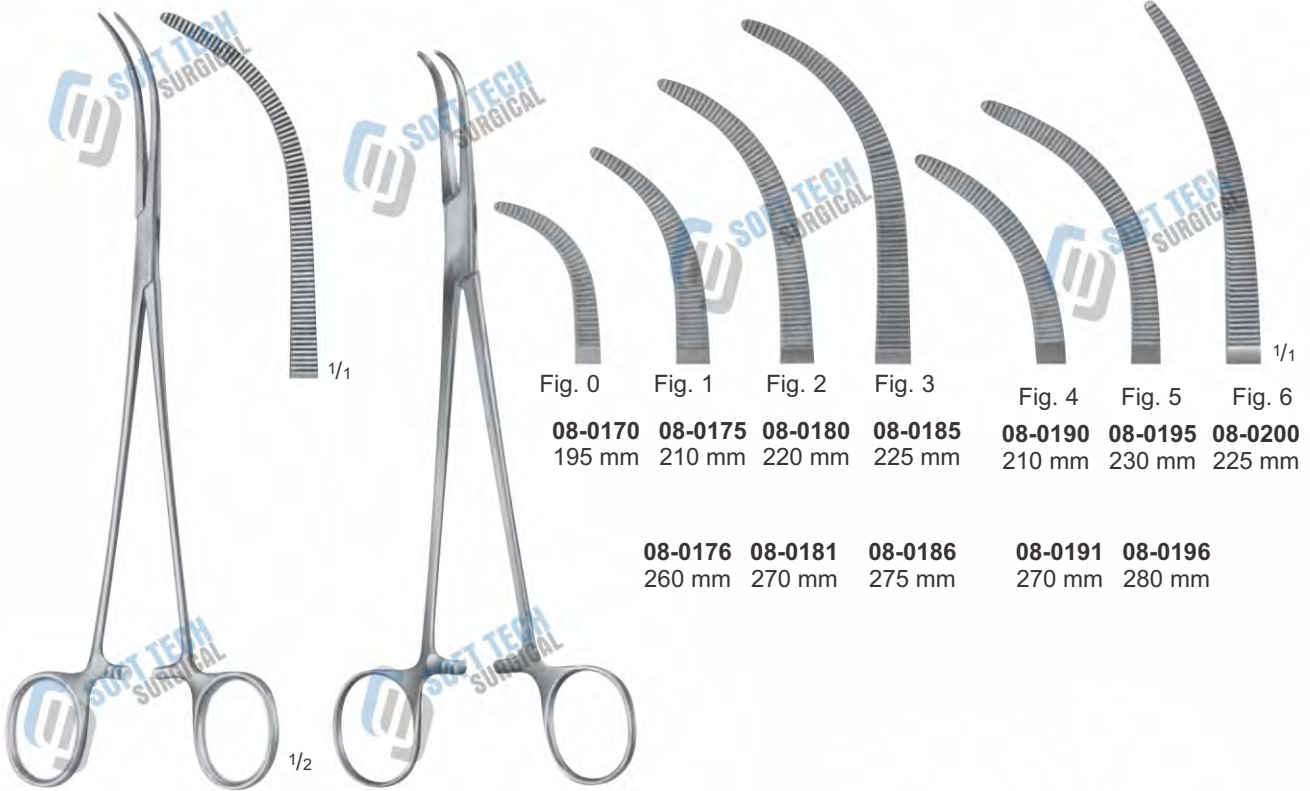

Fig. 0	Fig. 1	Fig. 2	Fig. 3	Fig. 4	Fig. 5	Fig. 6
08-0170	08-0175	08-0180	08-0185	08-0190	08-0195	08-0200
195 mm	210 mm	220 mm	225 mm	210 mm	230 mm	225 mm
	08-0176	08-0181	08-0186	08-0191	08-0196	
	260 mm	270 mm	275 mm	270 mm	280 mm	

**OVERHOLT MIXTER
DISSECTING FORCEPS
CURVED
08-0160
205 mm**

**OVERHOLT- GEISSENDÖRFER
DISSECTING FORCEPS**

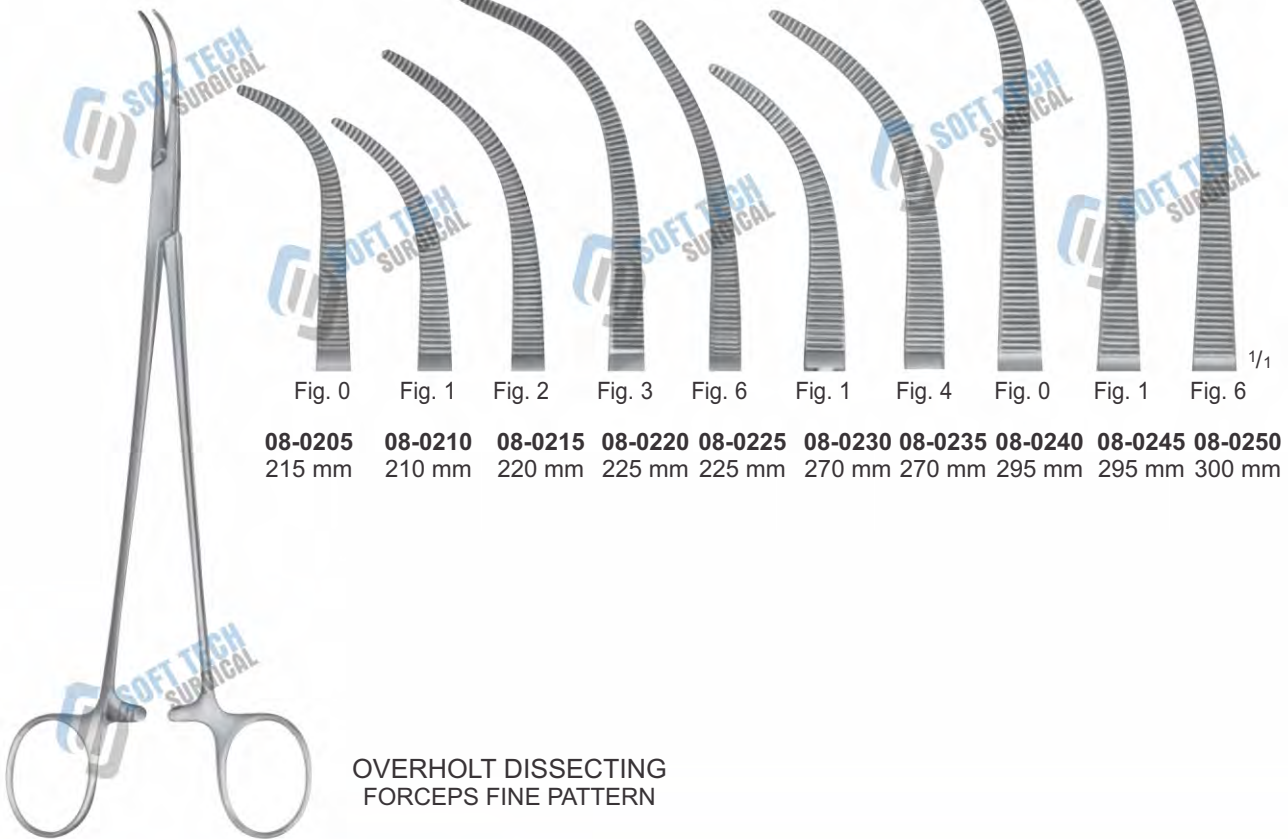

Fig. 0	Fig. 1	Fig. 2	Fig. 3	Fig. 6	Fig. 1	Fig. 4	Fig. 0	Fig. 1	Fig. 6
08-0205	08-0210	08-0215	08-0220	08-0225	08-0230	08-0235	08-0240	08-0245	08-0250
215 mm	210 mm	220 mm	225 mm	225 mm	270 mm	270 mm	295 mm	295 mm	300 mm

**OVERHOLT DISSECTING
FORCEPS FINE PATTERN**



08-0255 130 mm
08-0260 180 mm
08-0265 200 mm
08-0270 230 mm
08-0275 280 mm

GEMINI DISSECTING FORCEPS



MIXTER- O'SHAUGHNESSY
DISSECTING FORCEPS CURVED
08-0280
190 mm



O'SHAUGHNESSY DISSECTING
FORCEPS CURVED
08-0285
220 mm

SOFT TECH Surgical, Manufacturer & Exporter of Quality Instruments



**HEISS ARTERY FORCEPS
CURVED**
08-0290
195 mm



**WIKSTRÖM DISSECTING
FORCEPS CURVED**
08-0295
205 mm



**RUMEL DISSECTING FORCEPS
CURVED**
240 mm

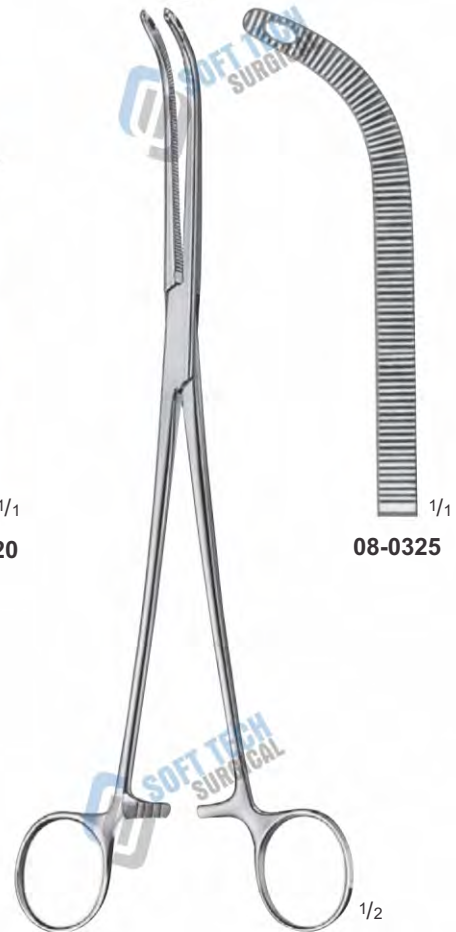
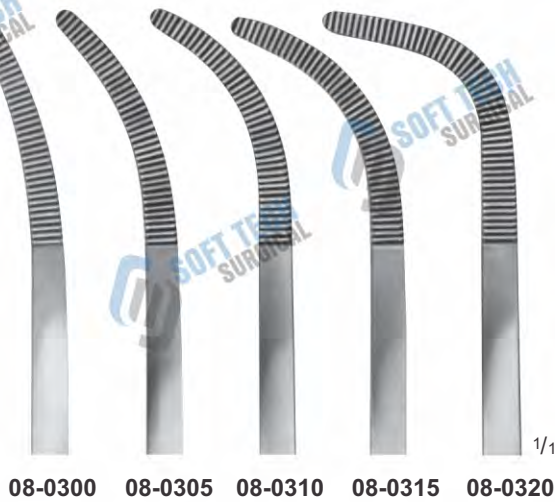

**FINOCHIETTO DISSECTING FORCEPS
CURVED**
245 mm



08-0330
200 mm

08-0331
240 mm

08-0332
275 mm



08-00335
extra delicate

08-0340
delicate

**KANTROWITZ DISSECTING
FORCEPS CURVED**

BARRÉ DISSECTING CLAMP
280 mm

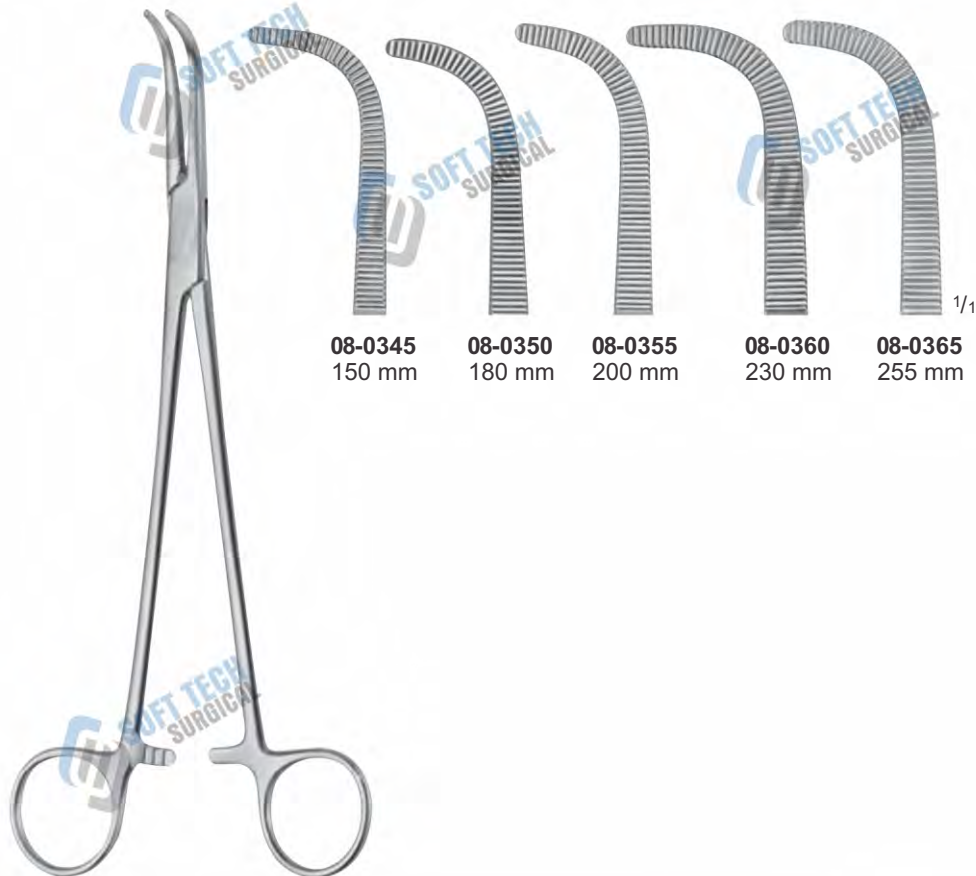

08-0345
150 mm

08-0350
180 mm

08-0355
200 mm

08-0360
230 mm

08-0365
255 mm

**O'SHAUGHNESSY DISSECTING
FORCEPS**



MIXTER DISSECTING GALL DUCT
CYSTIC FORCEPS CURVE
08-0370
230 mm



LAWRENCE DISSECTING FORCEPS
CURVED
08-0375
270 mm



08-0380
300 mm

08-0385
290 mm

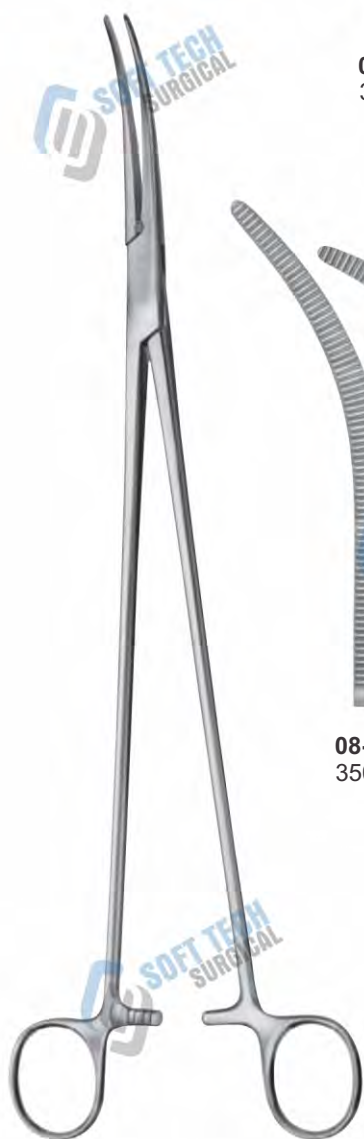

ZENKER DISSECTING FORCEPS
CURVED

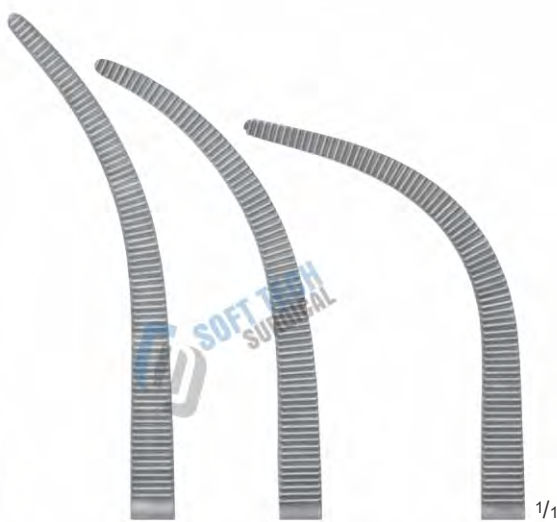

08-0390
350 mm

08-0395
350 mm

08-0400
350 mm



KIEBACK URETERAL TUNNEL CLAMP
CURVED

08-0405
235 mm

08-0410
350 mm

SOFT TECH Surgical, Manufacturer & Exporter of Quality Instruments



LOWER GALL DUCT FORCEPS
08-0415
180 mm



LAHEY GALL DUCT FORCEPS

(SWEET)	DISSECTING	DISSECTING
08-0420	08-0425	08-0430
200 mm	225 mm	230 mm



MIXTER DISSECTING FORCEPS CURVED

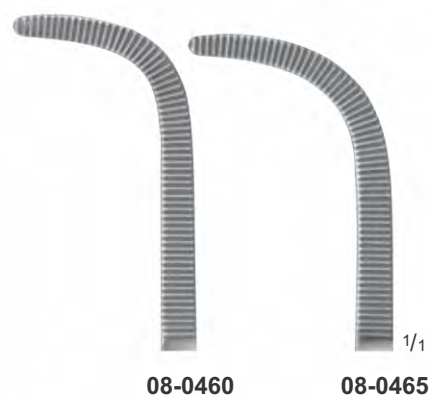

DESJARDINS GALL DUCT
FORCEPS
08-0450
210 mm

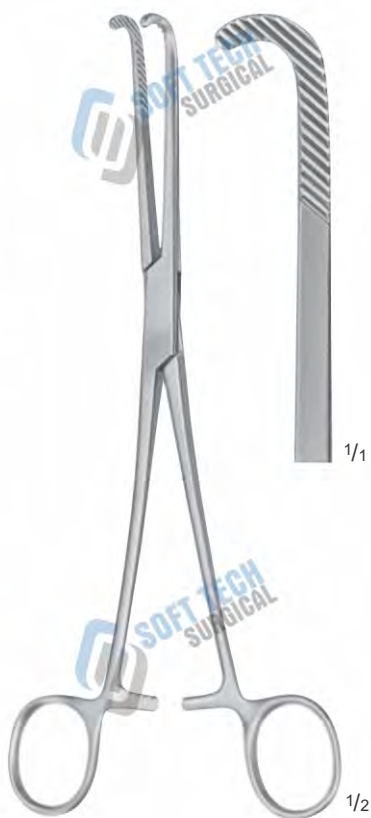

NISSEN GALL DUCT FORCEPS
08-0455
215 mm



GRAY GALL DUCT FORCEPS
220 mm

SOFT TECH Surgical, Manufacturer & Exporter of Quality Instruments



MIKULICZ PERITONEUM FORCEPS
CURVED
08-0470
140 mm



MIKULICZ PERITONEUM FORCEPS
CURVED
08-0475
185 mm



MIKULICZ PERITONEUM FORCEPS
CURVED

08-0480 180 mm
08-0485 205 mm



MIKULICZ PERITONEUM FORCEPS
CURVED
08-0490
205 mm

SOFT TECH Surgical, Manufacturer & Exporter of Quality Instruments



MIKULICZ PERITONEUM
FORCEPS CURVED
08-0495
205 mm



MIKULICZ PERITONEUM
FORCEPS CURVED
08-0500
200 mm



MIKULICZ PERITONEUM
FORCEPS CURVED
08-0505
245 mm



MIKULICZ PERITONEUM
FORCEPS CURVE
08-0510
205 mm



MIKULICZ PERITONEUM
FORCEPS CURVE
08-0515
205 mm



MIKULICZ PERITONEUM
FORCEPS CURVE
08-0520
185 mm

SOFT TECH Surgical, Manufacturer & Exporter of Quality Instruments



08-0525
1X2 TEETH



08-0530
1X2 TEETH



08-0535
210 mm
1X2 TEETH



08-0540
205 mm
1X2 TEETH

FAURE PERITONEUM
FORCEPS CURVED
205 mm

PHANEUF HYSTEREKTOMY
FORCEPS STRAIGHT

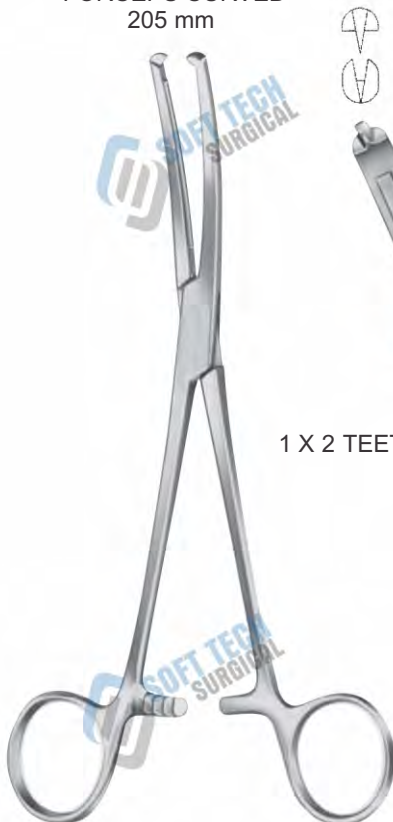

1 X 2 TEETH



08-0545
205 mm

08-0550
250 mm

MAINGOT HYSTERECTOMY
CLAMP CURVED

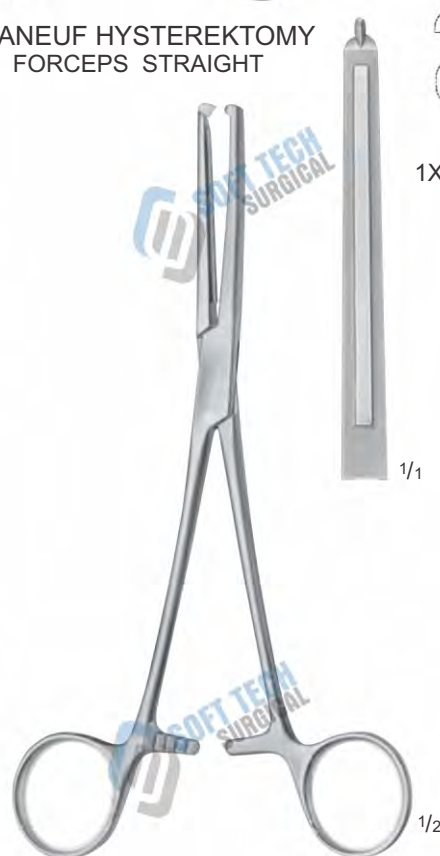

1X2 TEETH

MAINGOT HYSTERECTOMY
FORCEPS STRAIGHT
08-0555
200 mm



08-0560
205 mm



08-0565
245 mm



08-0570
350 mm

HEANEY MODIF. HYSTERECTOMY
FORCEPS CURVED



HEANEY HYSTERECTOMY
FORCEPS CURVED
08-0575
195 mm



HEANEY-REZEK
PERITONEUM AND
HYSTERECTOMY FORCEPS
08-0580
210 mm



SOFT TECH Surgical, Manufacturer & Exporter of Quality Instruments

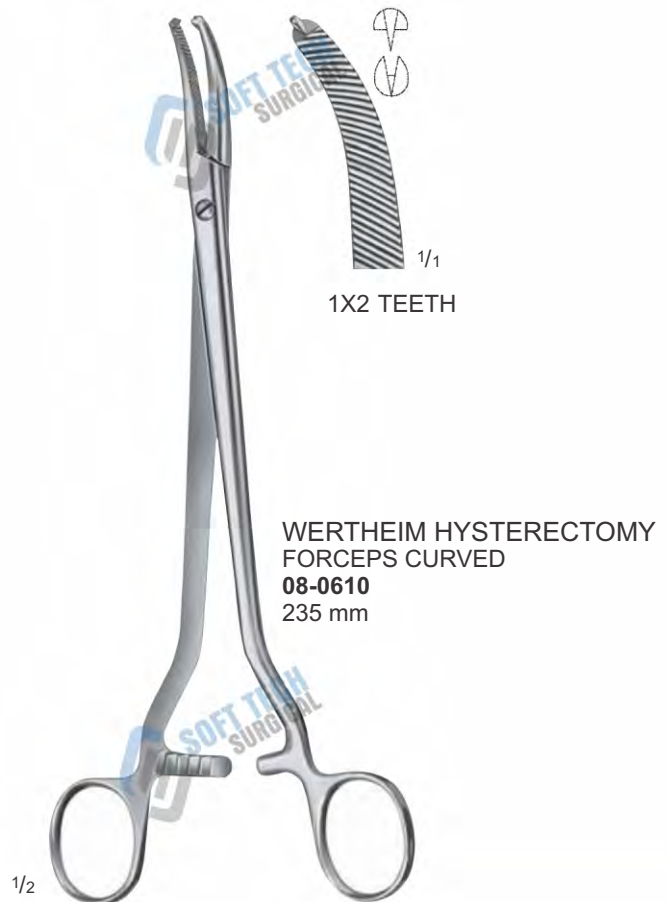
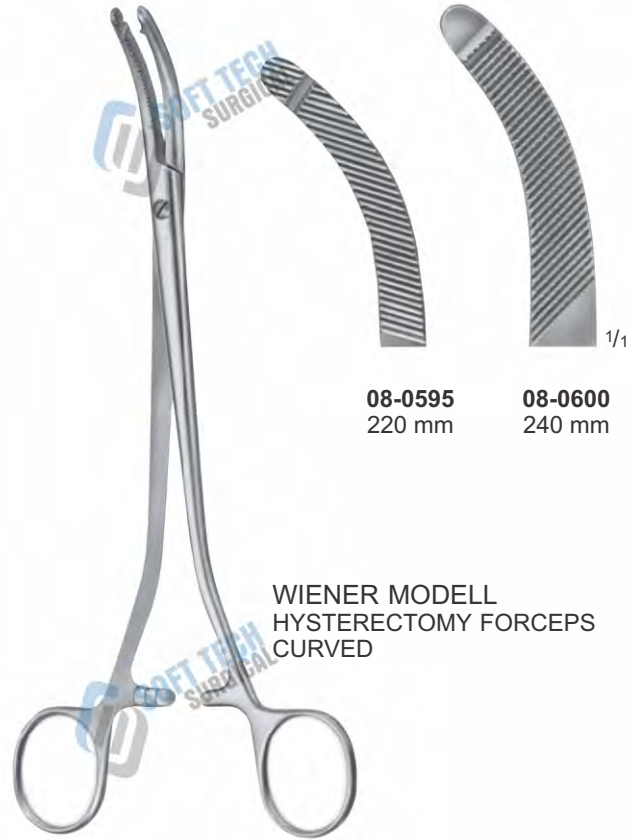



08-0615
245 mm
1x2 Teeth



08-0620
350 mm
1x2 Teeth



08-0625
240 mm
STR



08-0630
240 mm
CVD

WERTHEIM HYSTERECTOMY
FORCEPS CURVED

SECOND- LANDAU HYSTERECTOMY
FORCEPS

SOFT TECH Surgical, Manufacturer & Exporter of Quality Instruments



08-0635
245 mm
1x2 Teeth
STR



08-0640
245 mm
1x2 Teeth
CVD



08-0645
350 mm
1x2 Teeth
CVD

**HOLZBACH HYSTERECTOMY
FORCEPS**



08-0650
1x2Teeth
STR



08-0655
1x2Teeth
CVD

**GWILLIAM HYSTERECTOMY
FORCEPS**
200 mm

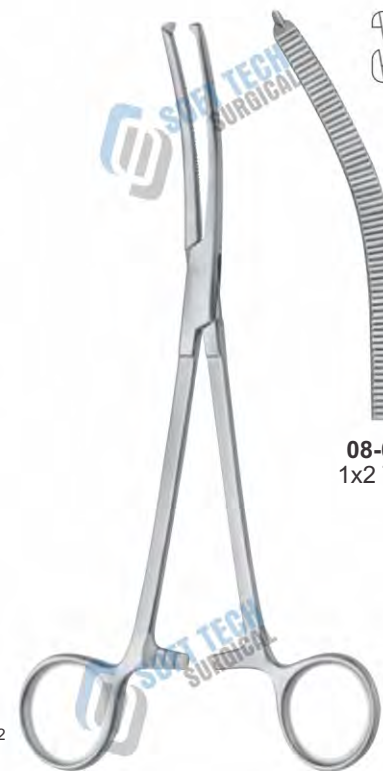

08-0660
1x2 Teeth

**BERKELEY-BONNEY
HYSTERECTOMY
FORCEPS CURVED**
200 mm



HEANEY HYSTERECTOMY
FORCEPS ATRAUMATIC



08-0665
225 mm
STR



08-0670
220 mm
CVD



08-0675
215 mm
CVD

1/1



WERTHEIM HYSTEREKTOMY
FORCEPS PARAMETRIUM



08-0680
250 mm
STR



08-0685
245 mm
CVD



08-0690
240 mm
CVD



08-0695
220 mm
CVD

1/1

SOFT TECH Surgical, Manufacturer & Exporter of Quality Instruments



08-0700
250 mm
STR



08-0701
350 mm
STR



08-0705
250 mm
CVD



08-0706
350 mm
CVD



**KIEBACK ATRAUMATA
HYSTERECTOMY CLAMP**



1/1



WERTHEIM HYSTERECTOMY
FORCEPS CURVED
08-0710
255 mm



1/1



WERTHEIM HYSTERECTOMY
FORCEPS CURVED
08-0715
260 mm

SOFT TECH Surgical, Manufacturer & Exporter of Quality Instruments



BURKE HYSTERECTOMY FORCEPS
PARAMETRIUM, SHORT JAWS



BURKE HYSTERECTOMY FORCEPS
PARAMETRIUM, SHORT JAWS

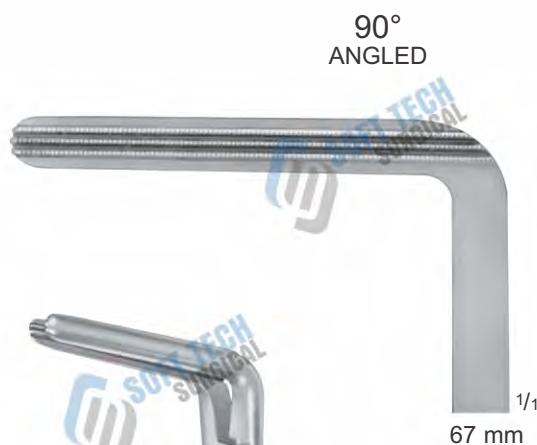

DICK ATRAUMATA VASCULAR CLAMP
PRESSURE CLAMP



WERTHEIM COMPRESSION
FORCEPS
08-0735
250 mm

SOFT TECH Surgical, Manufacturer & Exporter of Quality Instruments

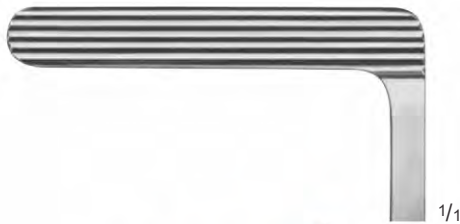

1/1



WERTHEIM- CULLEN COMPRESSION
FORCEPS CURVED
08-0740
215 mm



1/1

08-0746
80 mm

08-0745
60 mm



BRONCHUS FORCEPS SIGMOID
ANASTOMOSIS FORCEPS
230 mm



**SOFT TECH
SURGICAL**

General Surgery Instruments Catalogue

SOFT TECH Surgical

Muslim Town, Airport Road
Kotli Behram, Sialkot 51310
Pakistan.

Email : info@softtechsurgical.com
Website : www.softtechsurgical.com

Phone : +92 52 3573488
+92 52 3242929
+92 52 4264934
Fax : +92 52 3242929

 +92 336 4770459