



**SOFT TECH**  
**SURGICAL**

**05**

Dissecting  
&  
Tissue Forceps



SOFT TECH Surgical, Manufacturer & Exporter of Quality Instruments



MICRO FORCEPS  
JEWELER TYPE  
**05-0100**  
110 mm



MICRO FORCEPS  
JEWELER TYPE  
**05-0105**  
110 mm



MICRO FORCEPS  
JEWELER TYPE ANGLED  
**05-0110**  
110 mm



MICRO FORCEPS  
JEWELER TYPE, CURVED  
**05-0115**  
115 mm



MICRO FORCEPS  
JEWELER TYPE  
**05-0120**  
115 mm



MICRO FORCEPS  
JEWELER TYPE  
**05-0125**  
135 mm

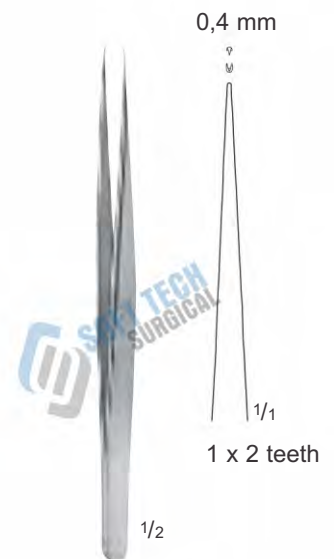

MICRO FORCEPS  
JEWELER TYPE  
**05-0130**  
135 mm

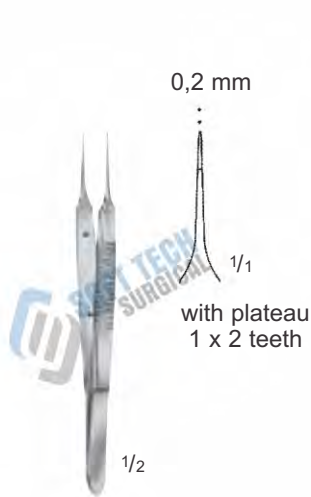

BONNER MODELL  
SUTURE TYING FORCEPS  
**05-0135**  
95 mm

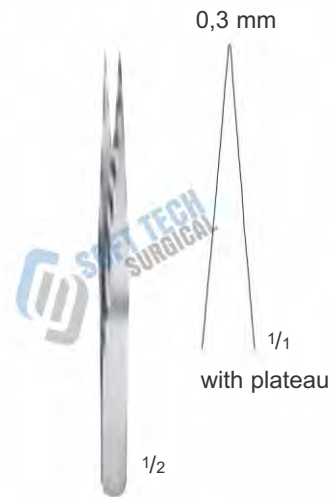

SUTURE TYING  
FORCEPS  
**05-0140**  
120 mm

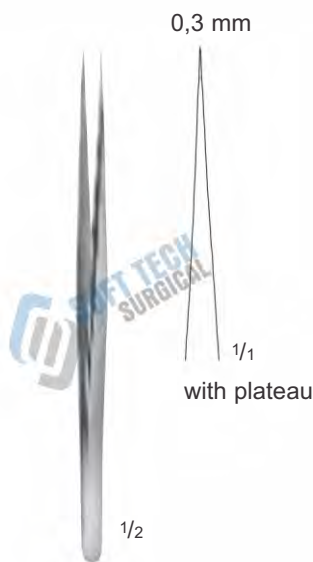

VISE SUTURE TYING  
FORCEPS STRAIGHT  
**05-0145**  
135 mm



VISE SUTURE TYING  
FORCEPS CURVED  
**05-0150**  
135 mm

SOFT TECH Surgical, Manufacturer & Exporter of Quality Instruments



LAZAR SUTURE  
TYING FORCEPS  
**05-0155**  
155 mm

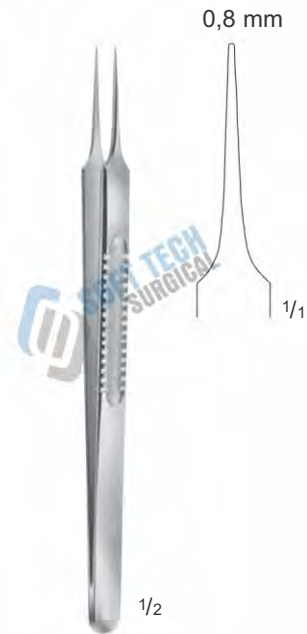

LAZAR SUTURE  
TYING FORCEPS  
**05-0160**  
155 mm



SUTURE TYING  
FORCEPS  
**05-0165**  
185 mm



AUSTIN SUTURE  
TYING FORCEPS  
**05-0170**  
140 mm

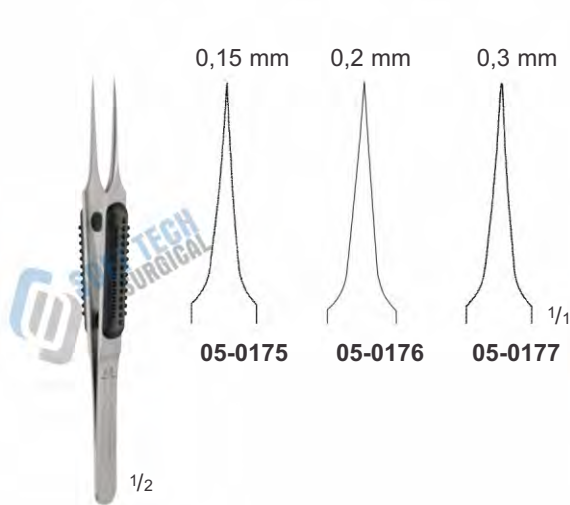

MÜLLER MICRO  
FORCEPS  
110 mm



MÜLLER MICRO  
FORCEPS  
05-0180  
110 mm



MÜLLER MICRO  
FORCEPS RING  
110 mm



MÜLLER MICRO FORCEPS  
160 mm



MÜLLER MICRO FORCEPS  
05-0195  
160 mm



MÜLLER MICRO FORCEPS  
05-0200  
160 mm



SOFT TECH Surgical, Manufacturer & Exporter of Quality Instruments

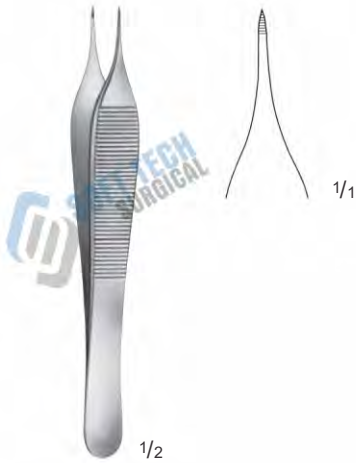

**THORPE CORNEAL FORCEPS**  
**05-0205**  
120 mm

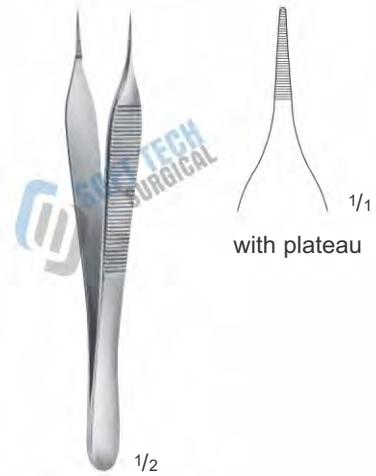

**MICRO-ADSON  
DISSECTING FORCEPS**  
**05-0210**  
120 mm

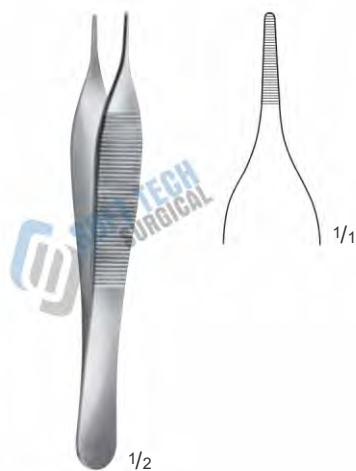

**ADSON DISSECTING FORCEPS**  
**05-0215**  
120 mm



**HUDSON DELICATE  
DISSECTING FORCEPS**  
**05-0220**  
125 mm



**MICRO-ADSON  
DISSECTING FORCEPS**  
**05-0225**  
150 mm



**ADSON DISSECTING FORCEPS**  
**05-0230**  
180 mm



**JEFFERSON DISSECTING FORCEPS**  
**05-0235**  
180 mm

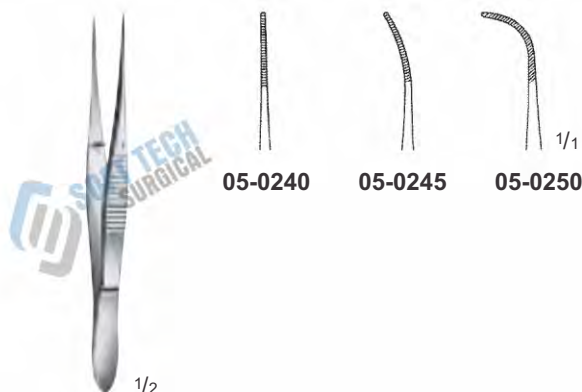

**IRIS DISSECTING  
FORCEPS**  
100 mm

SOFT TECH Surgical, Manufacturer & Exporter of Quality Instruments



SEMKEN DISSECTING  
FORCEPS DELICATE



DISSECTING FORCEPS  
**05-0265**  
155 mm



GILLIES DISSECTING FORCEPS  
**05-0270**  
150 mm



MC INDOE  
DISSECTING FORCEPS  
**05-0275**  
150 mm



GERALD DISSECTING  
FORCEPS



CAIRNS- DOTT  
DISSECTING FORCEPS





CUSHING DISSECTING  
FORCEPS

BROPHY DISSECTING  
FORCEPS  
200 mm

DISSECTING FORCEPS  
05-0330  
200 mm



DISSECTING FORCEPS  
SMOOTH JAWS



CUSHING DISSECTING  
FORCEPS  
05-0340  
200 mm



DISSECTING  
FORCEPS ANGLED  
05-0345  
200 mm

SOFT TECH Surgical, Manufacturer & Exporter of Quality Instruments

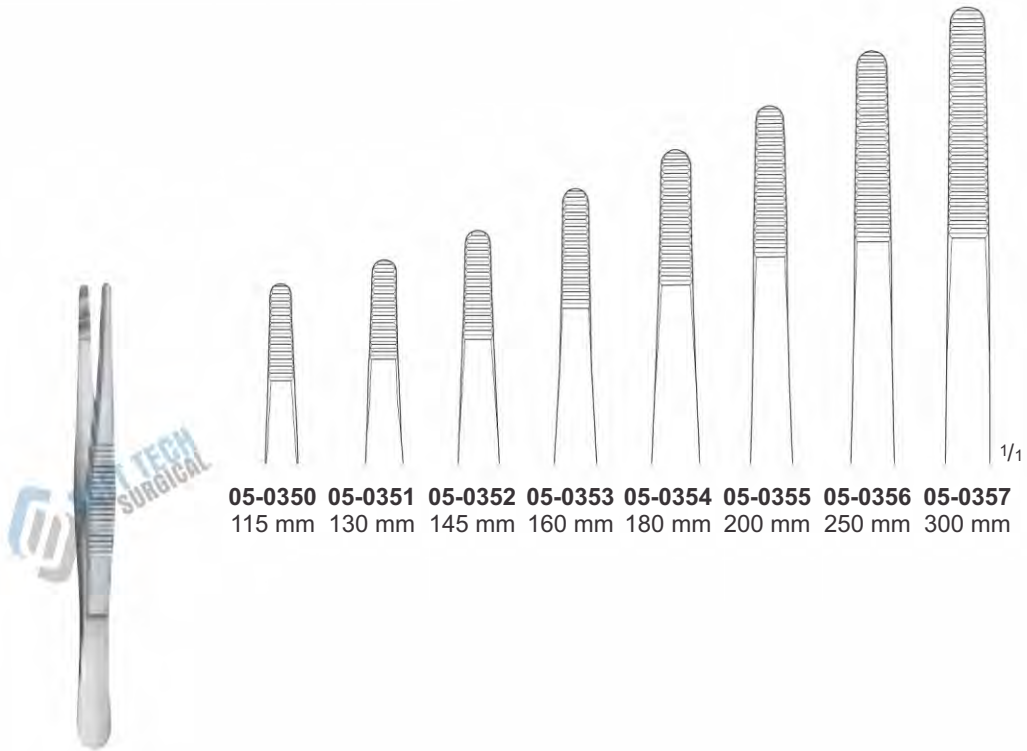

DISSECTING FORCEPS  
STANDARD

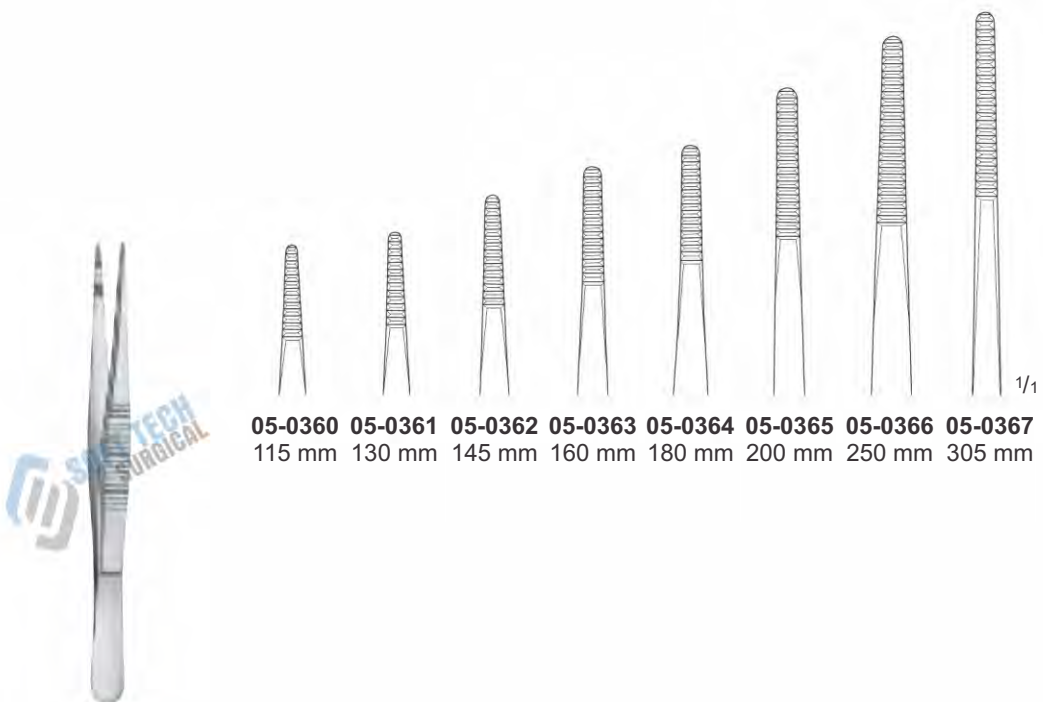

DISSECTING FORCEPS  
MEDIUM



**05-0370**  
130 mm

**05-0371**  
145 mm

**05-0380** 130 mm  
**05-0381** 150 mm  
**05-0382** 170 mm  
**05-0383** 200 mm

DISSECTING FORCEPS  
MEDIUM

DISSECTING  
FORCEPS BROAD  
PATTERN  
**05-0375**  
145 mm

DISSECTING FORCEPS  
SWEDISH PATTERN

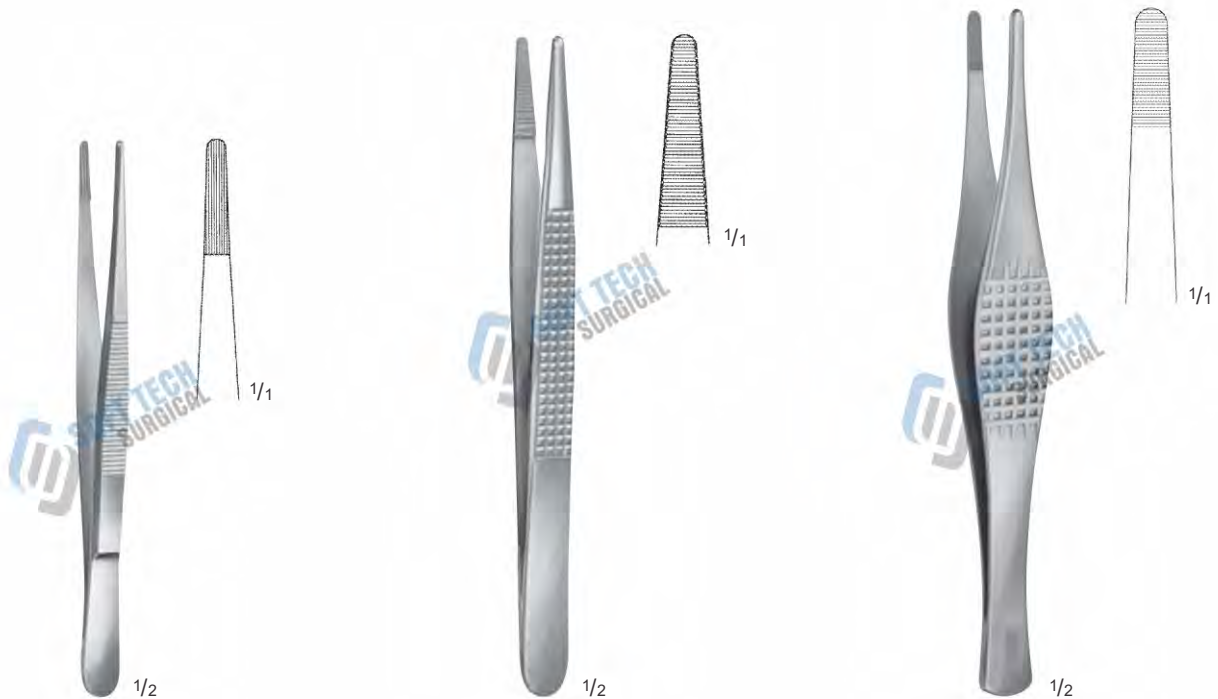

OCHSNER SUTURE  
FORCEPS  
**05-0385**  
145 mm

BONNEY DISSECTING  
FORCEPS  
**05-0390**  
175 mm

RAMSEY DISSECTING  
FORCEPS  
**05-0395**  
180 mm

SOFT TECH Surgical, Manufacturer & Exporter of Quality Instruments



DE BAKEY VASCULAR FORCEPS



DE BAKEY ATRAUMATA  
DISSECTING FORCEPS



DE BAKEY ATRAUMATA  
DISSECTING FORCEPS



DE BAKEY ATRAUMATA  
DISSECTING FORCEPS





DE BAKEY ATRAUMATA  
DISSECTING FORCEPS

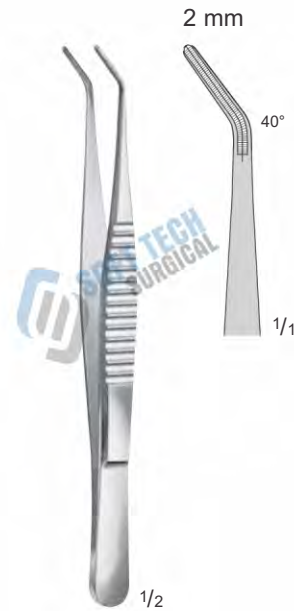

DE BAKEY ATRAUMATA  
DISSECTING FORCEPS  
**05-0450**  
150 mm



DE BAKEY ATRAUMATA  
DISSECTING FORCEP  
**05-0455**  
200 mm



COOLEY ATRAUMATA –  
ATRAUMATIC FORCEPS



SOFT TECH Surgical, Manufacturer & Exporter of Quality Instruments



**05-0465**  
120 mm

ADSON TC  
DISSECTING FORCEP



**05-0470 05-0471**  
145 mm 180 mm

DISSECTING  
FORCEPS



**05-0475 05-0476**  
200 mm 250 mm

DISSECTING  
FORCEPS



**05-0480**  
230 mm

DISSECTING  
FORCEPS



**05-0485**  
200 mm

SUTURE  
FORCEPS CUSHION SHAPED



**05-0490**  
175 mm

FERRIS- SMITH  
SUTURE FORCEPS



**05-0495 05-0496**  
150 mm 230 mm

WANGENSTEEN  
DISSECTING FORCEPS



DISSECTING  
FORCEPS

CUSHING  
DISSECTING FORCEPS  
WITH SCRAPER END

GRÜNWARD  
DISSECTING FORCEPS

SOFT TECH Surgical, Manufacturer & Exporter of Quality Instruments

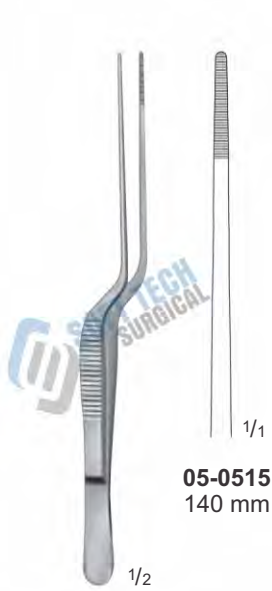

LUCAE DISSECTING  
FORCEPS BAYONET SHAPED

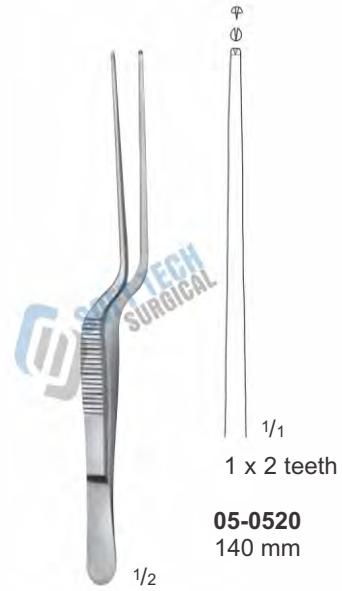

LUCAE TISSUE FORCEPS  
BAYONET SHAPED



COTTLE FIXATION FORCEPS  
TOOTHED AND SERRATED

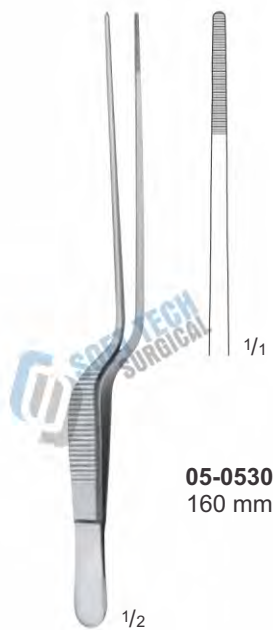

JANSEN DISSECTING  
FORCEPS BAYONET SHAPED



ADSON DISSECTING  
FORCEPS BAYONET SHAPE

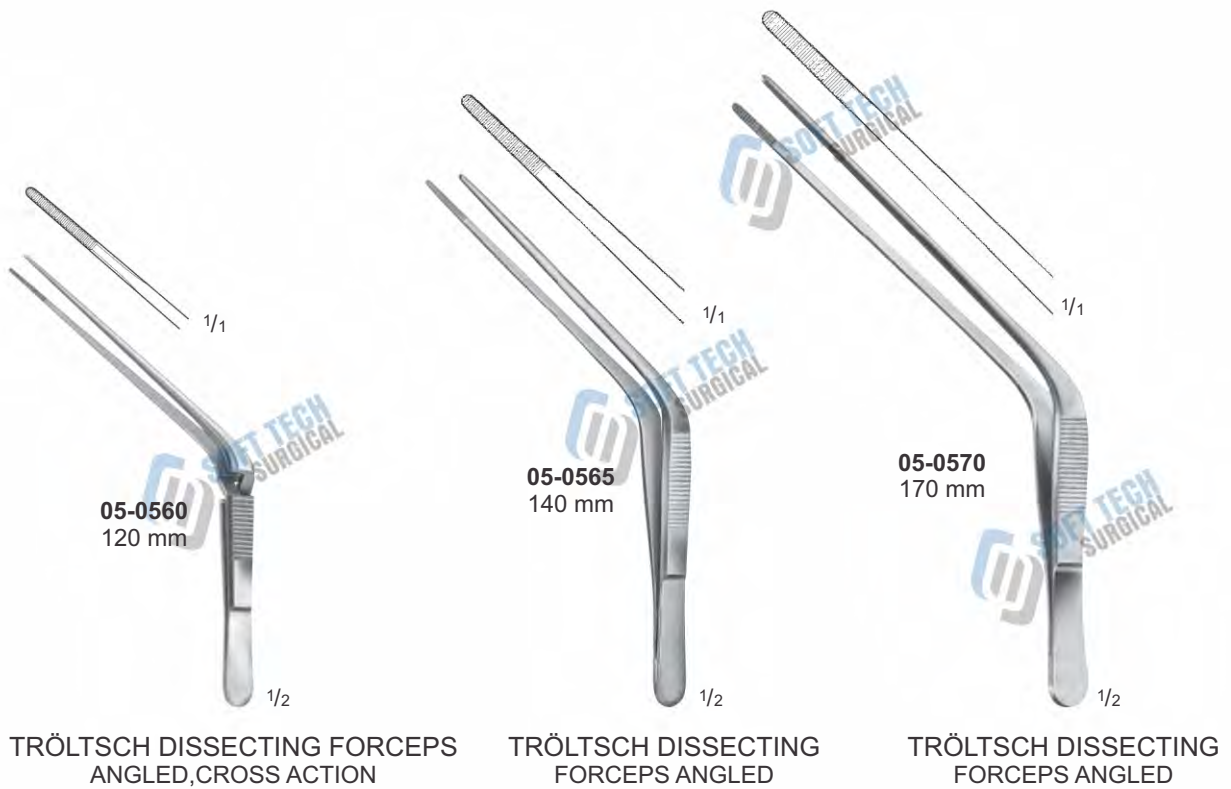



SOFT TECH Surgical, Manufacturer & Exporter of Quality Instruments



**BISHOP- HARMON  
IRIS DISSECTING  
FORCEPS  
05-0575  
85 mm**



**TISSUE FORCEPS  
05-0580  
80 mm**



**CASTROVIEJO  
TISSUE FORCEPS  
05-0585  
100 mm**

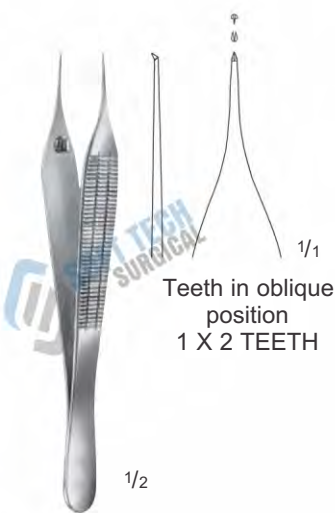

**MICRO-ADSON-  
BIEMER TISSUE  
FORCEPS  
05-0590  
120 mm**



**MICRO ADSON  
TISSUE FORCEPS  
05-0595  
120 mm**

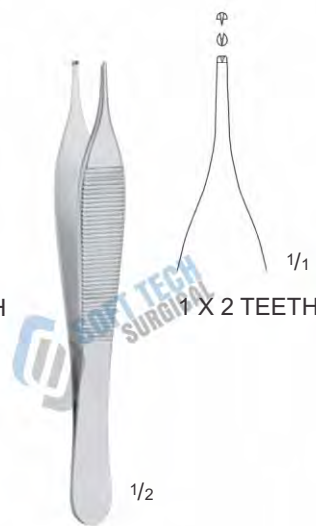

**ADSON  
TISSUE FORCEPS  
05-0600  
120 mm**

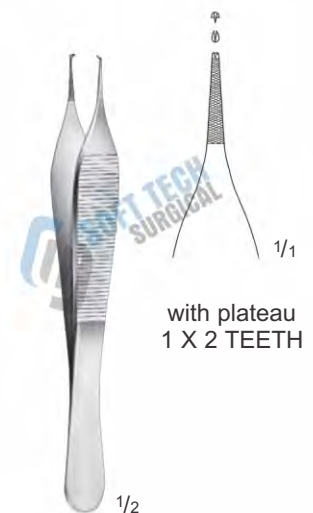

**ADSON  
05-0605  
120 mm**





MICRO ADSON  
TISSUE FORCEPS  
**05-0610**  
150 mm



ADSON TISSUE  
FORCEPS  
**05-0615**  
180 mm



JEFFERSON TISSUE  
FORCEPS  
**05-0620**  
180 mm

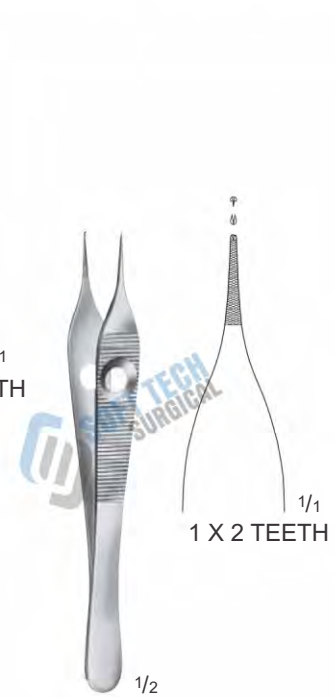

ADSON TISSUE  
FORCEPS  
**05-0625**  
120 mm



ADSON TISSUE  
FORCEPS  
**05-0630**  
120 mm



ADSON TISSUE  
FORCEPS MICRO  
**05-0635**  
120 mm



ADSON TISSUE  
FORCEPS STANDRED  
**05-0640**  
120 mm

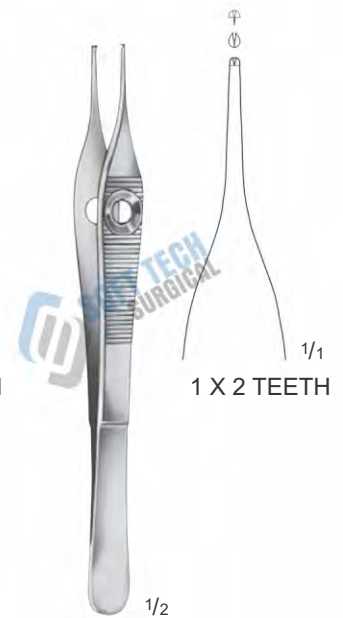

ADSON TISSUE  
FORCEPS  
**05-0645**  
150 mm

SOFT TECH Surgical, Manufacturer & Exporter of Quality Instruments



**HUDSON TISSUE FORCEPS**  
**05-0650**  
125 mm



**ADSON TISSUE FORCEPS**  
**05-0655**  
120 mm

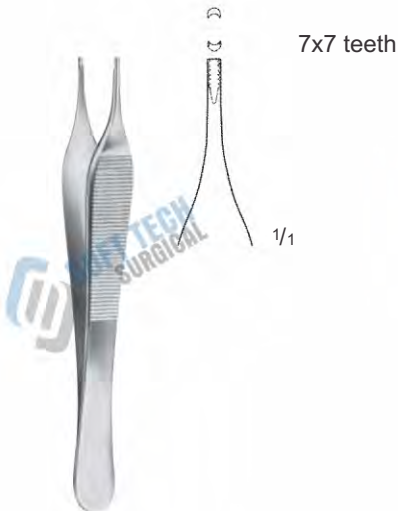

**ADSON-BROWN  
TISSUE FORCEPS**  
**05-0660**  
120 mm



**BROWN TISSUE  
FORCEP**



**GRAEFE TISSUE  
FORCEPS**  
**05-0675**  
110 mm



IRIS DISSECTING  
FORCEPS VERY DELICATE  
100 mm



TISSUE FORCEPS  
VERY DELICATE  
**05-0695**  
110 mm



TISSUE FORCEPS  
VERY DELICATE  
**05-0700**  
110 mm

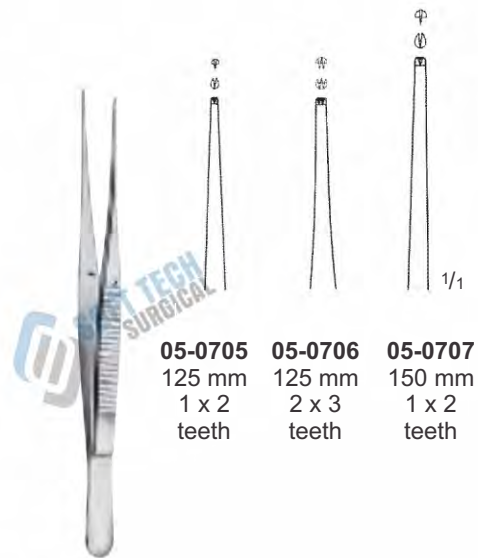

SEMKEN TISSUE  
FORCEPS

SOFT TECH Surgical, Manufacturer & Exporter of Quality Instruments



**GILLIES TISSUE  
FORCEPS**  
**05-0710**  
155 mm



**MC INDOE TISSUE  
FORCEPS**  
**05-0715**  
150 mm



**GERALD TISSUE  
FORCEPS**

<b>05-0720</b>	<b>05-0725</b>	<b>05-0730</b>
175 mm	175 mm	230 mm
1 x 2	1 x 2	1 x 2
teeth	teeth	teeth



**WAUGH TISSUE  
FORCEPS**

<b>05-0735</b>	<b>05-0736</b>	<b>05-0737</b>	<b>05-0738</b>
180 mm	200 mm	250 mm	305 mm
1 x 2	1 x 2	1 x 2	1 x 2
teeth	teeth	teeth	teeth

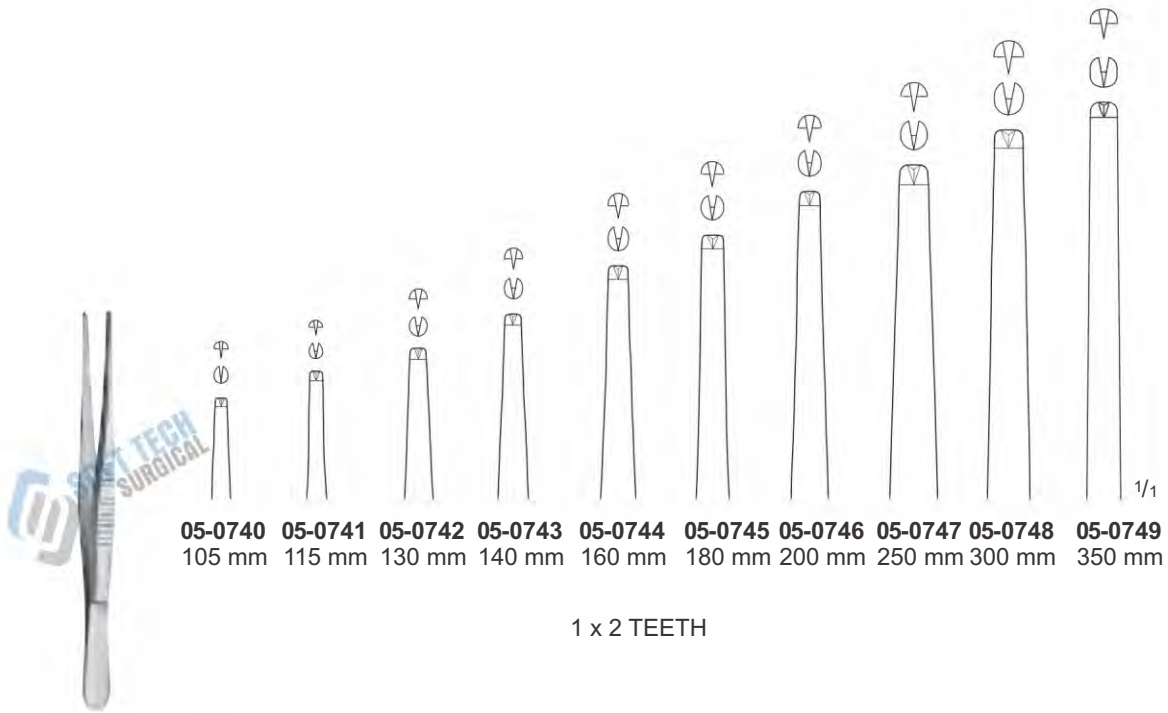

**05-0740** 105 mm   **05-0741** 115 mm   **05-0742** 130 mm   **05-0743** 140 mm   **05-0744** 160 mm   **05-0745** 180 mm   **05-0746** 200 mm   **05-0747** 250 mm   **05-0748** 300 mm   **05-0749** 350 mm

1 x 2 TEETH

TISSUE FORCEPS  
STANDARD PATTERN

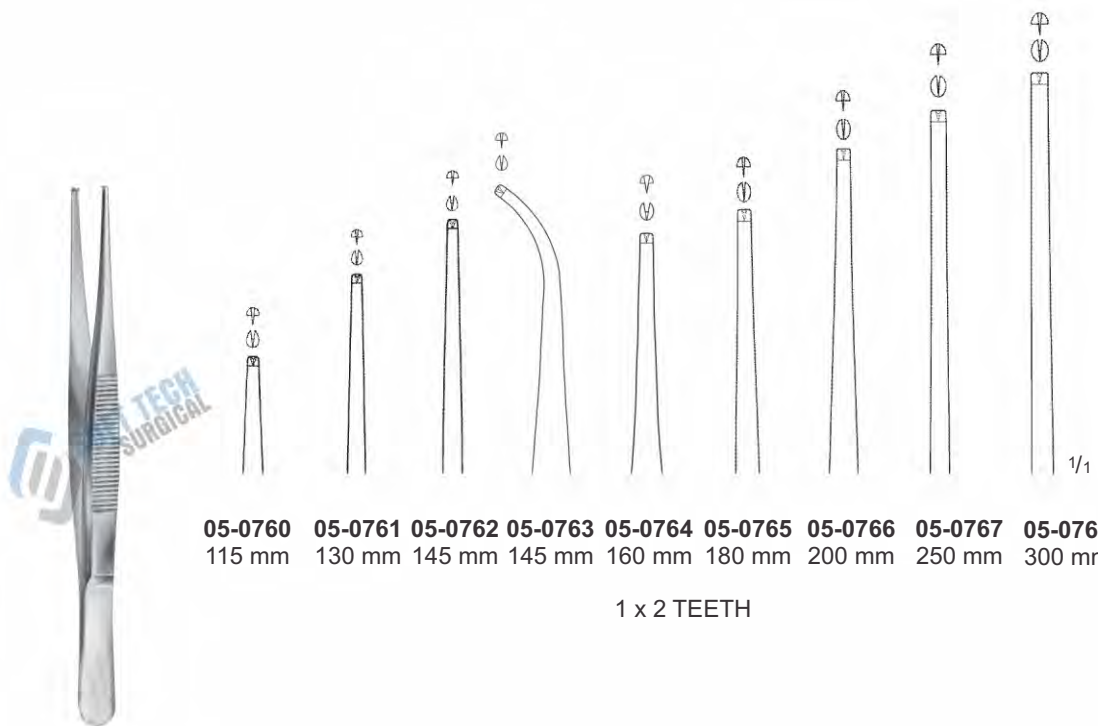

**05-0760** 115 mm   **05-0761** 130 mm   **05-0762** 145 mm   **05-0763** 145 mm   **05-0764** 160 mm   **05-0765** 180 mm   **05-0766** 200 mm   **05-0767** 250 mm   **05-0768** 300 mm

1 x 2 TEETH

TISSUE FORCEPS MEDIUM



SOFT TECH Surgical, Manufacturer & Exporter of Quality Instruments



**05-0770 05-0771 05-0772**  
145 mm 160 mm 200 mm

3 x 4 TEETH

TISSUE FORCEPS



4 x 5 teeth

1/2

TISSUE FORCEPS

**05-0780**  
145 mm



4 x 5 teeth

1/1

1/2

OFFICER TISSUE FORCEPS  
**05-0785**  
150 mm

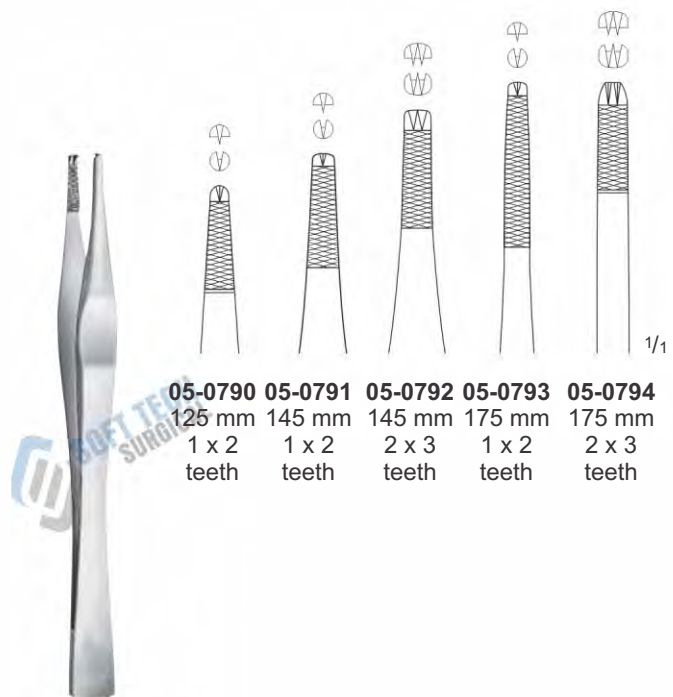

<b>05-0790</b> 125 mm 1 x 2 teeth	<b>05-0791</b> 145 mm 1 x 2 teeth	<b>05-0792</b> 145 mm 2 x 3 teeth	<b>05-0793</b> 175 mm 1 x 2 teeth	<b>05-0794</b> 175 mm 2 x 3 teeth
--	--	--	--	--

1/1

LANE TISSUE FORCEPS EXTRA STRONG



TREVES TISSUE FORCEPS



BONNEY TISSUE FORCEPS  
05-0805  
175 mm

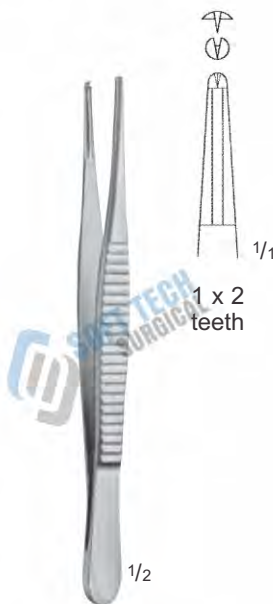

JACKSON- BURROWS  
TISSUE FORCEPS  
05-0810  
140 mm

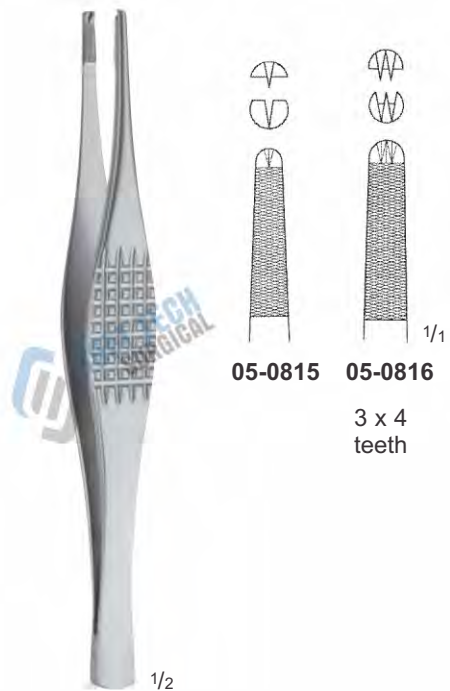

RAMSEY TISSUE FORCEPS  
180 mm

SOFT TECH Surgical, Manufacturer & Exporter of Quality Instruments



**05-0820**  
150 mm  
4 x 5  
teeth

**05-0821**  
200 mm  
4 x 5  
teeth

**ADLERKREUTZ  
TISSUE FORCEPS**



**05-0825**  
180 mm  
3 x 4  
teeth

**05-0826**  
200 mm  
3 x 4  
teeth

**05-0827**  
250 mm  
4 x 5  
teeth

**STILLE-BARRAYA  
TISSUE FORCEPS**



**RUSSIAN PATTERN  
TISSUE FORCEPS**  
**05-0830**  
150 mm

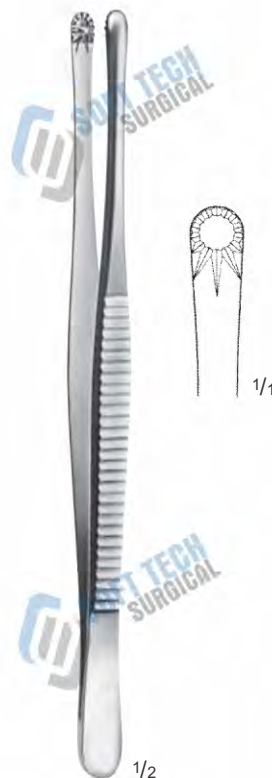

**RUSSIAN PATTERN  
TISSUE FORCEPS**  
**05-0835**  
200 mm



**SELMAN FORCEPS**  
**05-0840**  
155 mm



**TUTTLE LUNG  
 DISSECTING FORCEPS**  
**05-0845**  
 230 mm

**NELSON LUNG  
 GRASPING FORCEPS**  
**05-0850**  
 230 mm

**DUVAL INTESTINAL  
 FORCEPS**  
**05-0855**  
 140 mm

**DENIS-BROWNE  
 INTESTINAL FORCEPS**  
 190 mm



SOFT TECH Surgical, Manufacturer & Exporter of Quality Instruments



**SPLINTER FORCEPS**  
**05-0865**  
80 mm



**FEILCHENFELD  
SPLINTER FORCEPS**

**05-0870 05-0871 05-0872**  
80 mm 95 mm 115 mm



**HUNTER SPLINTER  
FORCEPS**  
**05-0875**  
105 mm



**STIEGLITZ SPLINTER  
FORCEPS STRAIGHT**  
**05-0880**  
140 mm



**STIEGLITZ SPLINTER  
FORCEPS CURVED**  
**05-0885**  
140 mm



**PEET SPLINTER FORCEPS CURVE**  
**05-0890**  
120 mm





**SOFT TECH  
SURGICAL**

## **General Surgery Instruments Catalogue**

### **SOFT TECH Surgical**

Muslim Town, Airport Road  
Kotli Behram, Sialkot 51310  
Pakistan.

Email : [info@softtechsurgical.com](mailto:info@softtechsurgical.com)  
Website : [www.softtechsurgical.com](http://www.softtechsurgical.com)

Phone : +92 52 3573488  
+92 52 3242929  
+92 52 4264934  
Fax : +92 52 3242929

 +92 336 4770459