



SOFT TECH  
SURGICAL

04  
Scissors



SOFT TECH Surgical, Manufacturer & Exporter of Quality Instruments

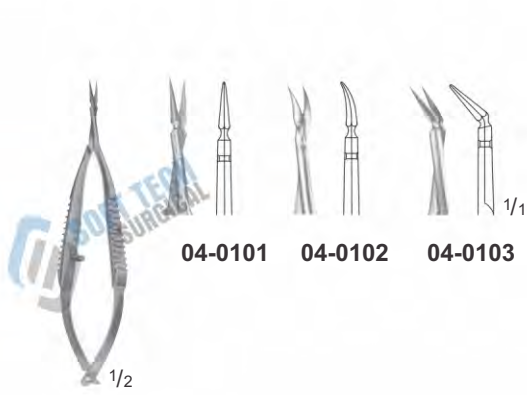

**VANNAS EYE SCISSORS**  
85 mm



**CASTROVIEJO EYE SCISSORS  
ANGLED TO SIDE**  
95 mm



**MC CLURE EYE SCISSORS**  
**04-0110**  
95 mm

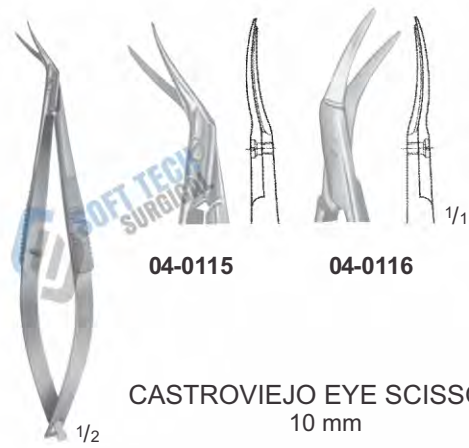

**CASTROVIEJO EYE SCISSORS**  
10 mm



**EYE SCISSORS**  
105 mm



**WECKER EYE SCISSORS**  
**04-0125**  
110 mm



**NOYES EYE SCISSORS**  
**04-0130**  
125 mm

General Surgery  
Instruments  
Micro Scissors (spring Type) With  
Flat Handles & Cross-serration

SOFT TECH Surgical, Manufacturer & Exporter of Quality Instruments



04-0135

04-0136

04-0140

04-0141

YASARGIL MICRO  
SCISSORS, SPRING TYPE  
185 mm  
04-0145

JACOBSON MICRO  
SCISSORS, SPRING TYPE  
185 mm  
04-0146

VANNAS MICRO SCISSORS  
SPRING TYPE  
160 mm

MILLESII MICRO SCISSORS  
BLADES SERRATED  
160 mm

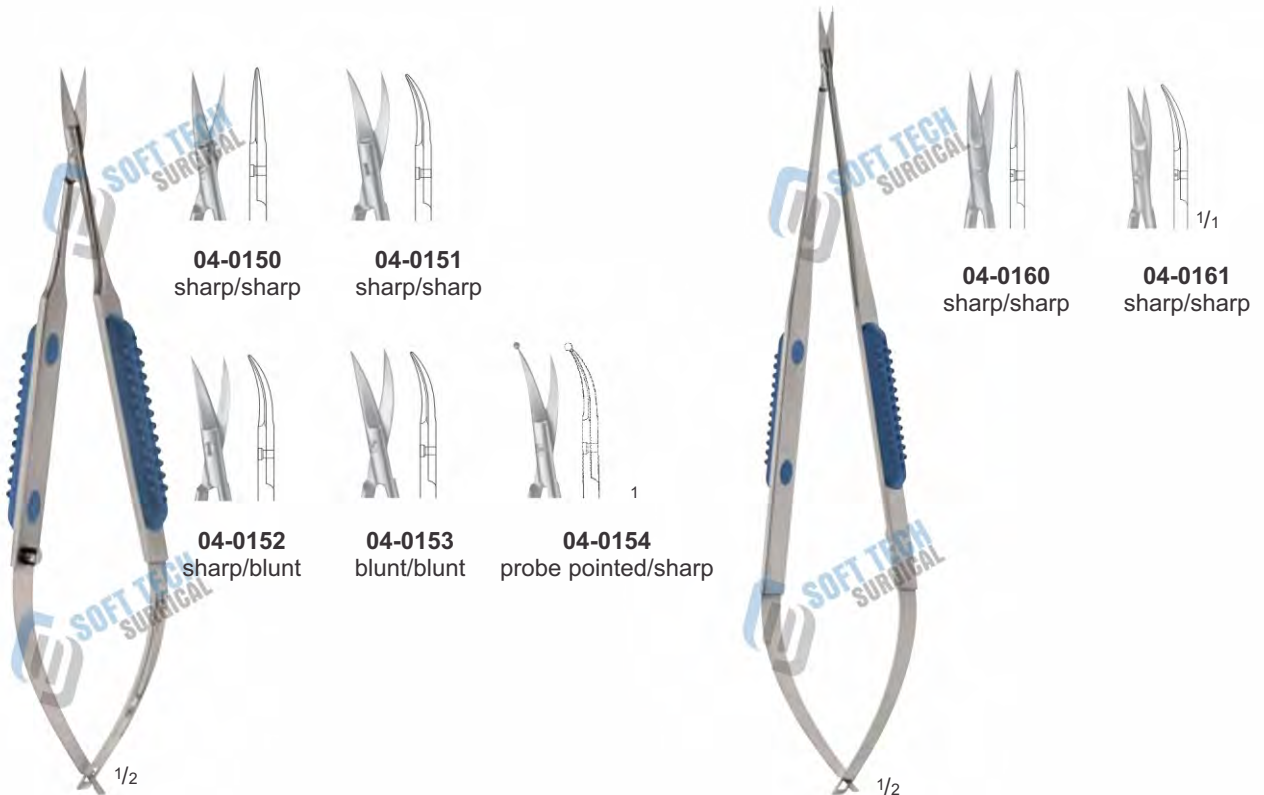

04-0150  
sharp/sharp

04-0151  
sharp/sharp

04-0160  
sharp/sharp

04-0161  
sharp/sharp

04-0152  
sharp/blunt

04-0153  
blunt/blunt

04-0154  
probe pointed/sharp

MÜLLER MICRO SCISSORS  
120 mm

MÜLLER MICRO SCISSORS  
170 mm

SOFT TECH Surgical, Manufacturer & Exporter of Quality Instruments



**MICRO SCISSORS**  
FINE, ANGLED  
165 mm



**04-0170**  
25°



**04-0171**  
45°



**04-0172**  
60°



**04-0173**  
90°



**04-0174**  
125°



**04-0180**  
25°



**04-0181**  
45°



**04-0182**  
60°



**04-0183**  
90°



**04-0184**  
125°



General Surgery  
Instruments  
Micro Scissors (spring Type)  
With Round Handles

SOFT TECH Surgical, Manufacturer & Exporter of Quality Instruments



MICRO SCISSORS  
04-0190  
180 mm



MICRO FORCEPS  
04-0195  
180 mm



MICRO SCISSORS  
04-0200  
180 mm



MICRO SUTURE  
SCISSORS  
04-0205  
180 mm

SOFT TECH Surgical, Manufacturer & Exporter of Quality Instruments



**IRIS SCISSORS  
DELICATE  
90 mm**



**IRIS SCISSORS  
DELICATE  
100 mm**



**IRIS ACISSORS  
DELICATE  
120 mm**

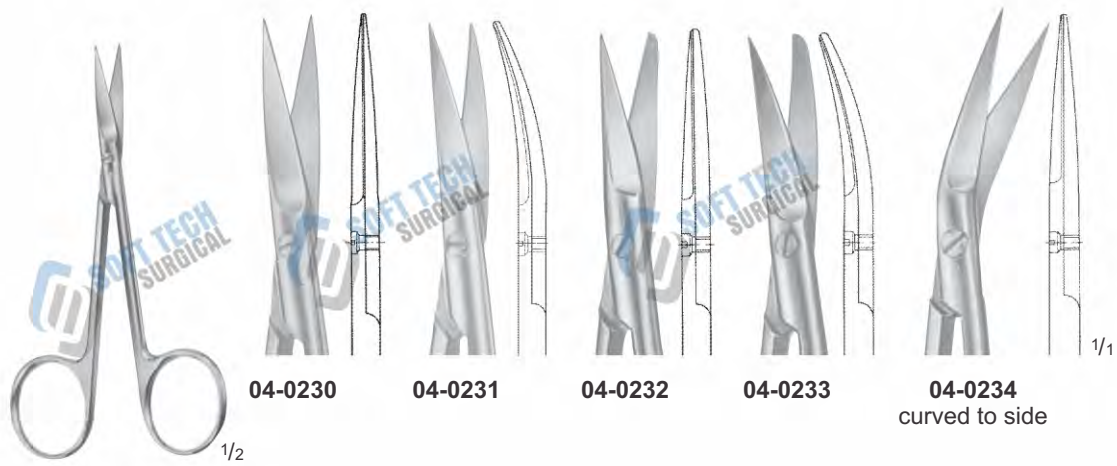

**IRIS SCISSORS  
110 mm**

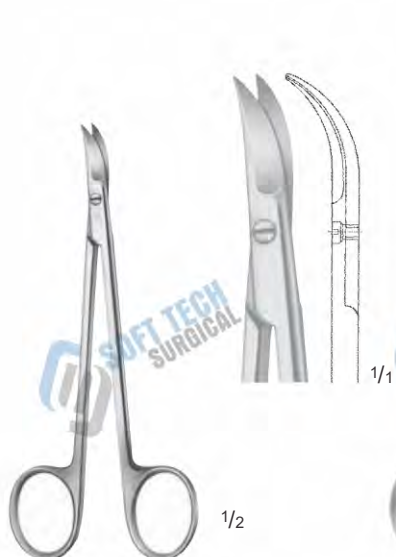

CHADWICK DELICATE  
SCISSORS  
**04-0240**  
15 mm



QUINBY SCISSORS  
**04-0245**  
130 mm



DISSECTING SCISSORS  
**04-0250**  
110 mm



VESSEL SCISSORS  
ONE BLADE PROBE  
POINTED  
**04-0255**  
120 mm



PERWITZSCHKY  
SALIVAL SCISSORS  
**04-0260**  
100 mm



SOFT TECH Surgical, Manufacturer & Exporter of Quality Instruments



**LA GRANGE SCISSORS**  
**04-0265**  
110 mm

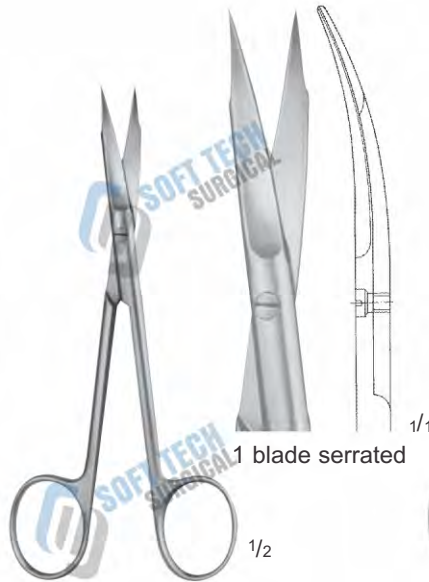

**GOLDMAN-FOX SCISSORS**  
**04-0270**  
130 mm

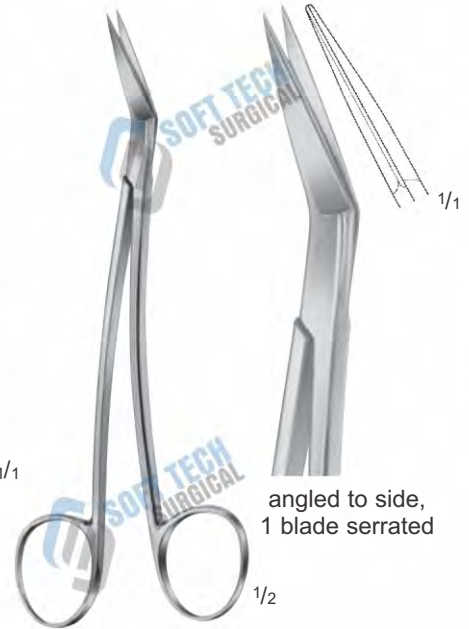

**LOCKLIN SCISSORS**  
**04-0275**  
155 mm



**JOSEPH SCISSORS**  
150 mm

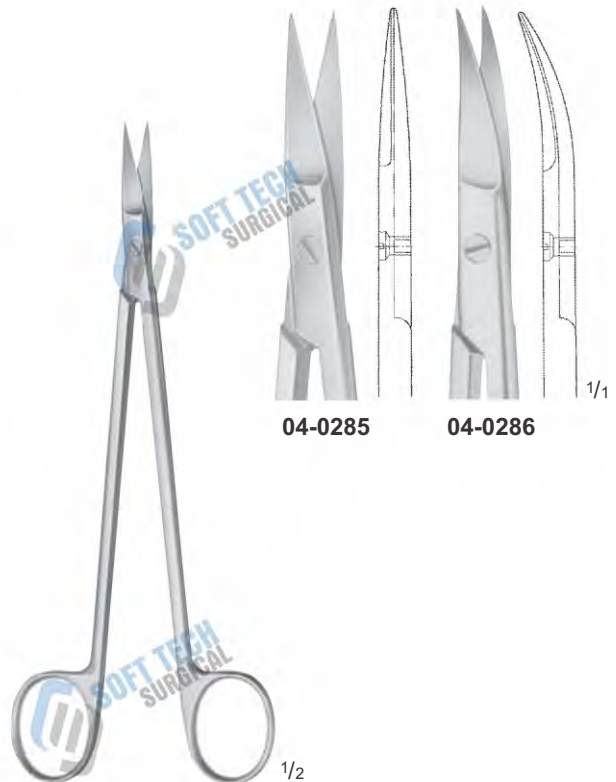
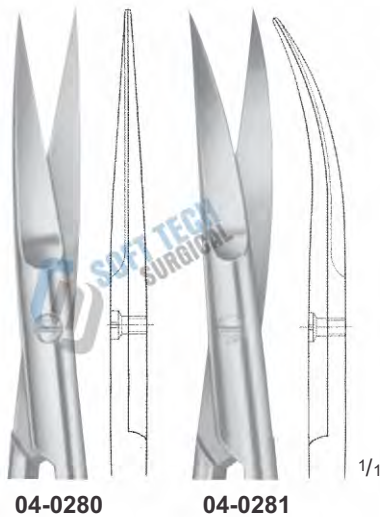

**KELLY SCISSORS**  
175 mm

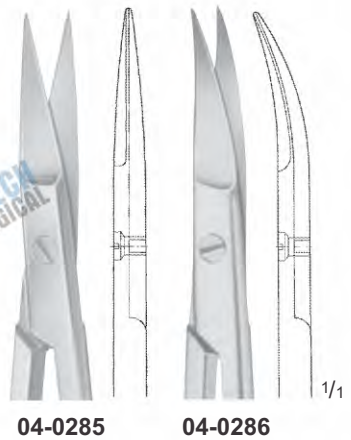





OPERATING SCISSORS  
SHAPE/BLUNT (STR)

- |                |                |                |                |                |                |                |                |                |
|----------------|----------------|----------------|----------------|----------------|----------------|----------------|----------------|----------------|
| <b>04-0290</b> | <b>04-0291</b> | <b>04-0292</b> | <b>04-0293</b> | <b>04-0294</b> | <b>04-0295</b> | <b>04-0296</b> | <b>04-0297</b> | <b>04-0298</b> |
| 105 mm         | 115 mm         | 130 mm         | 145 mm         | 150 mm         | 165 mm         | 175 mm         | 185 mm         | 200 mm         |



OPERATING SCISSORS  
SHAPE/BLUNT (CVD)

- |                |                |                |                |                |                |                |
|----------------|----------------|----------------|----------------|----------------|----------------|----------------|
| <b>04-0300</b> | <b>04-0301</b> | <b>04-0302</b> | <b>04-0303</b> | <b>04-0304</b> | <b>04-0305</b> | <b>Bc-0306</b> |
| 115 mm         | 130 mm         | 145 mm         | 150 mm         | 165 mm         | 175 mm         | 185 mm         |

SOFT TECH Surgical, Manufacturer & Exporter of Quality Instruments

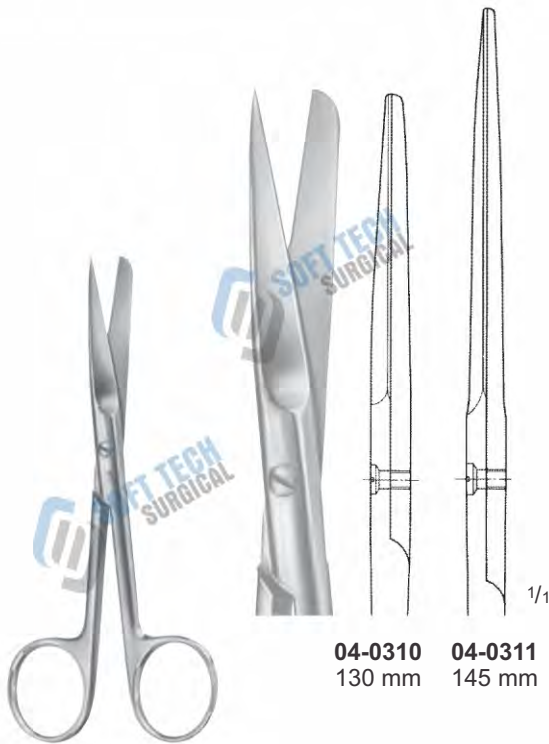

**OPERATING SCISSORS**  
slender patterns (STR)

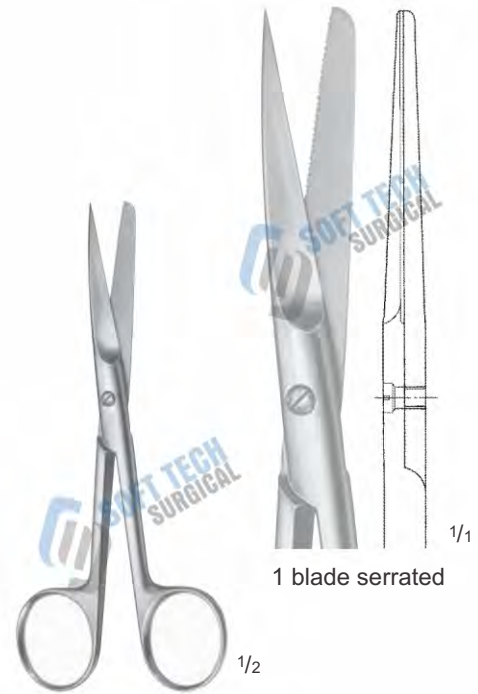

**OPERATING SCISSORS**  
Slender patterns (STR)  
**04-0315**  
130 mm



**OPERATING SCISSORS**  
slender patterns (CVD)

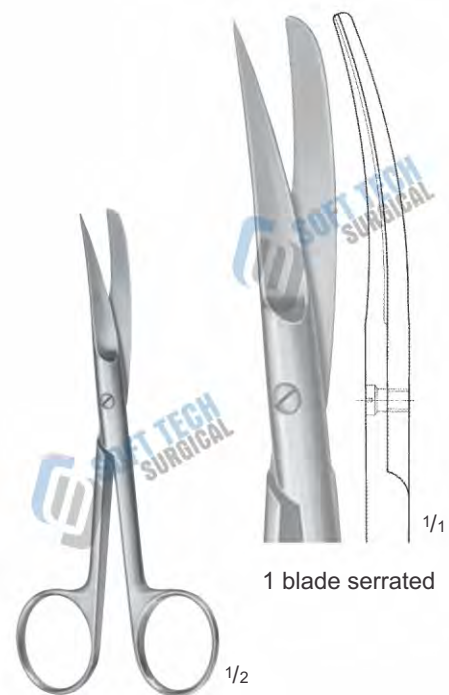

**OPERATING SCISSORS**  
Slender patterns (STR)  
**04-0325**  
130 mm



OPERATING SCISSORS  
BLUNT/BLUNT (STR)

100 mm	<b>05-0330</b>
115 mm	<b>05-0331</b>
130 mm	<b>05-0332</b>
145 mm	<b>05-0333</b>
155 mm	<b>05-0334</b>
160 mm	<b>05-0335</b>
180 mm	<b>05-0336</b>
200 mm	<b>05-0337</b>



OPERATING SCISSORS  
SHARP/BLUNT (STR)

<b>05-0340</b>
<b>05-0341</b>
<b>05-0342</b>
<b>05-0343</b>
<b>05-0344</b>
<b>05-0345</b>
<b>05-0346</b>
<b>05-0347</b>



OPERATING SCISSORS  
SHARP/SHARP (STR)

<b>05-0350</b>
<b>05-0351</b>
<b>05-0352</b>
<b>05-0353</b>
<b>05-0354</b>
<b>05-0355</b>
<b>05-0356</b>
<b>05-0357</b>



OPERATING SCISSORS  
BLUNT/BLUNT (CVD)

100 mm	<b>05-0360</b>
115 mm	<b>05-0361</b>
130 mm	<b>05-0362</b>
145 mm	<b>05-0363</b>
155 mm	<b>05-0364</b>
160 mm	<b>05-0365</b>
180 mm	<b>05-0366</b>
200 mm	<b>05-0367</b>



OPERATING SCISSORS  
SHARP/BLUNT (CVD)

<b>05-0370</b>
<b>05-0371</b>
<b>05-0372</b>
<b>05-0373</b>
<b>05-0374</b>
<b>05-0375</b>
<b>05-0376</b>
<b>05-0377</b>



OPERATING SCISSORS  
SHARP/SHARP (CVD)

<b>05-0380</b>
<b>05-0381</b>
<b>05-0382</b>
<b>05-0383</b>
<b>05-0384</b>
<b>05-0385</b>
<b>05-0386</b>
<b>05-0387</b>



SOFT TECH Surgical, Manufacturer & Exporter of Quality Instruments

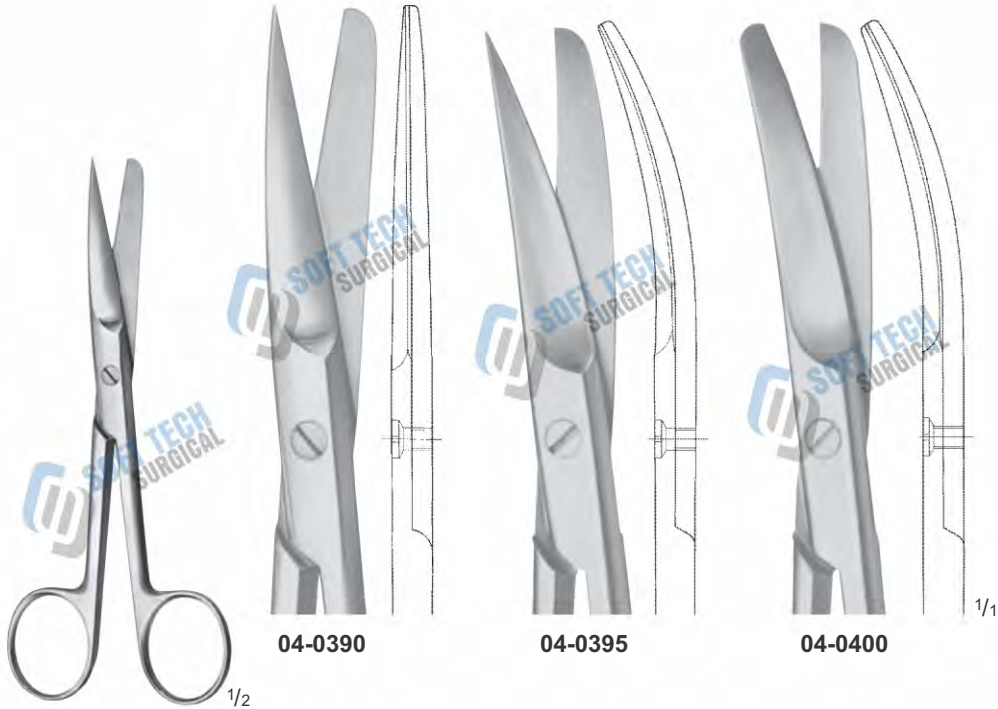

**DEAVER SCISSORS**  
145 mm



**INCISION SCISSORS  
PROBE POINTED**

**04-0405** 130 mm  
**04-0406** 145 mm  
**04-0407** 165 mm

**04-0410**  
**SYSTRUNK** Nail splitting scissors  
130 mm



**GRAEFE SCISSORS**  
**04-0415**  
100 mm



**STRABISMUS SCISSORS**  
**04-0420**   **04-0425**  
115 mm



**KILNER DELICATE SCISSORS**  
**04-0430**  
15 mm

SOFT TECH Surgical, Manufacturer & Exporter of Quality Instruments



**COTTLE-MASING  
SCISSORS**  
105 mm



**SCOTTLE-KNAPP SCISSOR**  
105 mm



**FOMON LOWER  
LATERAL SCISSORS**



**LANDOLT ENUCLEATION SCISSORS**  
120 mm





STEVENS VASCULAR  
TENDON SCISSORS  
100 mm

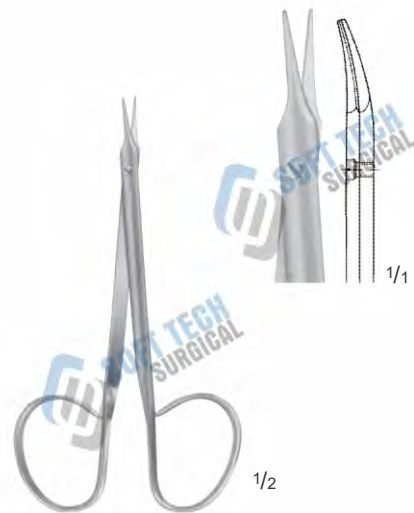

STEVENS VASCULAR  
TENDON SCISSORS  
04-0480  
110 mm

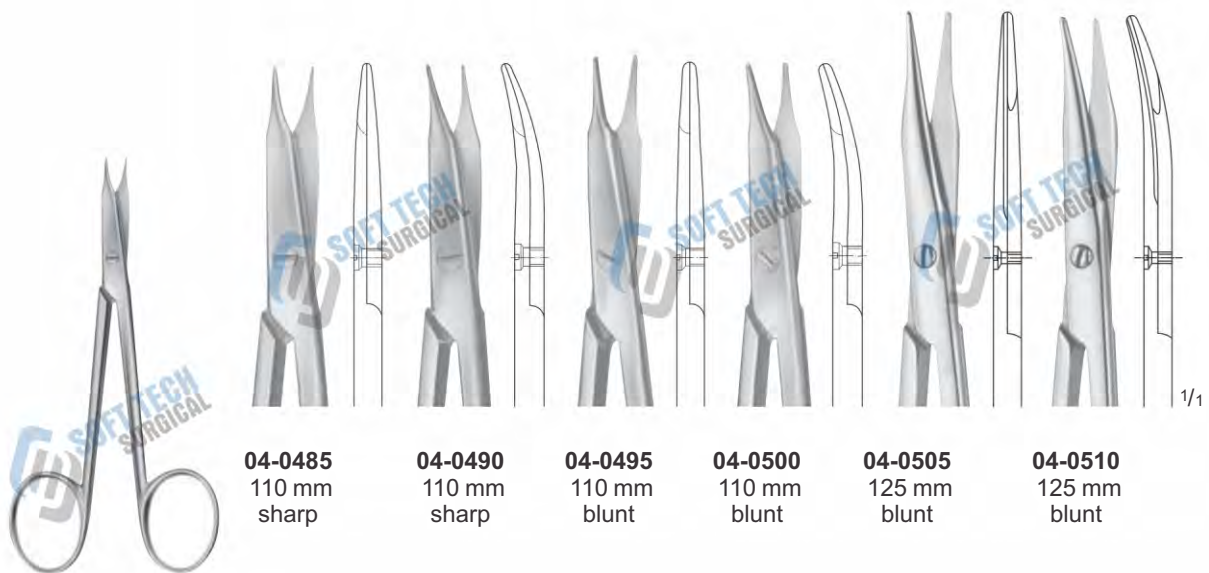

STEVENS Tenotomy Scissors

SOFT TECH Surgical, Manufacturer & Exporter of Quality Instruments



**04-0515**  
125 mm

**04-0520**  
150 mm

**KILNER DISSECTING  
SCISSORS  
FLAT POINTS**

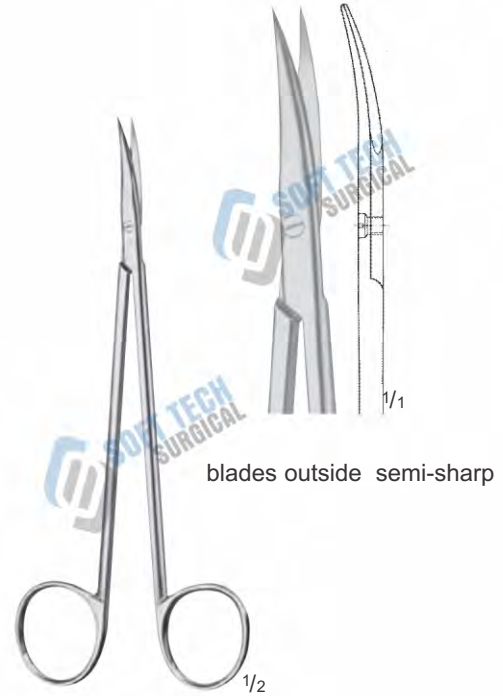

blades outside semi-sharp

**NERVE DISSECTING  
SCISSORS**  
**04-0525**  
150 mm

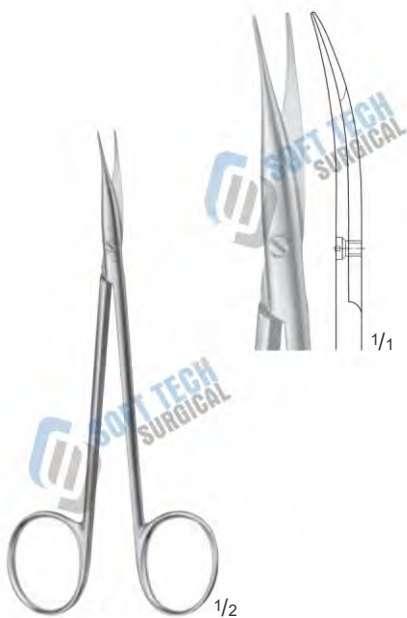

**JAMESON- WERBER SCISSORS**  
**04-0530**  
130 mm



**JAMESON SCISSORS**  
**04-0535**  
150 mm



REYNOLDS SCISSORS



POTTS SCISSORS  
04-0550  
180 mm

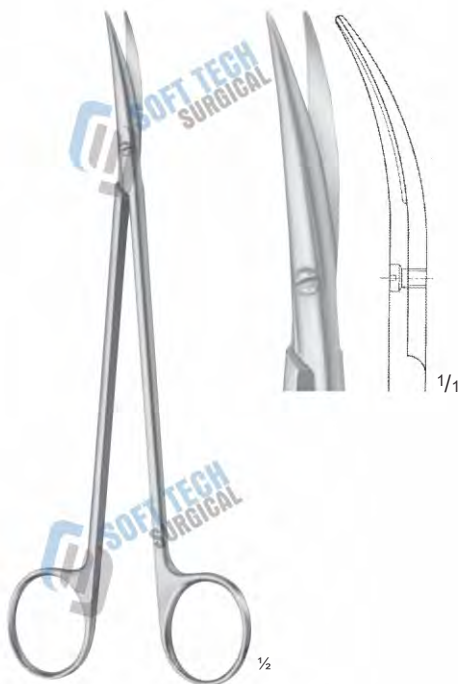

DE BAKEY ARTERIOTOMY-SCISSORS  
04-0555  
175 mm



TOENNIS DISSECTING  
SCISSORS 175 mm



SOFT TECH Surgical, Manufacturer & Exporter of Quality Instruments



**GORNEY SCISSORS  
SERRATED BLADES**



**04-0580  
CARTILAGE SCISSORS  
185 mm**

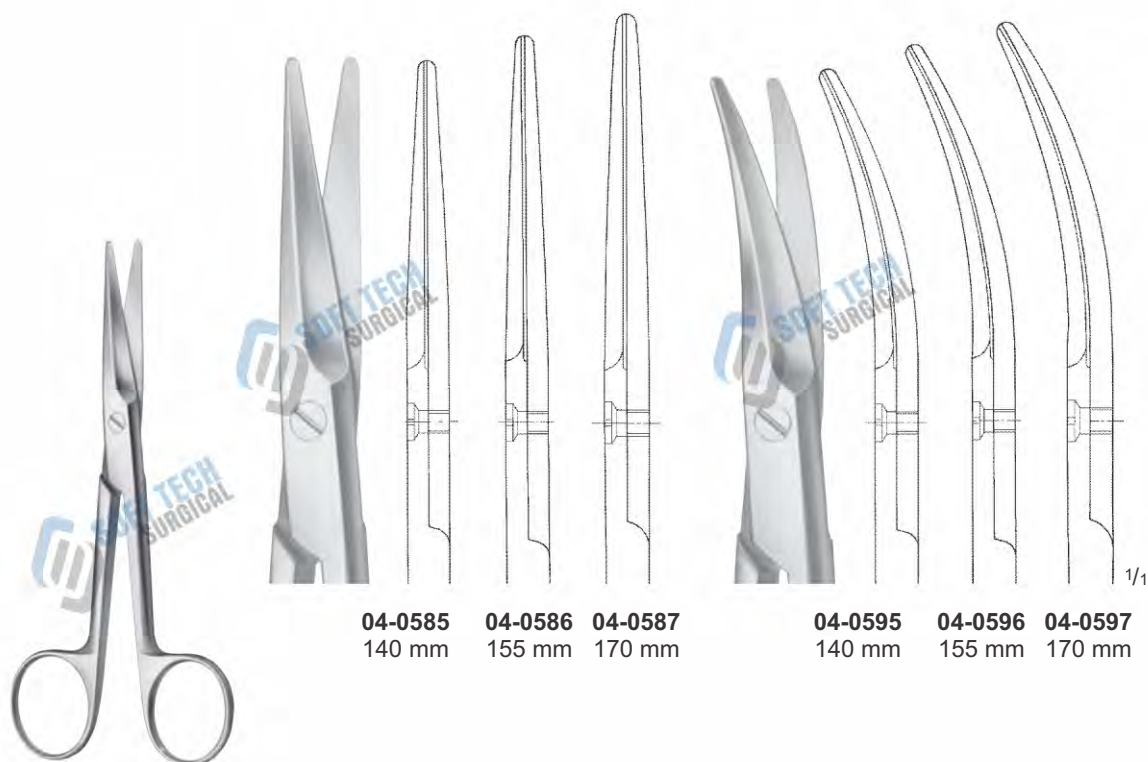

MAYO SCISSORS

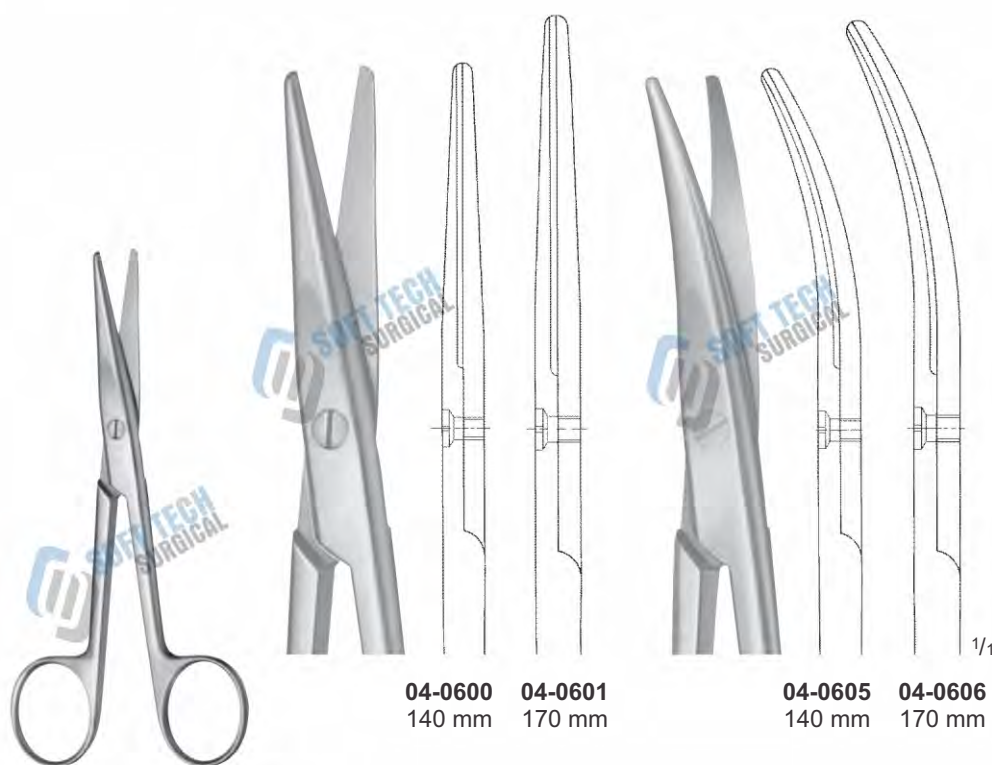

MAYO-STILLE SCISSORS  
04-570 - 04-575

SOFT TECH Surgical, Manufacturer & Exporter of Quality Instruments



MAYO-STILLE SCISSORS  
CHAMFERED BLADES



MAYO DISSECTING SCISSORS  
CHAMFERED BLADE





MAYO-NOBLE SCISSORS  
BROAD PATTERN  
170 mm



04-0630



04-0635



MAYO-HARRINGTON  
SCISSORS  
230 mm



04-0640



04-0645

SOFT TECH Surgical, Manufacturer & Exporter of Quality Instruments



04-0650

04-0655

1/1

04-0660

04-0665

1/1

1/2

1/2

MAYO-STILLE SCISSORS  
150 mm

MAYO-LEXER SCISSORS  
NARROW PATTERN  
165 mm



1/2

1/1

04-0675  
165 mm

04-0676  
200 mm

04-0680  
165 mm

04-0681  
200 mm

04-0682  
210 mm

1/1

MAYO-LEXER SCISSORS  
STANDARD PATTERN  
04-0670  
165 mm

MAYO SCISSORS



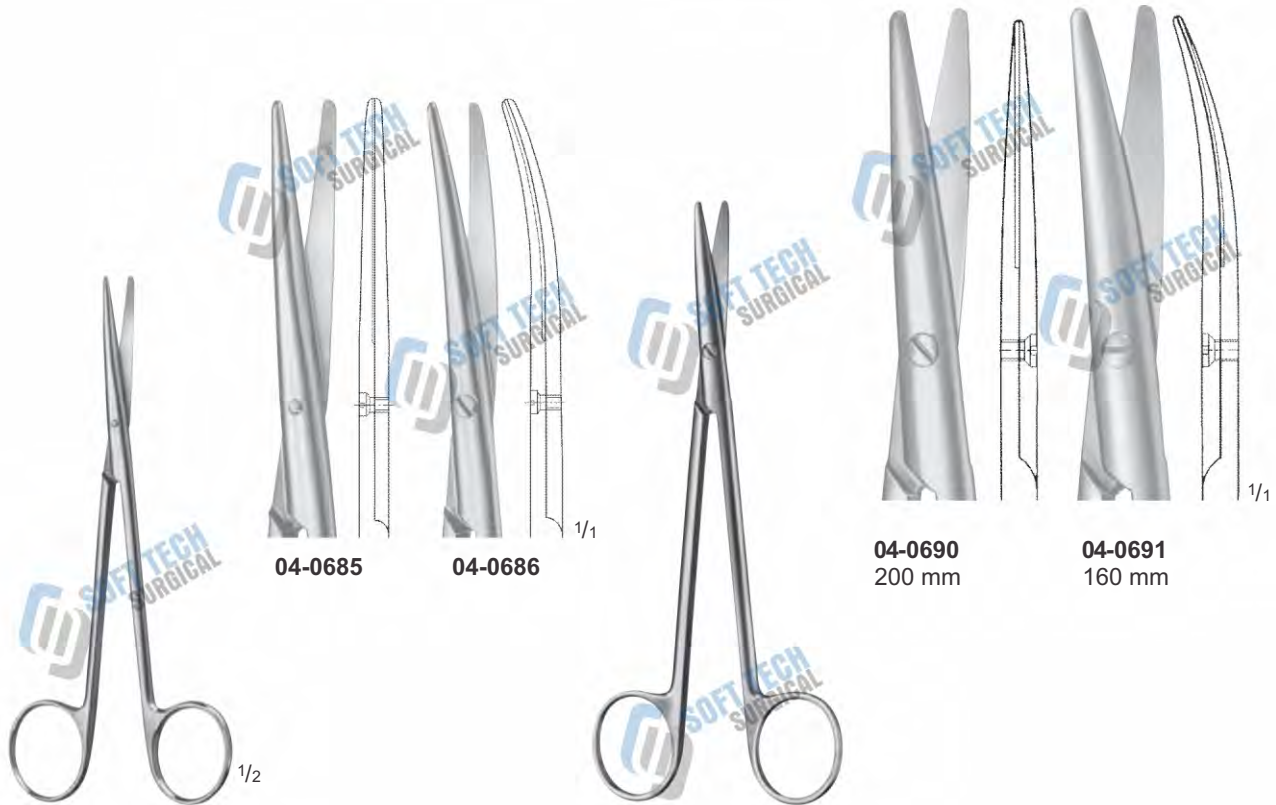

04-0685

04-0686

04-0690  
200 mm

04-0691  
160 mm

BABY-METZENBAUM  
SCISSORS  
145 mm

METZENBAUM SCISSORS



04-0695  
145 mm

04-0696  
180 mm

04-0697  
200 mm

04-0700  
145 mm

04-0701  
180 mm

04-0702  
200 mm

METZENBAUM SCISSORS



SOFT TECH Surgical, Manufacturer & Exporter of Quality Instruments



**04-0710** 230 mm  
**04-0711** 250 mm  
**04-0712** 280 mm  
**04-0713** 305 mm



**NELSON-METZENBAUM SCISSORS**



**04-0720** 230 mm  
**04-0721** 250 mm  
**04-0722** 280 mm  
**04-0723** 305 mm  
**04-0724** 350 mm



WELLER SCISSORS  
HEAVY PATTERN  
04-0730  
280 mm

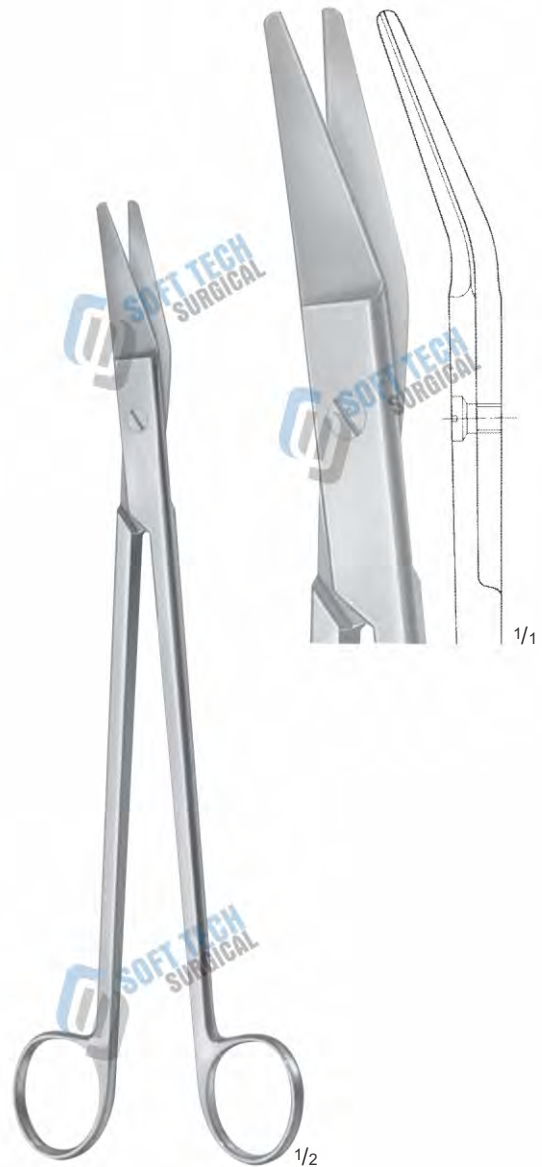

RESANO SCISSORS  
04-0735  
250 mm

SOFT TECH Surgical, Manufacturer & Exporter of Quality Instruments



**IRIS SCISSORS  
SUPER CUT  
110 mm**

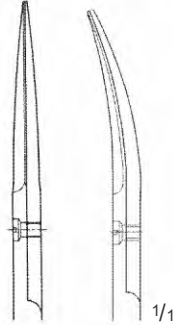

**04-0740 04-0745**  
sharp sharp  
One Blade Serrated  
Titanium Black Coated Rings



**JAMESON SCISSORS  
SUPER CUT**

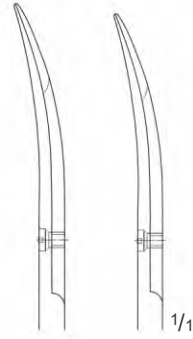

**04-0750 04-0755**  
130 mm 150 mm  
blunt blunt  
One Blade Serrated  
Titanium Black Coated Rings



**JOSEPH SCISSORS  
SUPER CUT  
150 mm**

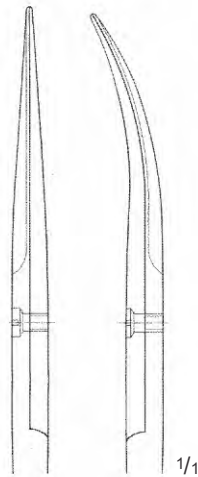

**04-0760 04-0765**  
sharp sharp  
One Blade Serrated  
Titanium Black Coated Rings



**GORNEY SCISSORS  
SUPER CUT  
195 mm**

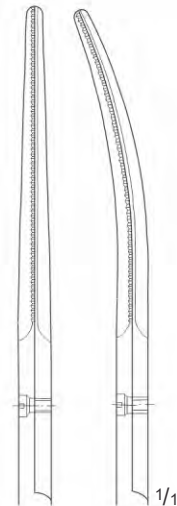

**04-0770 04-0775**  
blunt blunt  
One Blade Serrated  
Titanium Black Coated Rings





MAYO SCISSORS  
SUPER CUT  
165 mm

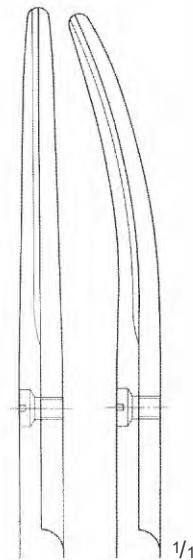

04-0780 04-0785  
One Blade Serrated



BABY-METZENBAUM  
SUPER CUT  
115 mm

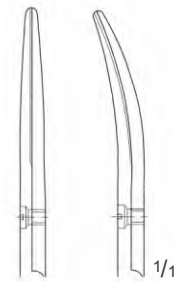

04-0790 04-0795  
One Blade Serrated



METZENBAUFINO SCISSORS  
SUPER CUT

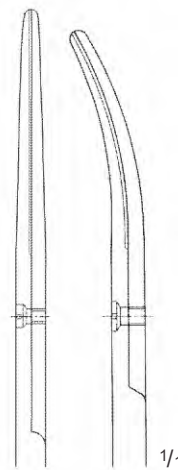

04-0800 04-0805  
145 mm 180 mm  
One Blade Serrated

SOFT TECH Surgical, Manufacturer & Exporter of Quality Instruments



**IRIS SCISSORS**  
TC Carbide  
110 mm

**GOLDMAN-FOX SCISSORS**  
TC Carbide  
**04-0820**  
130 mm

**IRIS SCISSORS**  
TC Carbide  
120 mm

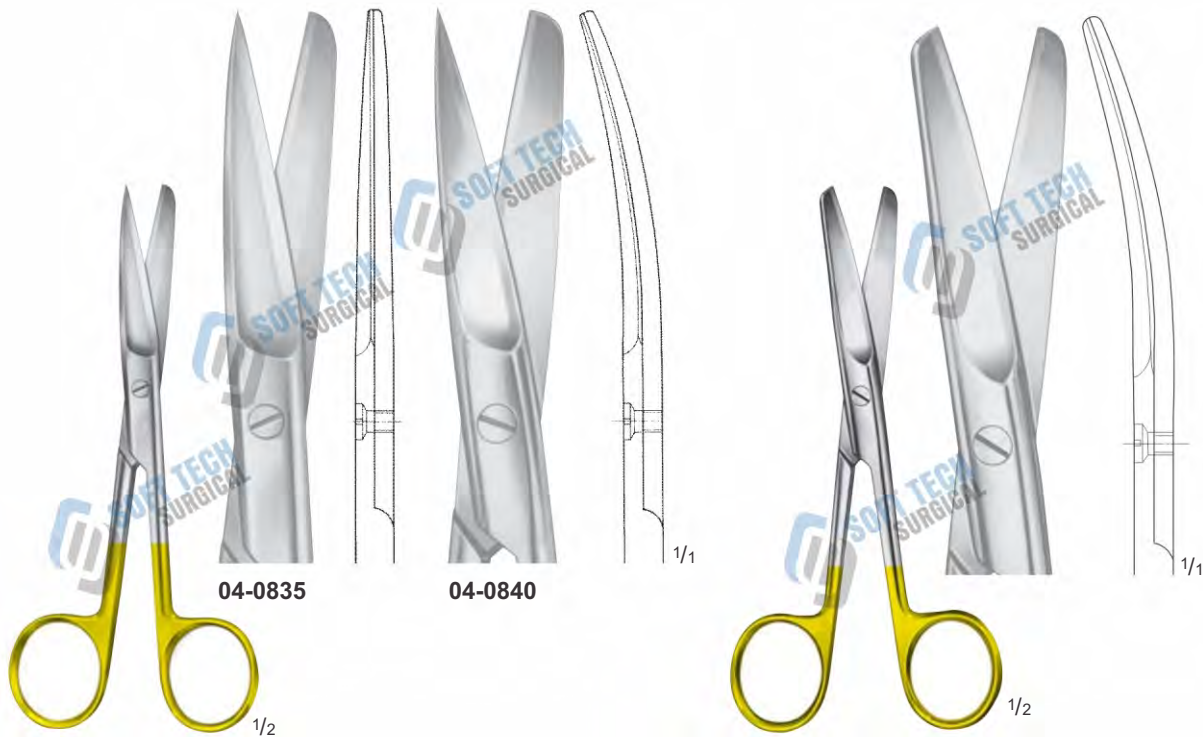

**OPERATING SCISSORS**  
TC Carbide  
145 mm

**OPERATING SCISSORS**  
TC Carbide  
**04-0845**  
145 mm

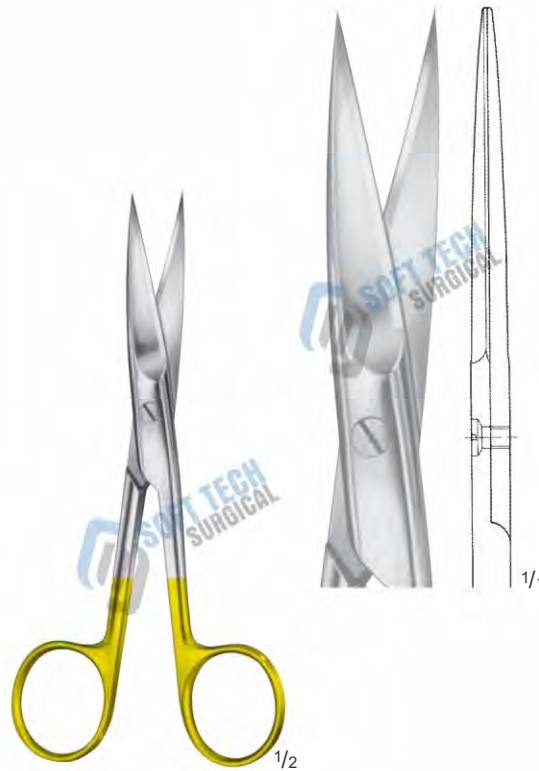

OPERATING SCISSORS  
TC Carbide  
04-0850  
145 mm

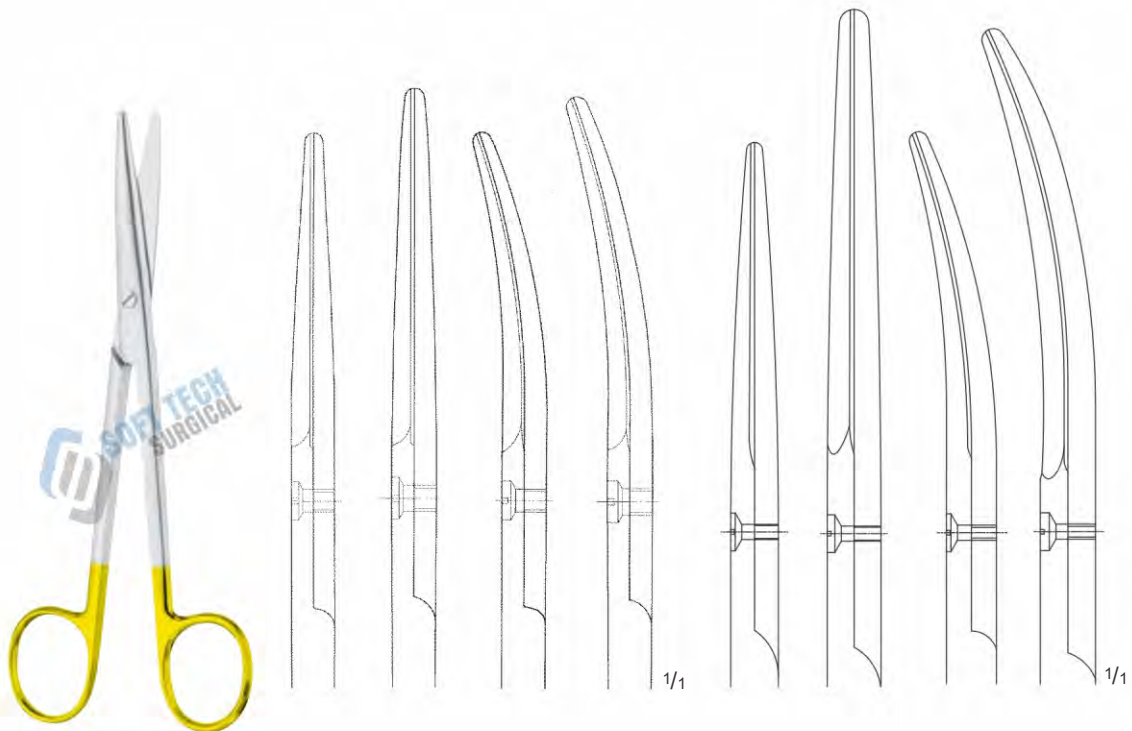

MAYO SCISSORS  
TC Carbide

04-0860	04-0861	04-0862	04-0863	04-0870	04-0871	04-0872	04-0873
140 mm	170 mm	140 mm	170 mm	170 mm	230 mm	170 mm	230 mm



SOFT TECH Surgical, Manufacturer & Exporter of Quality Instruments



**MAYO-LEXER SCISSORS**  
TC Carbide  
**04-0880**  
165 mm

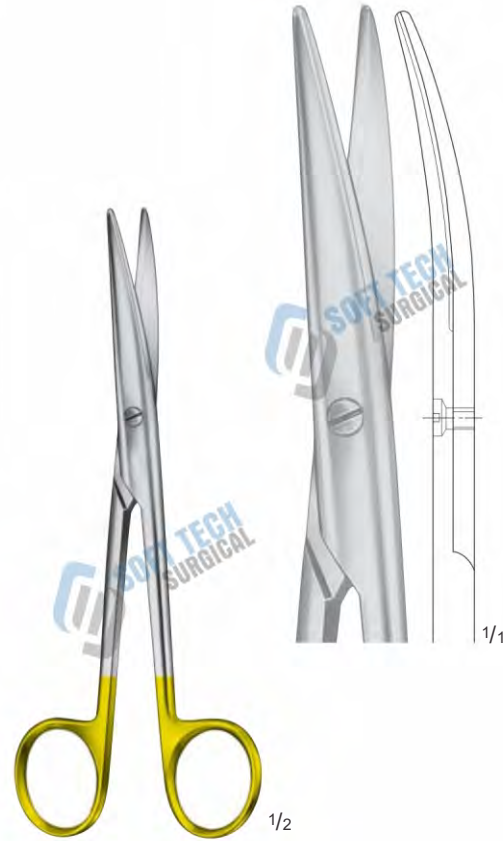

**MAYO-LEXER SCISSORS**  
TC Carbide  
**04-0885**  
165 mm



**STRABISMU SCISSORS**  
TC Carbide  
15 mm

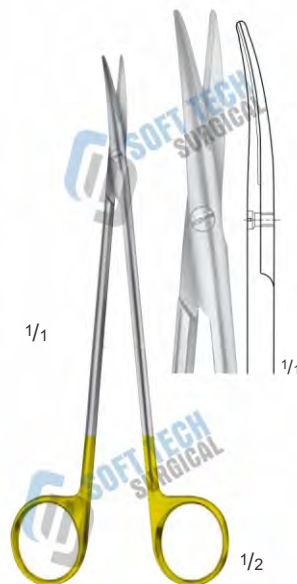

**TÖNNIS SCISSORS**  
TC Carbide  
**04-0900**  
175 mm



**BABY-METZENBAUM  
SCISSORS TC Carbide**  
145 mm

SOFT TECH Surgical, Manufacturer & Exporter of Quality Instruments

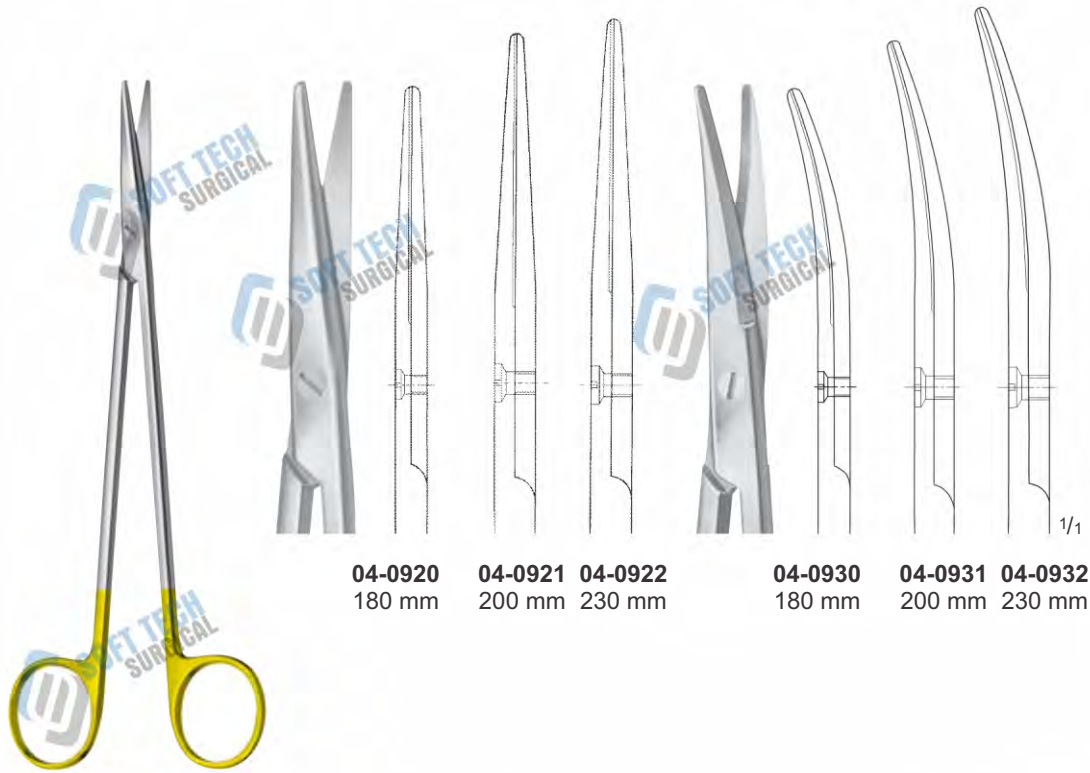

**04-0920** 180 mm    **04-0921** 200 mm    **04-0922** 230 mm    **04-0930** 180 mm    **04-0931** 200 mm    **04-0932** 230 mm

**METZENBAUM SCISSORS**  
TC Carbide



**04-0940** 260 mm    **04-0941** 280 mm    **04-0942** 285 mm

**NELSON-METZENBAUM SCISSORS**  
TC Carbide

**NELSON-METZENBAUM SCISSORS**  
TC Carbide  
**04-0945**  
350 mm

SOFT TECH Surgical, Manufacturer & Exporter of Quality Instruments



**04-0950** **04-0951**  
145 mm 180 mm

**04-0955** **04-0956** **04-0957**  
145 mm 180 mm 200 mm

**METZENBAUM SCISSORS**  
TC Carbide



**04-0960**  
200 mm

**04-0965** **04-0966**  
230 mm 300 mm

**NELSON-METZENBAUM (MCINDOE)  
SCISSORS TC Carbide**

**METZENBAUM SCISSORS**  
TC Carbide  
**04-0970**  
230 mm



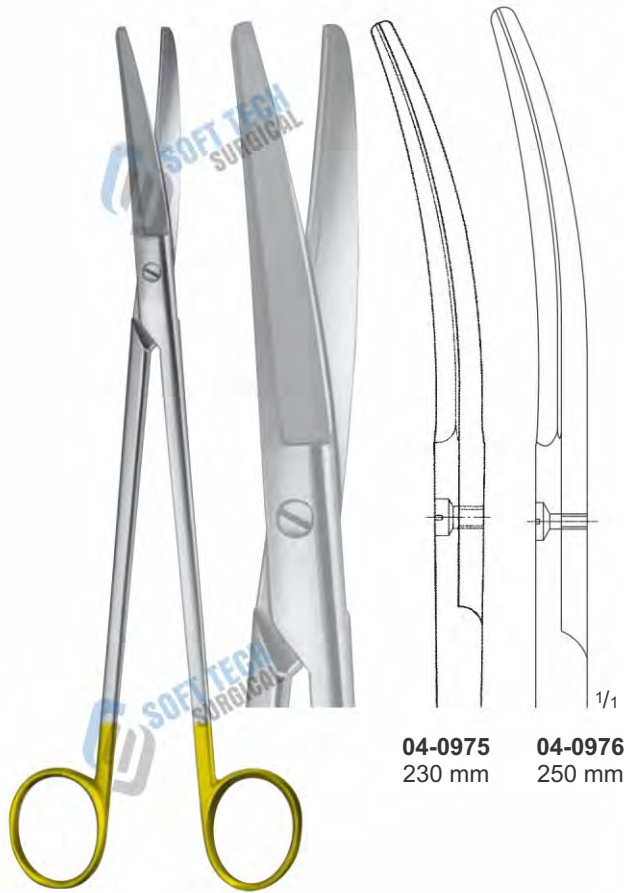

**04-0975** 230 mm  
**04-0976** 250 mm

**WERTHEIM SCISSORS**  
TC Carbide



**04-0980** 200 mm  
**04-0981** 230 mm  
**04-0982** 250 mm

**SIMS UTERINE SCISSORS**  
TC Carbide



1 blade serrated

**UNIVERSAL WIRE CUT**  
**SCISSORS TC Carbide**  
**04-0985**  
120 mm

SOFT TECH Surgical, Manufacturer & Exporter of Quality Instruments



**04-0990**  
255 mm

**HYSTERECTOMY SCISSORS**  
STRONGLY CURVED TC Carbide



**04-0995**  
250 mm

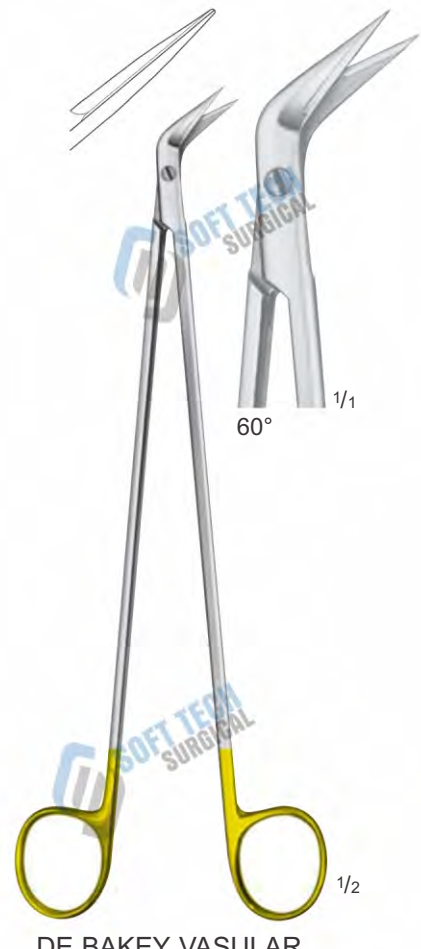

**DE BAKKEY VASULAR  
SCISSORS TC Carbide**

**04-1000**  
220 mm

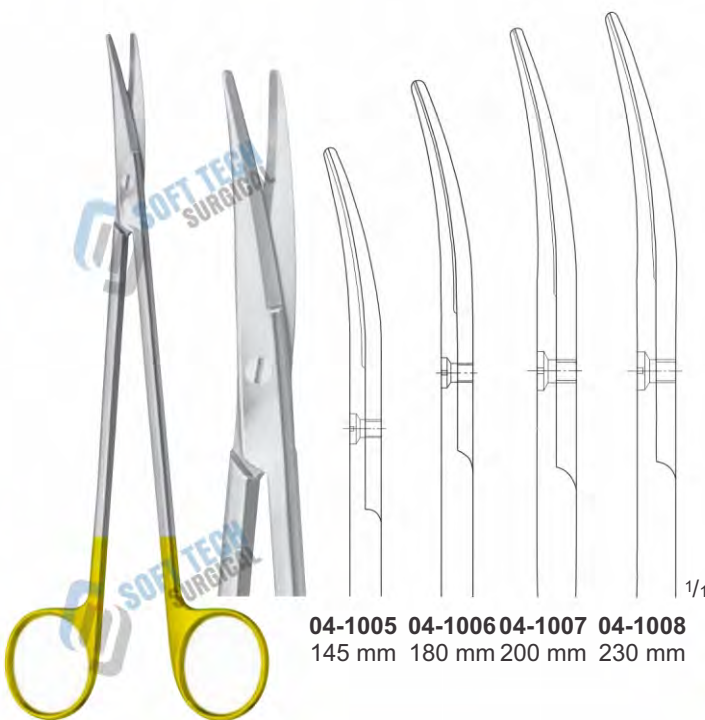

**04-1005 04-1006 04-1007 04-1008**  
145 mm 180 mm 200 mm 230 mm

**METZENBAUM SCISSOR**

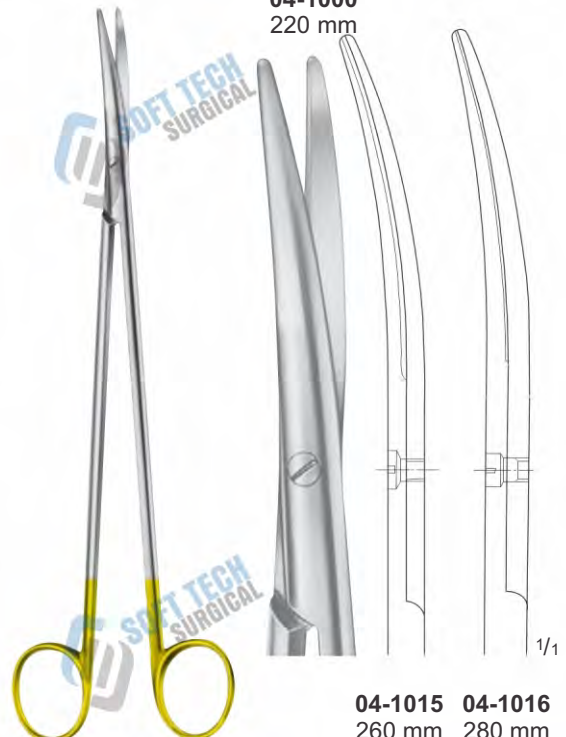

**04-1015 04-1016**  
260 mm 280 mm

**NELSON-METZENBAUM**

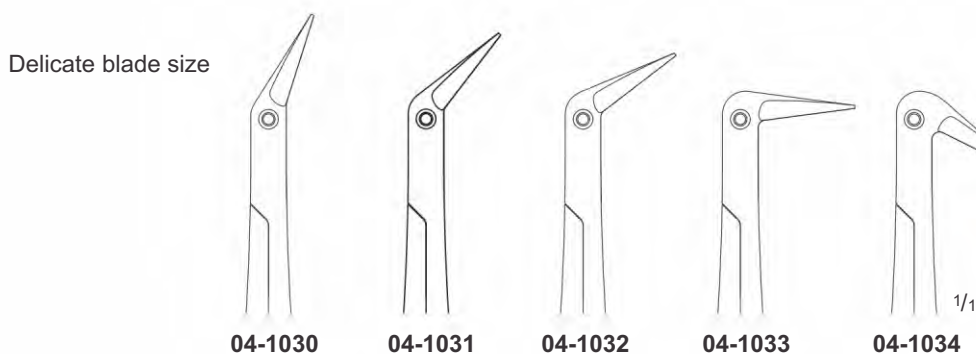
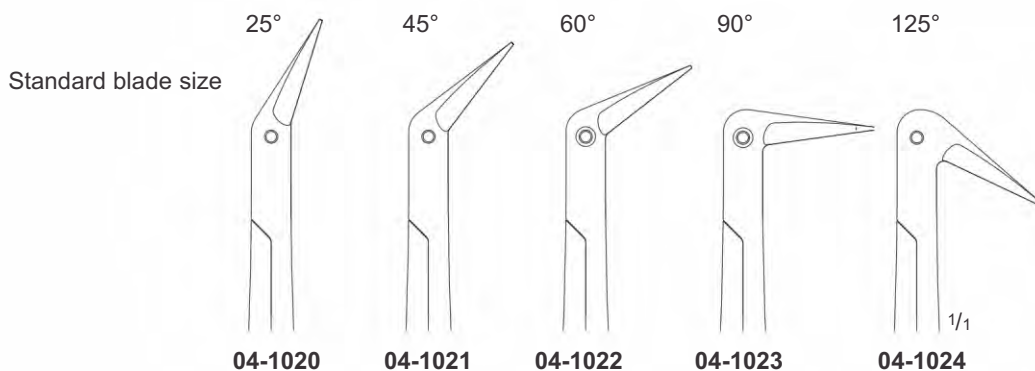

DIETHRICH POTTS  
SCISSOR  
180 mm



SOFT TECH Surgical, Manufacturer & Exporter of Quality Instruments

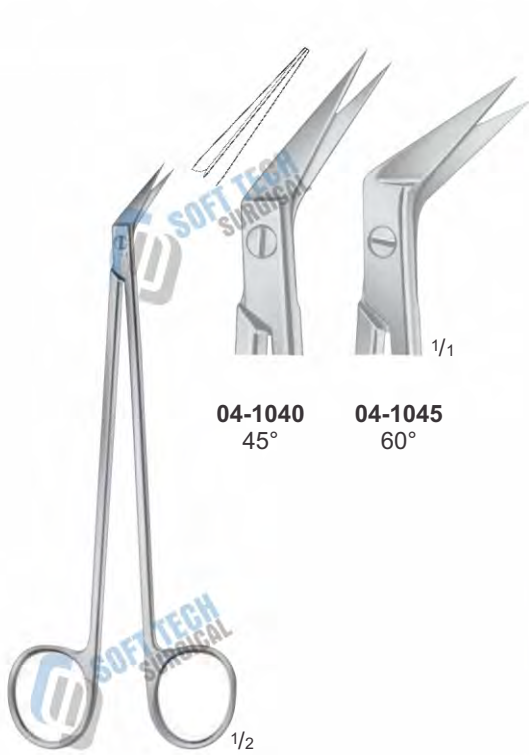

**DE BAKEY SCISSORS**  
155 mm

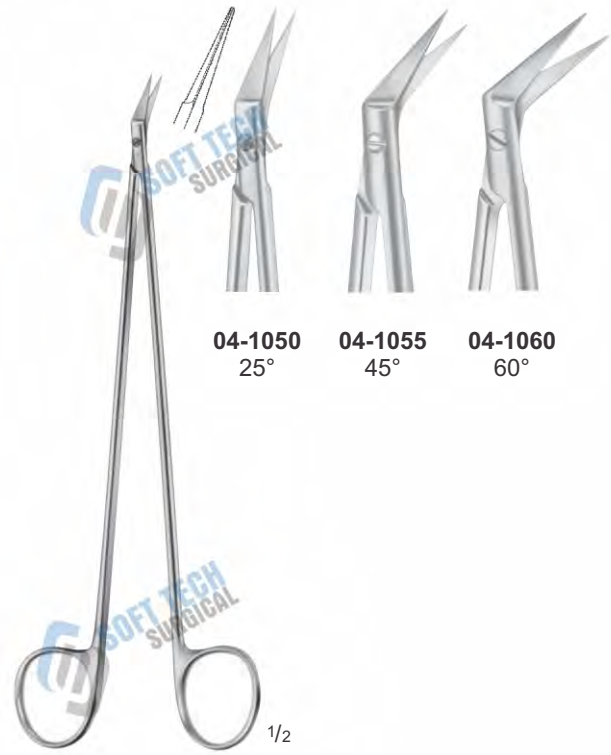

**DIETHRICH-HEGEMANN  
SCISSORS**  
180 mm



**POTTS-DE MARTE  
SCISSORS**  
185 mm



**DIETHRICH SCISSORS**  
170 mm

SOFT TECH Surgical, Manufacturer & Exporter of Quality Instruments



**POTTS-SMITH**  
**04-1090**  
Cardiovascular scissors  
180 mm

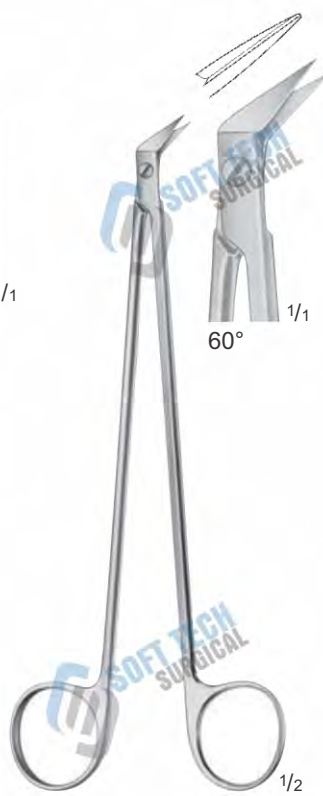

**POTTS-SMITH**  
**04-1095**  
Cardiovascular scissors  
180 mm



**POTTS-DE  
MARTEL**  
**04-1100**  
60°

Cardiovascular scissors  
220 mm

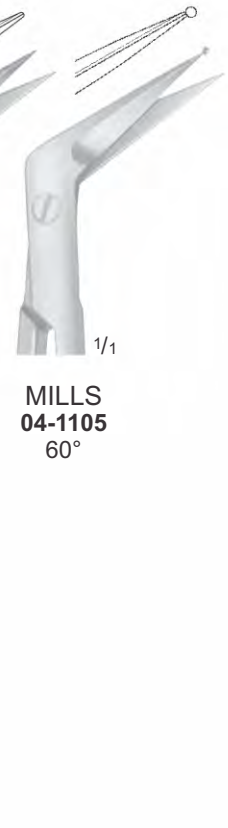

**MILLS**  
**04-1105**  
60°

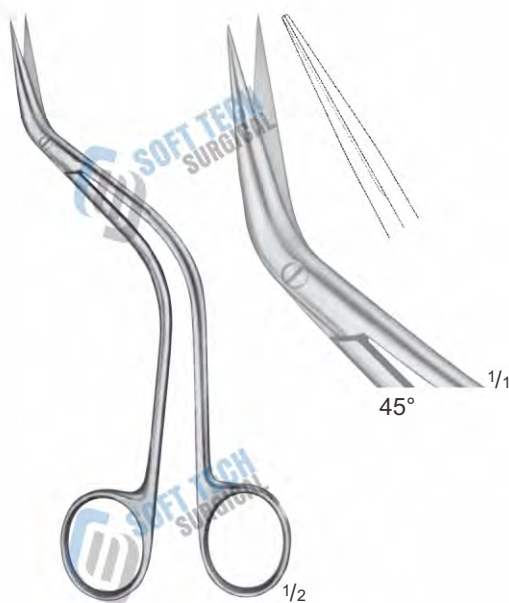

**DE BAKY**  
**OFFSET-SCISSORS S-SHAPED**  
**04-1110**  
155 mm

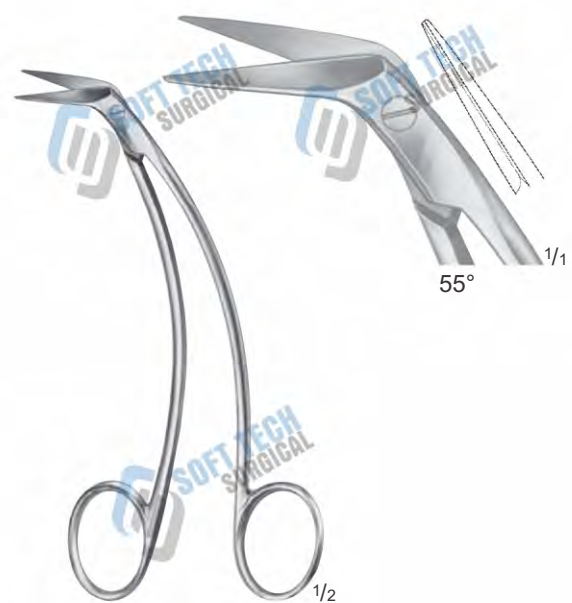

**FAVOLORO VASCULAR**  
**SCISSORS CURVED TO LEFT**  
**04-1115**  
140 mm

SOFT TECH Surgical, Manufacturer & Exporter of Quality Instruments



SCHMIEDEN-TAYLOR DURA  
04-1120  
155 mm

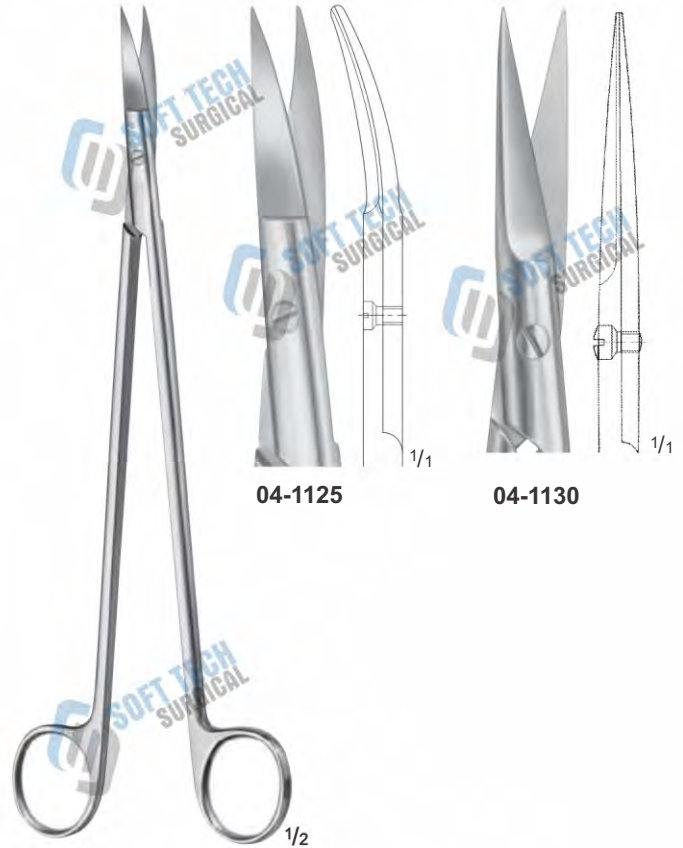

STRULLY VASCULAR SCISSORS SHARP  
220 mm

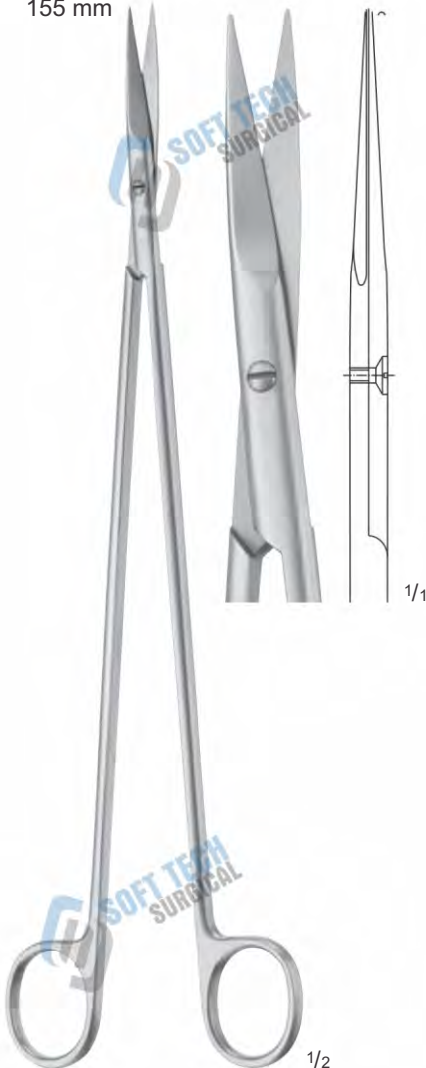

BARRÉ SCISSORS SHARP / SHARP  
04-1135  
280 mm



STRULLY VASCULAR SCISSORS  
PROBE POINTED  
04-1140  
220 mm



SOFT TECH Surgical, Manufacturer & Exporter of Quality Instruments

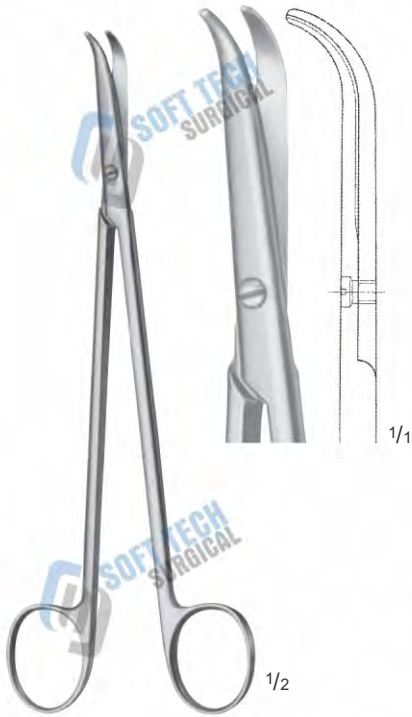

**THOREK SCISSORS S**  
**STRONGLY CURVED**  
**04-1145**  
180 mm



**POTTS- SMITH SCISSORS CURVE**  
**04-1150**  
190 mm



**COOLEY SCISSORS CURVED**  
**BLUNT / BLUNT,**  
**04-1155**  
190 mm

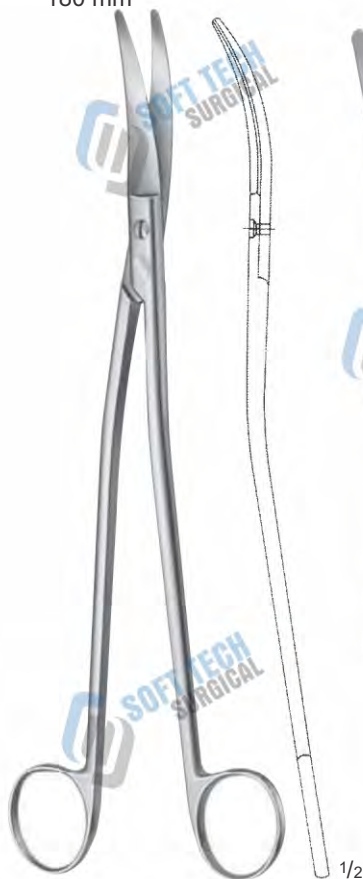

**KLINGENBERG-LOTH**  
**SCISSORS**  
**04-1160**  
230 mm

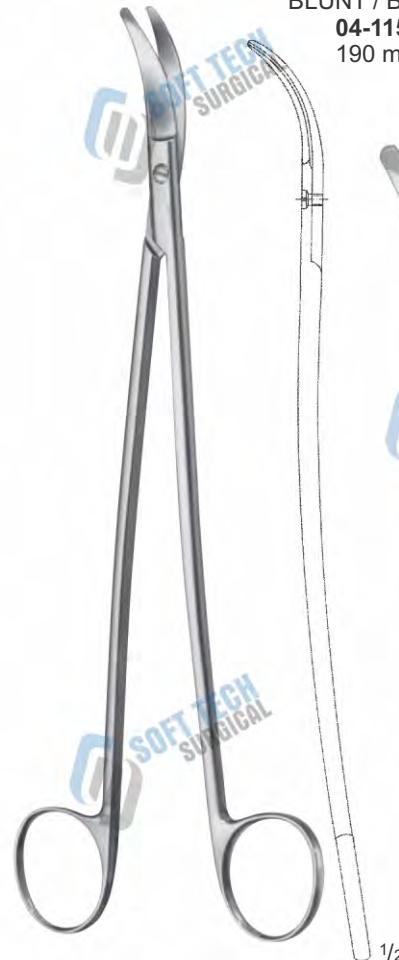

**SATINSKY SCISSORS**  
**04-1165**  
245 mm



SOFT TECH Surgical, Manufacturer & Exporter of Quality Instruments

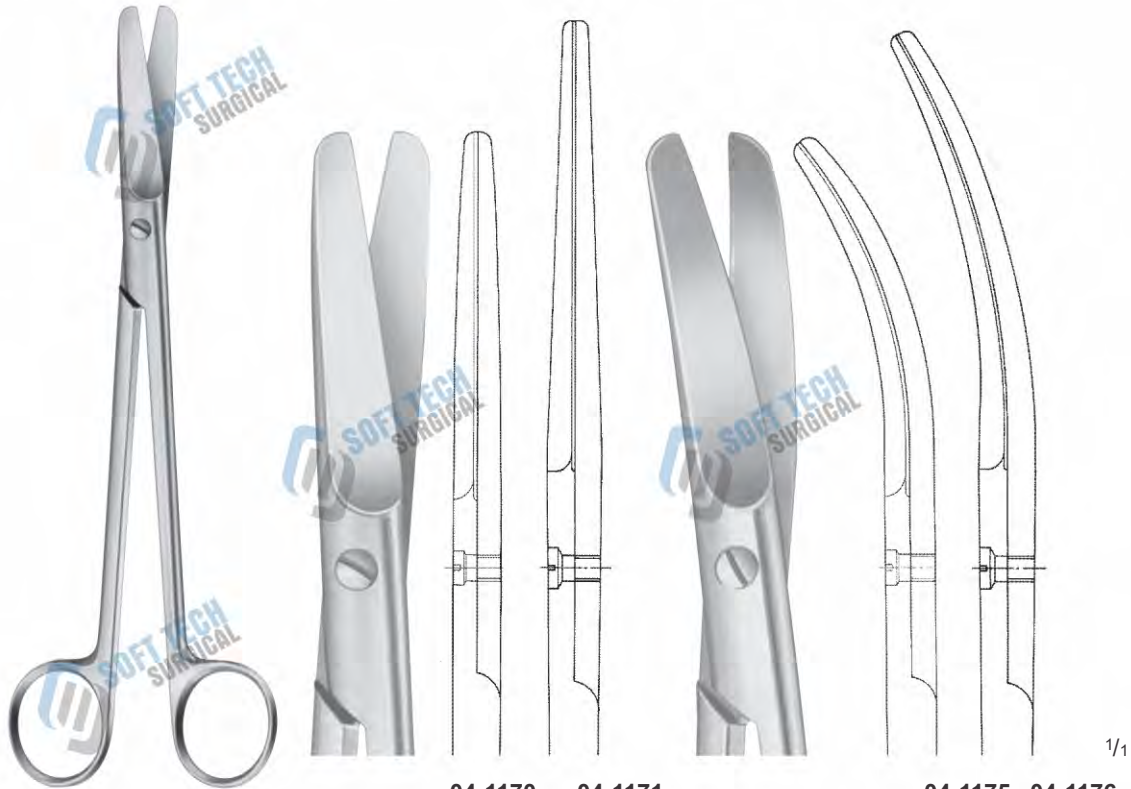

SIMS UTERINE SCISSORS

**04-1170** 200 mm  
**04-1171** 230 mm

**04-1175** 200 mm  
**04-1176** 230 mm

1/1



SIMS UTERINE SCISSORS  
CURVED SHARP / BLUNT

**04-1180** 200 mm  
**04-1181** 230 mm

1/1



**SIMS UTERINE SCISSORS**  
 STRAIGHT SHARP / SHARP  
**04-1185**  
 200 mm



**WERTHEIM DISSECTING**  
 SCISSORS CURVED

**04-1190** 145 mm   **04-1191** 200 mm   **04-1192** 230 mm



SOFT TECH Surgical, Manufacturer & Exporter of Quality Instruments



**SIEBOLD UTERINE  
SCISSORS S-SHAPED**  
**04-1195**  
245 mm



**BOZEMANN UTERINE  
SCISSORS CURVED**  
**04-1200**  
220 mm



**KIEBACK PARAMETRIUM SCISSORS**  
CURVED PROBE POINTED

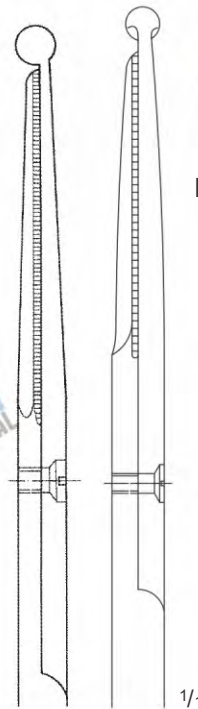

**04-1205**  
260 mm

**04-1206**  
250 mm



SCHUMACHER UMBILICAL  
CORD SCISSORS  
**04-1210**  
155 mm



UMBILICAL CORD SCISSORS  
**04-1215**  
105 mm



**04-1220**  
135 mm



**04-1221**  
160 mm



UMBILICAL CORD SCISSORS  
CURVED SIDWARDS

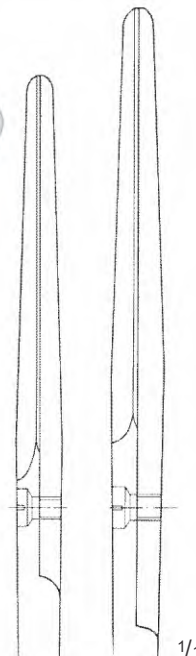

**1/1**

**04-1221**  
160 mm

SOFT TECH Surgical, Manufacturer & Exporter of Quality Instruments



**BRAUN- STADLER  
EPISIOTOMY  
SCISSORS**



**04-1225**  
145 mm

**04-1226**  
200 mm



**EPISIOTOMY SCISSORS**  
**04-1230**  
240 mm



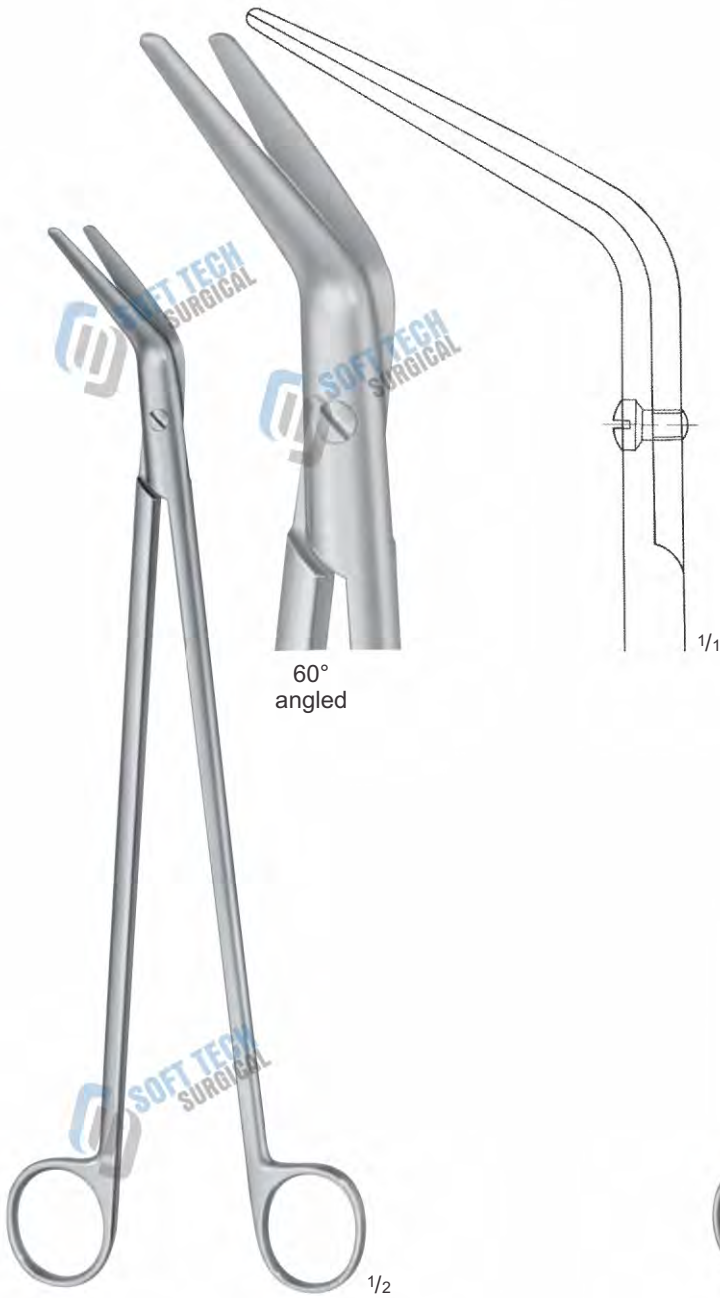

DISSECTING SCISSORS  
CUTTING OF THE BOWEL  
04-1235  
280 mm

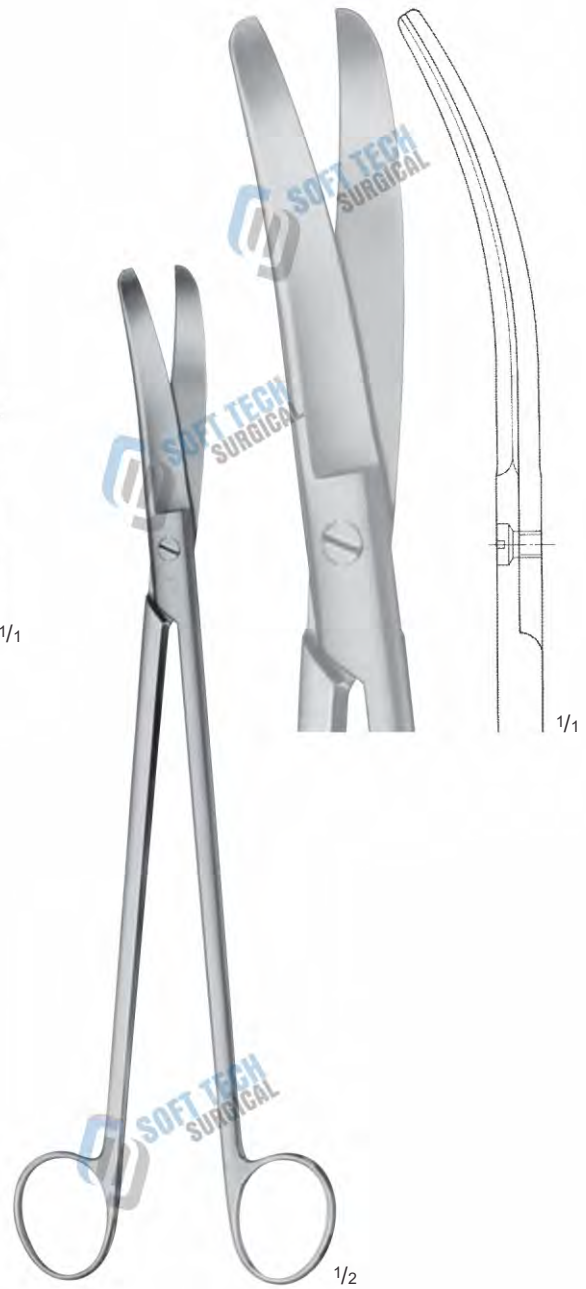

LLOYD-DAVIES (GOLIGHER'S)  
RECTAL SCISSORS  
04-1240  
270 mm

SOFT TECH Surgical, Manufacturer & Exporter of Quality Instruments

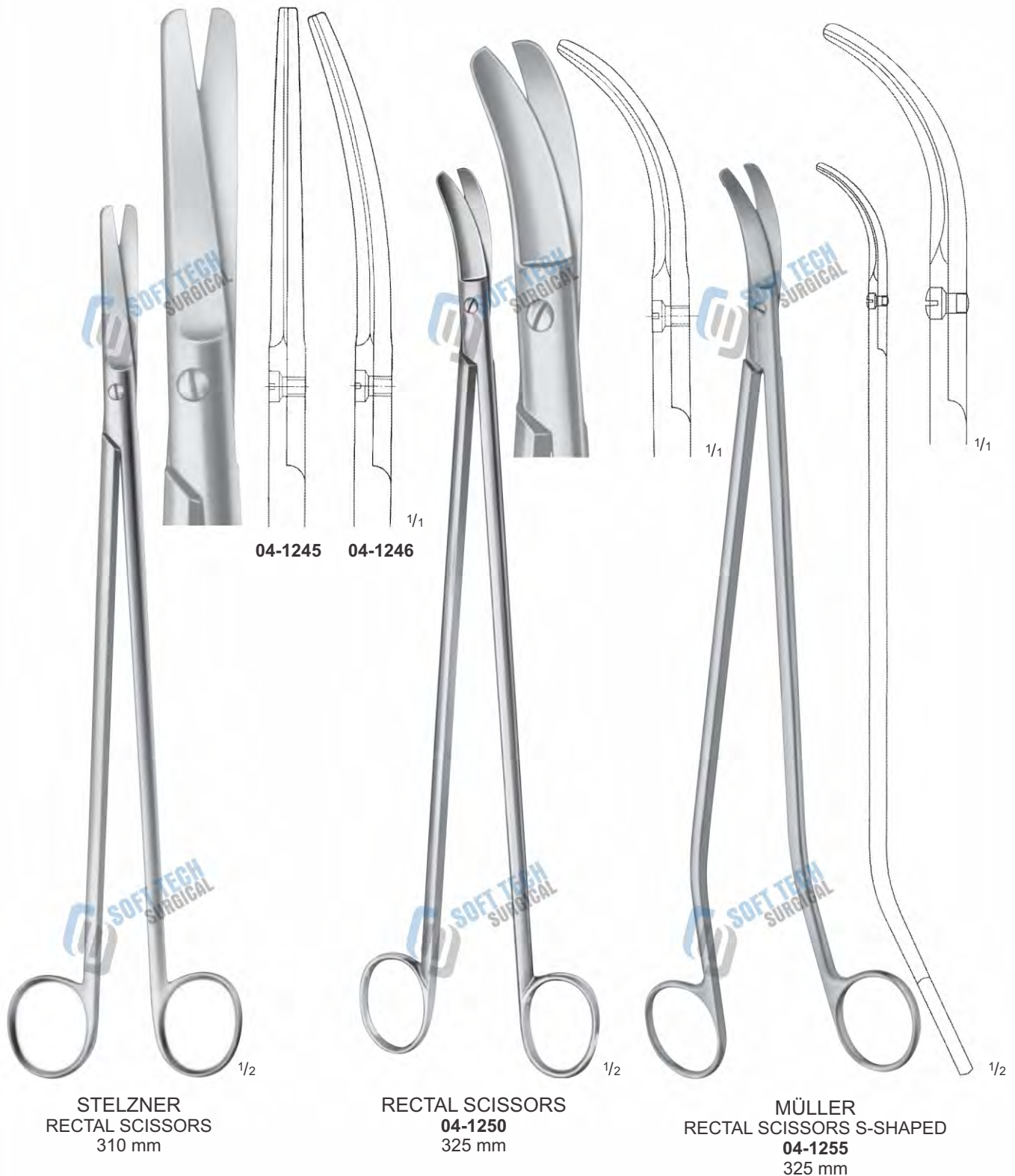



SPENCER LIGATURE SCISSORS



LITTAUER LIGATURE SCISSORS

04-1265  
135 mm



NORTHBENT LIGATURE SCISSORS

04-1270  
120 mm



SOFT TECH Surgical, Manufacturer & Exporter of Quality Instruments



**BEEBE  
WIRE CUTTING SCISSORS**  
110 mm

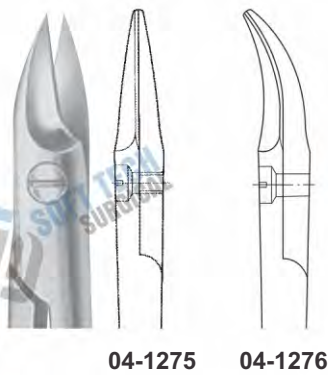

**04-1275**

**04-1276**



**04-1280**  
broad blades

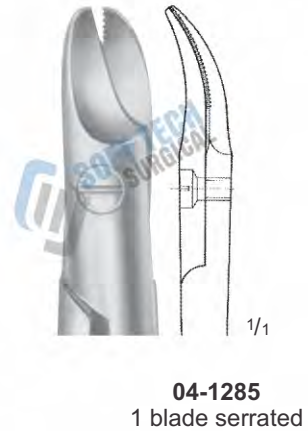

**04-1285**  
1 blade serrated

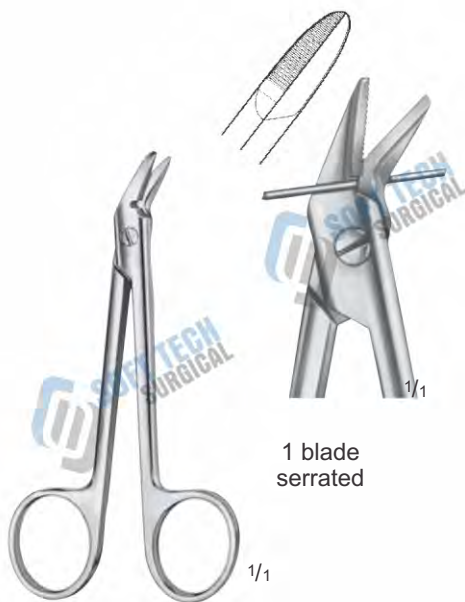

**UNIVERSAL  
WIRE CUT SCISSORS**  
**04-1290**  
120 mm



**HARVEY  
SCISSORS**  
**04-1295**  
125 mm



**NAIL SCISSORS**  
**04-1300**  
90 mm



**NAIL SCISSORS**  
**DELICATE PATTERN**  
**04-1305**  
90 mm



**BABY NAIL SCISSORS**  
**04-1310**  
85 mm



**NAIL SCISSORS**

**04-1315** 90 mm  
**04-1316** 90 mm  
**04-1317** 100 mm  
**04-1318** 110 mm



**NAIL SCISSORS**

**04-1320** 95 mm  
**04-1321** 95 mm  
**04-1322** 105 mm

SOFT TECH Surgical, Manufacturer & Exporter of Quality Instruments



**LISTER BANDAGE  
SCISSORS UNIVERSAL**

toothed edges  
145 mm

- 04-1325** black
- 04-1326** red
- 04-1327** blue



**BANDAGE SCISSORS  
UNIVERSAL SCISSORS**

Toothed edges  
180 mm

- 04-1330** black
- 04-1331** red
- 04-1335** blue



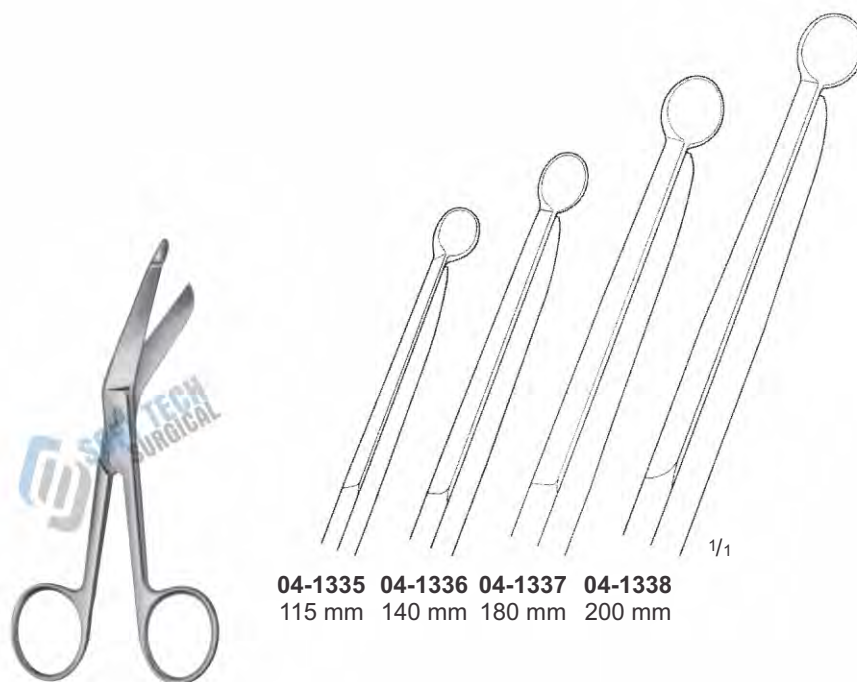

**04-1335 04-1336 04-1337 04-1338**  
115 mm 140 mm 180 mm 200 mm

**LISTER BANDAGE SCISSORS**



**PLASTER SHEAR**  
**04-1340**  
160 mm

SOFT TECH Surgical, Manufacturer & Exporter of Quality Instruments

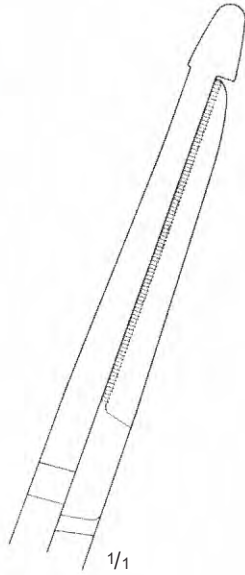

PLASTER BANDAGE  
SCISSORS  
with wire cutter  
**04-1345**  
205 mm

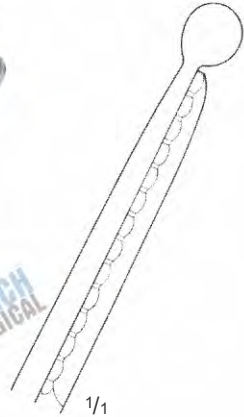

PLASTER SHEARS  
**04-1350**  
160 mm

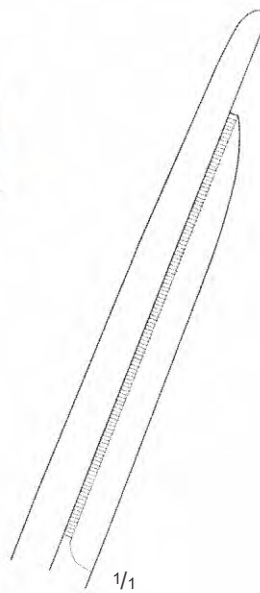

SEUTIN PLASTER SCISSORS  
**04-1355**  
230 mm

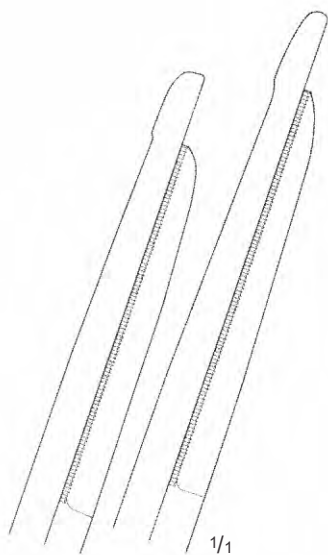

04-1360 04-1361

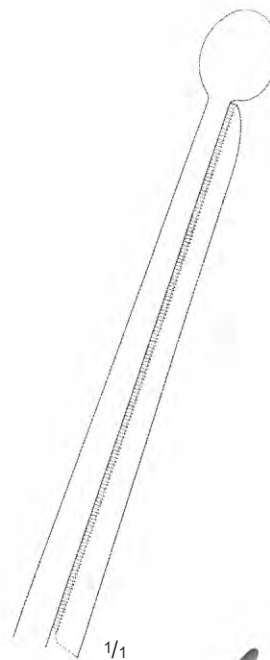

1/1



ESMARCH  
200 mm  
PLASTER SCISSORS



BERGMANN  
04-1365  
230 mm  
PLASTER SCISSORS



SOFT TECH Surgical, Manufacturer & Exporter of Quality Instruments

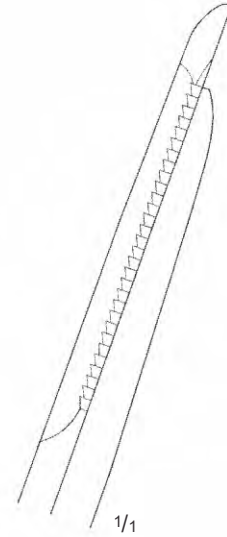
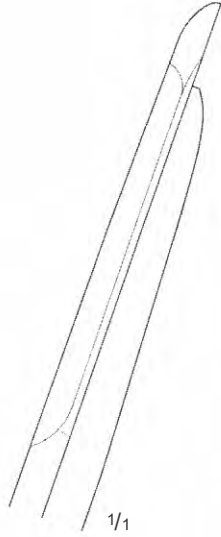

**BRUNS PLASTER**  
**SHEAR**  
**04-1370**  
235 mm

**GUYS (BOHLER)**  
**PLASTER SHEAR**  
**04-1375**  
235 mm



**SOFT TECH  
SURGICAL**

## **General Surgery Instruments Catalogue**

### **SOFT TECH Surgical**

Muslim Town, Airport Road  
Kotli Behram, Sialkot 51310  
Pakistan.

Email : [info@softtechsurgical.com](mailto:info@softtechsurgical.com)  
Website : [www.softtechsurgical.com](http://www.softtechsurgical.com)

Phone : +92 52 3573488  
+92 52 3242929  
+92 52 4264934  
Fax : +92 52 3242929

 +92 336 4770459