



**SOFT TECH  
SURGICAL**

**26**

**Bone Holding  
Forceps  
&  
Bone Rongeurs**





REPOSITION  
FORCEPS  
**26-0100**  
stepped tips  
95 mm



REPOSITION FORCEPS,  
FOR SMALL FRAGMENTS  
**26-0105**  
135 mm



REPOSITION FORCEPS  
**26-0110**  
135 mm



HAASE, REPOSITION  
FORCEPS  
**26-0115**  
165 mm



**WÖRRLEIN REPOSITION  
TAMPER**  
**26-0120**  
165 mm



**REILL REPOSITION FORCEPS  
CURVED TO SIDE**  
**26-0125**  
170 mm



**REPOSITION FORCEPS**  
**26-0130**  
205 mm

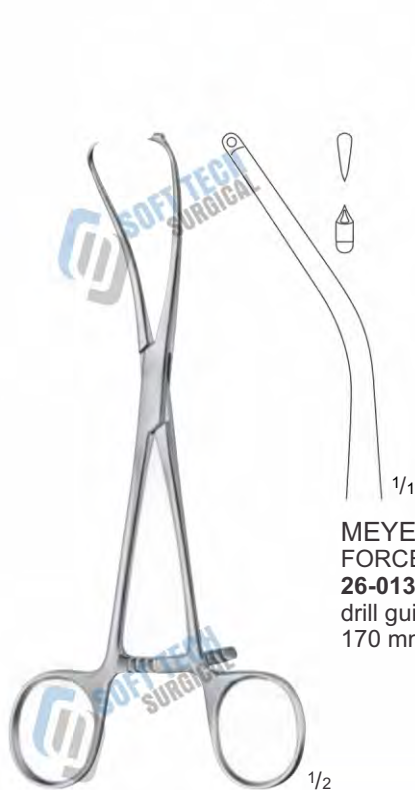

**MEYER REPOSITION  
FORCEPS**  
**26-0135**  
drill guide diam. 1 mm  
170 mm



**MEYER, REPOSITION  
FORCEPS**  
**26-0140**  
drill guide diam. 2 mm  
205 mm

SOFT TECH Surgical, Manufacturer & Exporter of Quality Instruments



**PATELLA FORCEPS**  
**26-0145**  
185 mm



**BONE HOLDING  
FORCEPS**  
**26-0150**  
210 mm



**REPOSITION FORCEPS,  
WITH RATCHET**  
**26-0155**  
140 mm



**REPOSITION FORCEPS,  
WITH THREAD  
FIXATION**  
**26-0160**  
170 mm



**REPOSITION FORCEPS,  
WITH THREAD  
FIXATION**  
**26-0165**  
235 mm





SEQUESTRUM FORCEPS  
26-0170  
185 mm



DINGMAN BONE HOLDING FORCEPS  
26-0175  
185 mm



DINGMAN BONE  
HOLDING FORCEPS  
26-0180  
200 mm

SOFT TECH Surgical, Manufacturer & Exporter of Quality Instruments



**BONE HOLDING FORCEPS**  
**26-0185**  
200 mm



**LANGENBECK BONE  
HOLDING FORCEPS**  
**26-0190**  
205 mm



**FERGUSSON, BONE  
HOLDING FORCEPS**  
**26-0195**  
205 mm



**SEMB BONE  
HOLDING FORCEPS**  
**26-0200**  
190 mm



**SEMB BONE  
HOLDING FORCEPS**  
**26-0205**  
190 mm



FARABEU F BONE  
HOLDING FORCEPS  
**26-0210**  
230 mm



FARABEU F BONE  
HOLDING FORCEPS  
**26-0215**  
255 mm



FARABEU-F LAMBOTTE, BONE  
HOLDING FORCEP  
**26-0220**  
255 mm



**KERN-LANE BONE HOLDING  
FORCEPS**  
**26-0225**  
240 mm



**LANE BONE HOLDING FORCEPS**  
**26-0230**  
330 mm





KERN-MINI BONE HOLDING  
FORCEPS  
26-0235  
155 mm



LANE BONE HOLDING FORCEPS  
26-0245  
320 mm



KERN-LANE BONE HOLDING FORCEPS  
26-0240  
240 mm



HEY GROVES BONE  
HOLDING FORCEPS  
**26-0250**  
210 mm

HEY GROVES BONE  
HOLDING FORCEPS  
**26-0255**  
270 mm

HEY GROVES BONE  
HOLDING FORCEPS  
**26-0260**  
305 mm

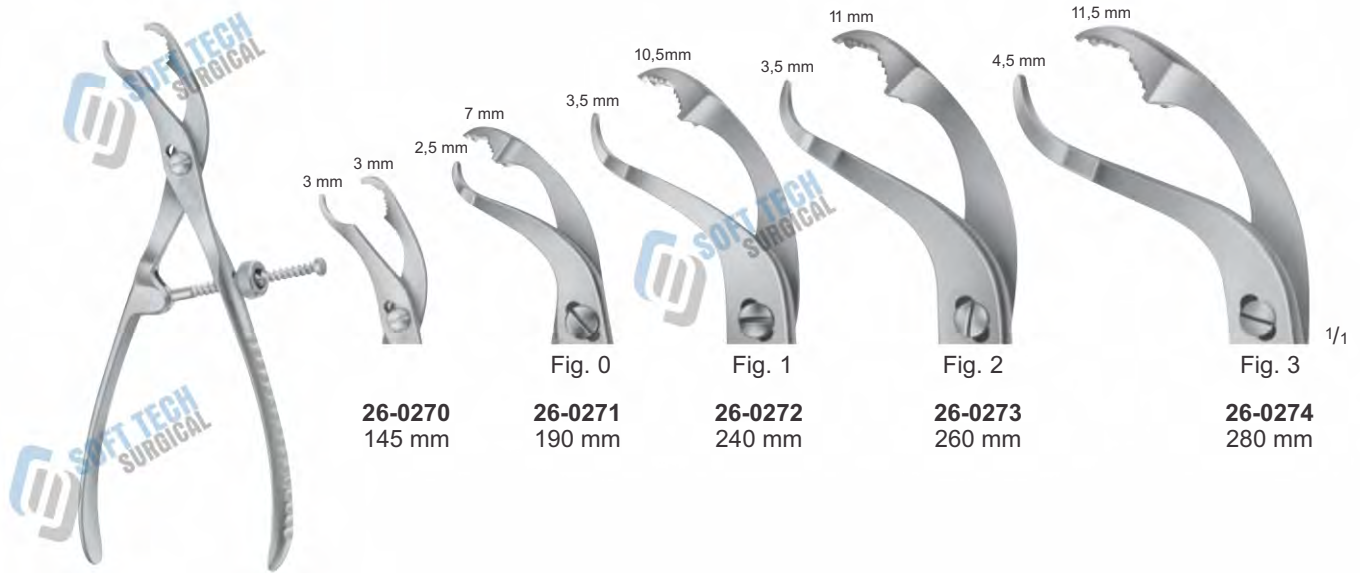

BONE HOLDING  
FORCEPS  
self-centering

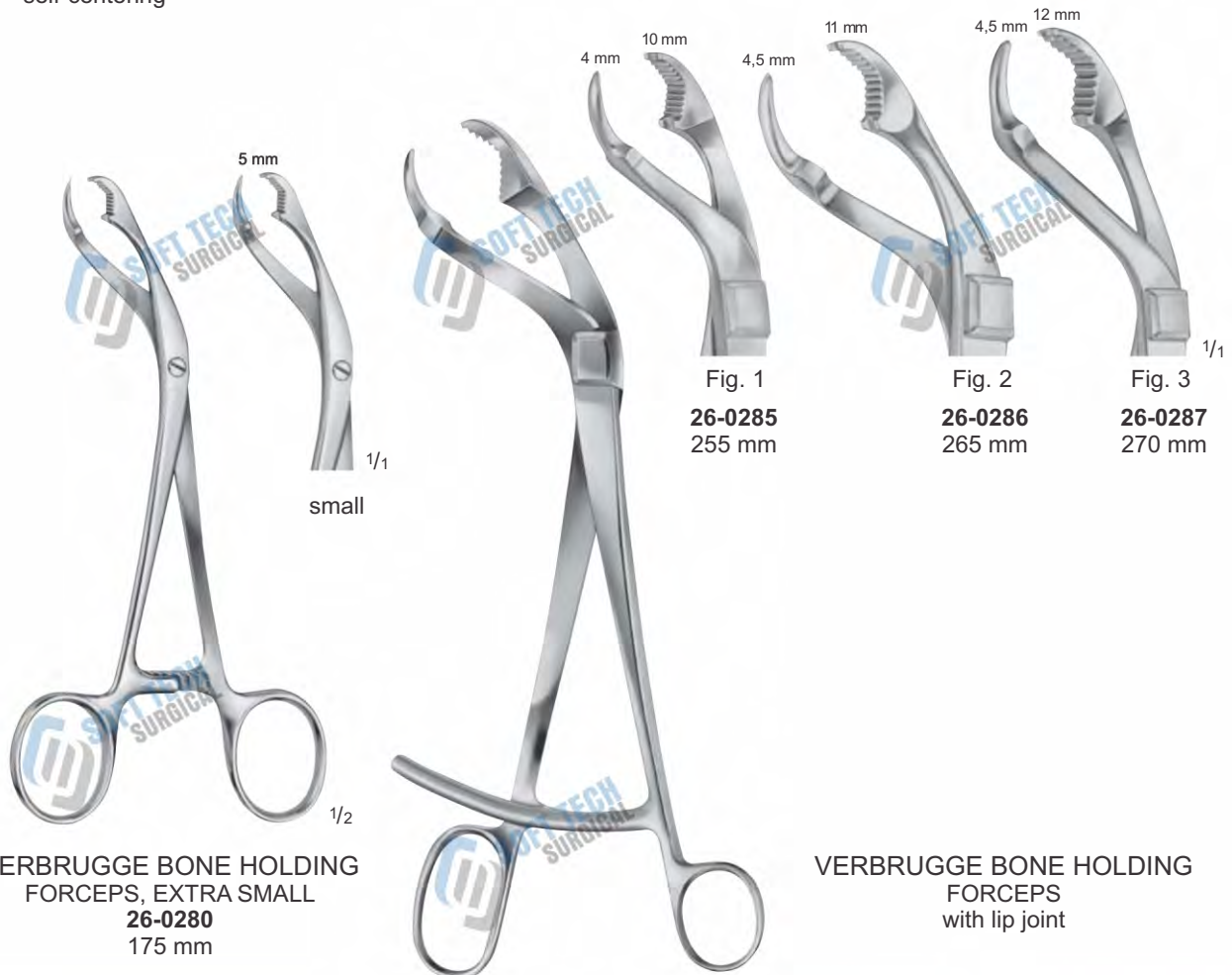

VERBRUGGE BONE HOLDING  
FORCEPS, EXTRA SMALL  
26-0280  
175 mm

VERBRUGGE BONE HOLDING  
FORCEPS  
with lip joint

SOFT TECH Surgical, Manufacturer & Exporter of Quality Instruments



LOWMAN BONE CLAMP

26-0290 170 mm  
26-0291 205 mm



LOWMAN- GERSTER,  
BONE CLAMP  
26-0295  
210 mm



LEWIN BONE CLAMP SERRATED

26-0300  
185 mm



LOWMAN- HOGLUND BONE CLAMP

26-0305  
175 mm





STELLBRINK,  
SYNOVECTOMY  
RONGEUR  
**26-0310**  
175 mm



STELLBRINK,  
SYNOVECTOMY  
RONGEUR  
**26-0315**  
170 mm



SCHWARZ BONE  
RONGEUR  
**26-0320**  
145 mm



FRIEDMANN BONE  
RONGEUR  
140 mm

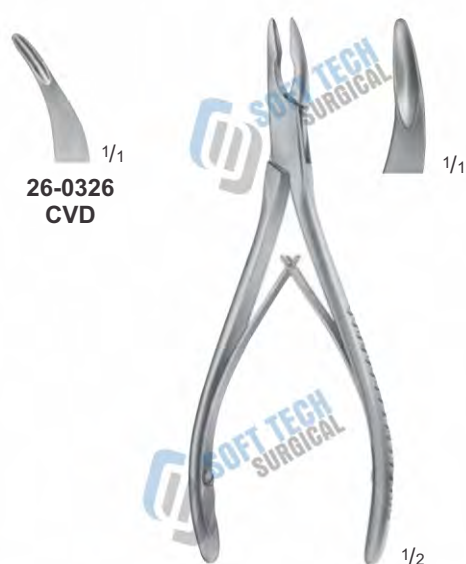

LUER- FRIEDMANN,  
BONE RONGEUR  
**26-0330**  
145 mm



**BONE RONGEUR,  
45° CURVED  
26-0340  
150 mm**



**BONE RONGEUR  
26-0345  
140 mm**



**LUER BONE RONGEUR  
26-0350  
150 mm**



**LUER BONE RONGEUR**  
**26-0355**  
155 mm



**BLUMENTHAL BONE RONGEUR**  
**26-0360**  
155 mm



**BLUMENTHAL BONE RONGEUR**  
**26-0365**  
150 mm



**HAKANSSON BONE RONGEUR**  
**26-0370**  
170 mm



**JANSEN BONE RONGEUR**  
175 mm



**26-0375**  
**STR**

**26-0376**  
**CVD**



**BANE- HARTMANN BONE RONGEUR**  
**26-0380**  
175 mm



SOFT TECH Surgical, Manufacturer & Exporter of Quality Instruments



**ALEXANDER  
BONE RONGEUR  
26-0385  
140 mm**



**JANSEN BONE RONGEUR,  
BYONETT SHAPE  
26-0390  
190 mm**

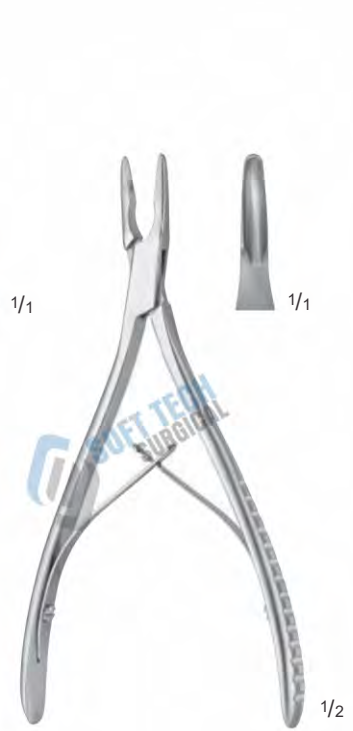

**BONE RONGEUR  
26-0395  
165 mm**



**LEMPERT BONE RONGEUR  
200 mm**

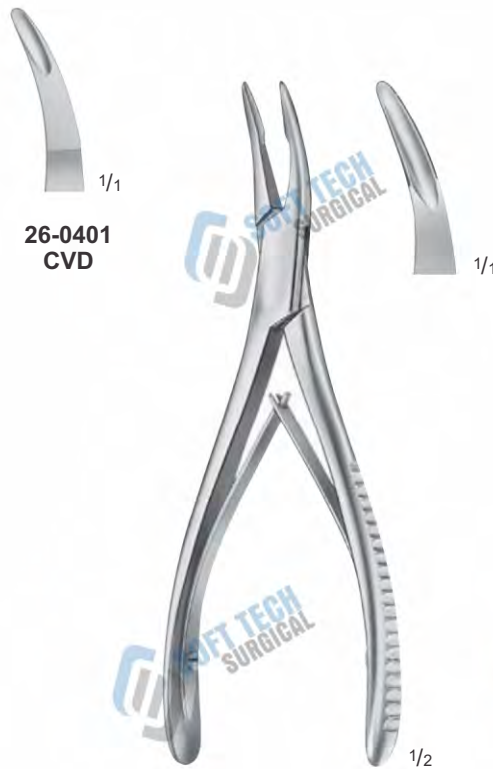

**BEYER BONE RONGEUR  
26-0405  
180 mm**



**MEAD BONE RONGEUR  
26-0410  
165 mm**



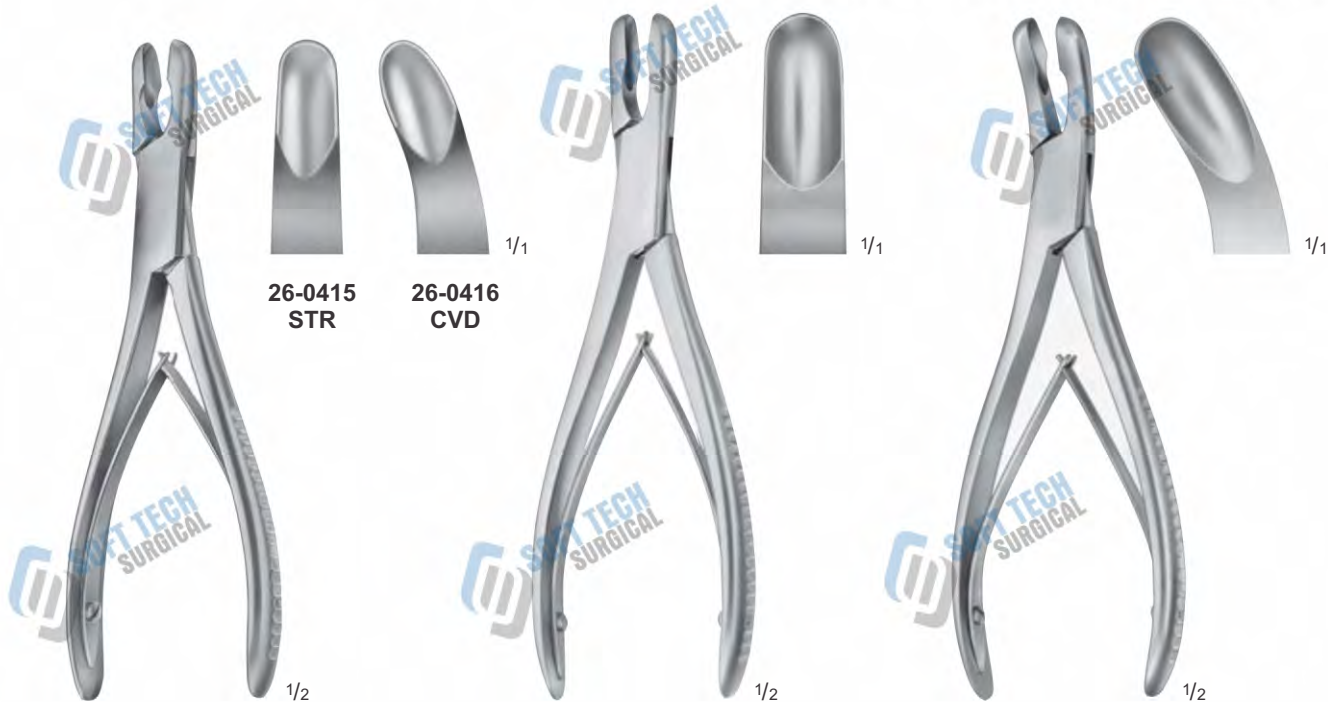

LUER BONE RONGEUR  
175 mm

26-0415  
STR

LUER BONE RONGEUR  
26-0420  
180 mm

26-0416  
CVD

LUER, BONE RONGEUR  
26-0425  
180 mm



OLIVECRONA BONE  
RONGEUR  
26-0430  
205 mm

GULEKE BONE  
RONGEUR  
26-0435  
205 mm

TROTTER, BONE RONGEUR  
26-0440  
205 mm

curved  
to side

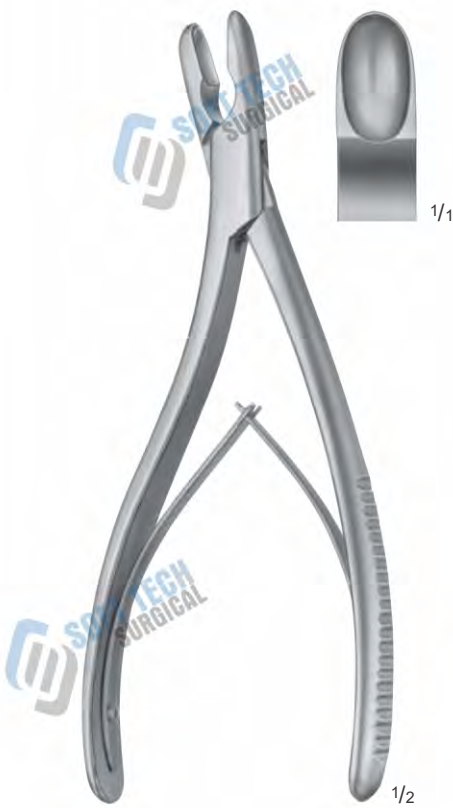

**NORTHFIELD BONE  
RONGEUR**  
**26-0445**  
210 mm



**PENNYBACKER BONE  
RONGEUR**  
**26-0450**  
205 mm

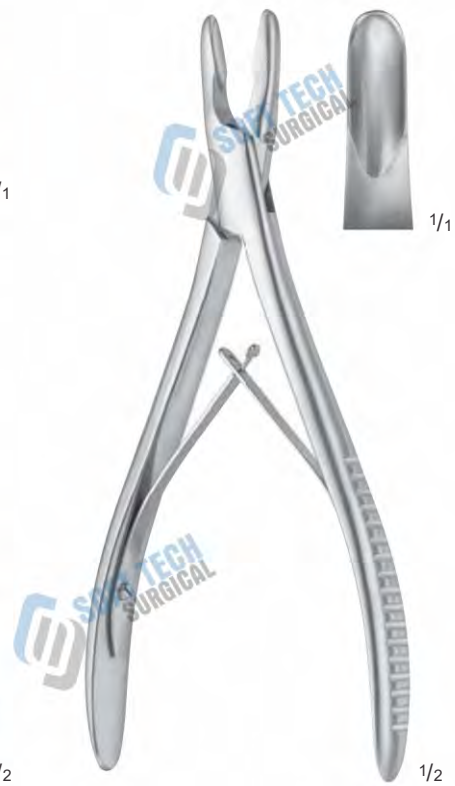

**ADSON BONE RONGEUR**  
**26-0455**  
200 mm

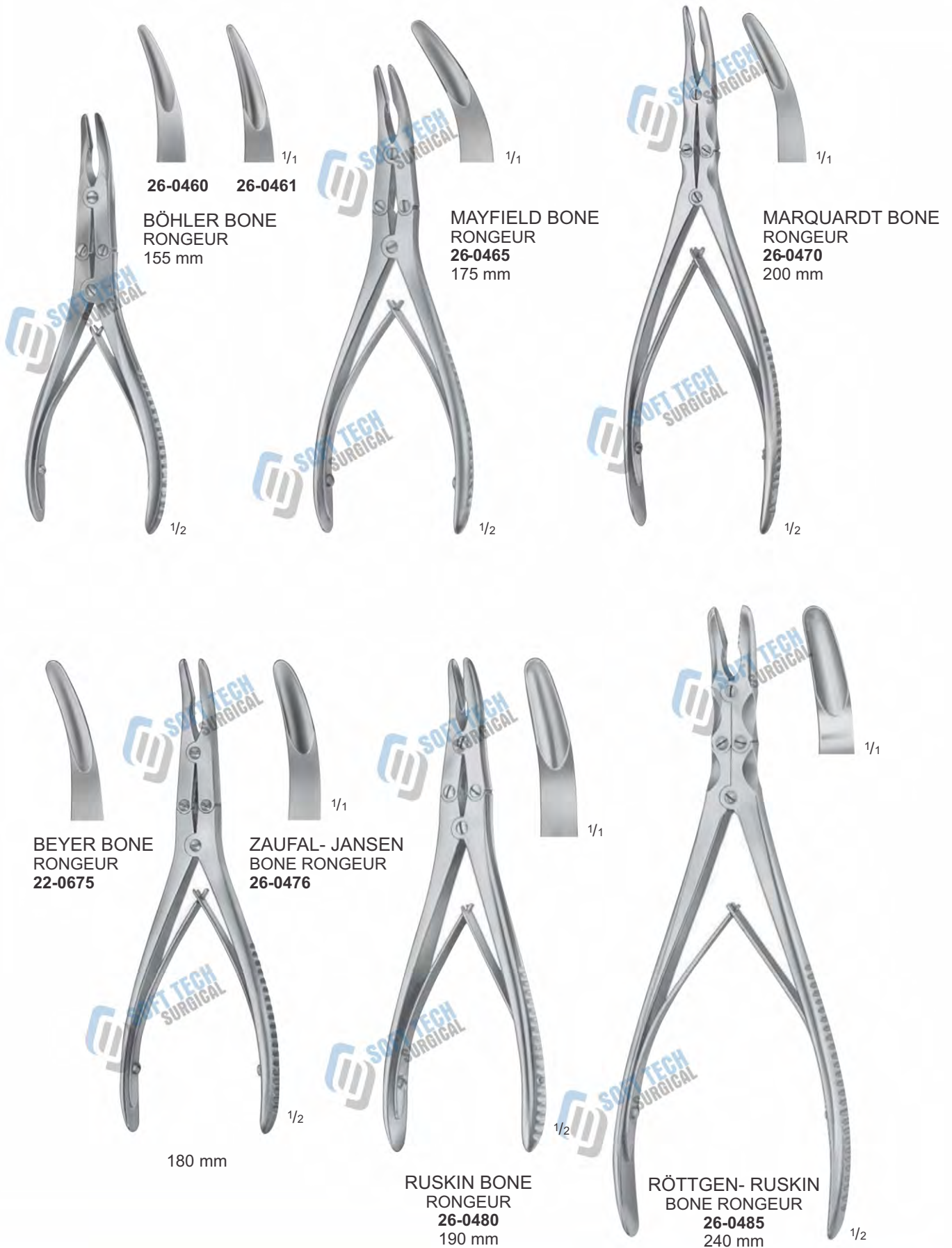



SOFT TECH Surgical, Manufacturer & Exporter of Quality Instruments

5X16 mm 3X16 mm



**26-0490 26-0491**



**LEKSELL RONGEUR  
MOUTH  
245 mm**



**26-0495 26-0496**



**ECHLIN BONE RONGEUR  
230 mm**



**FRYKHOLM BONE RONGEUR  
26-0500  
240 mm**





**STILLE BONE RONGEUR**  
**26-0505**  
235 mm



**LEKSELL- STILLE BONE RONGEUR**  
**26-0510**  
240 mm



**STILLE- RUSKIN BONE RONGEUR**  
**26-0515**  
240 mm

SOFT TECH Surgical, Manufacturer & Exporter of Quality Instruments

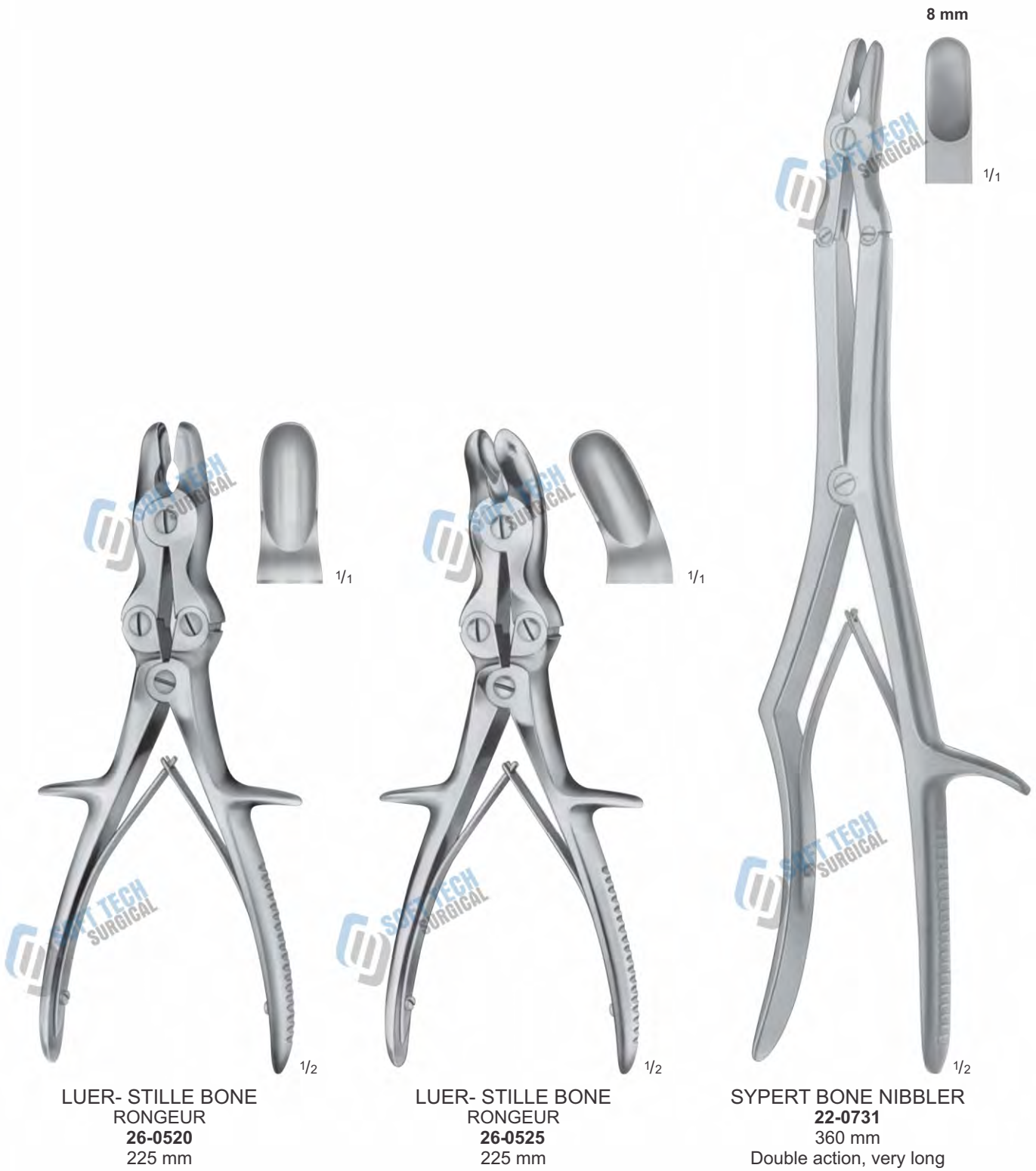



LUER- STILLE  
BONE RONGEUR  
26-0535  
270 mm



SEMB  
BONE RONGEUR  
21-1515  
240 mm



SAUERBRUCH- CORYLLOS  
BONE RONGEUR  
310 mm



SOFT TECH Surgical, Manufacturer & Exporter of Quality Instruments

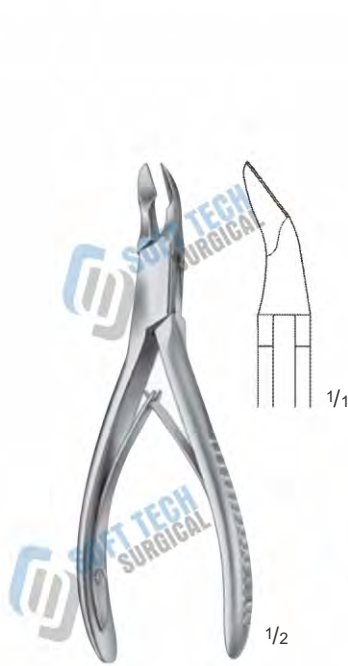

**BONE CUTTING  
FORCEPS**  
**26-0550**  
130 mm



**STAMM BONE CUTTING  
FORCEPS**  
**26-0555**  
150 mm

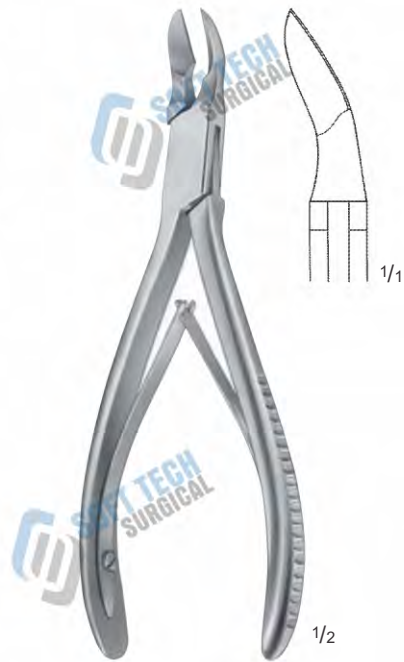

**STAMM BONE CUTTING  
FORCEPS**  
**26-0560**  
170 mm



**KAZANJIAN BONE  
CUTTING FORCEPS**  
**26-0565**  
185 mm



**LISTON, BONE CUTTING  
FORCEPS**

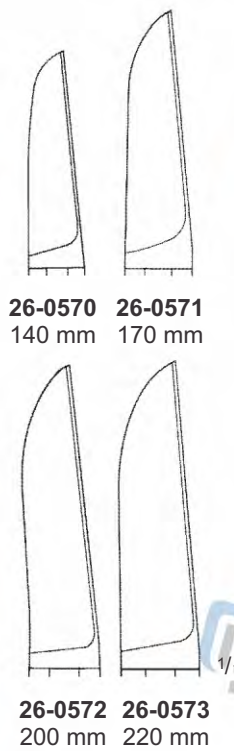

**LISTON, BONE CUTTING  
FORCEPS**





**BÖHLER, BONE CUTTING  
FORCEPS**  
**26-0580**  
145 mm



**BOEHLER, BONE CUTTING  
FORCEPS**  
**26-0585**  
145 mm



**BONE CUTTING FORCEPS**  
**26-0590**  
170 mm



**MC INDOE BONE  
CUTTING FORCEPS**  
**26-0595**  
175 mm



**RUSKIN- LISTON, BONE  
CUTTING FORCEPS**  
**26-0600**  
190 mm

175 mm



**RUSKIN- LISTON, BONE  
CUTTING FORCEPS**  
**26-0605**  
190 mm

SOFT TECH Surgical, Manufacturer & Exporter of Quality Instruments

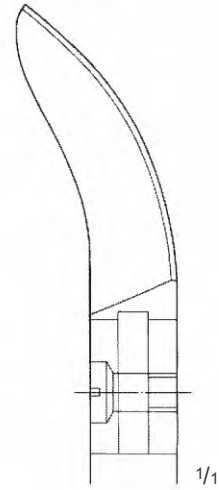
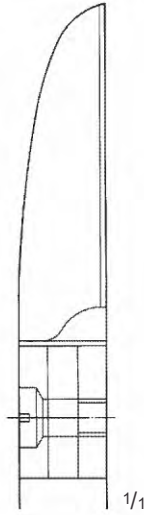
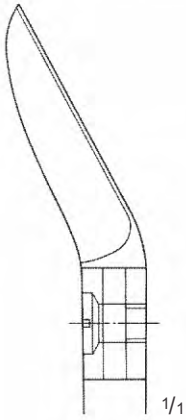

**LISTON BONE CUTTING  
FORCEPS, CURVED**

**26-0610**  
240 mm

**LISTON BONE CUTTING  
FORCEPS, STRAIGHT**

**26-0615**  
280 mm

**LISTON BONE CUTTING  
FORCEPS, CURVED**

**26-0620**  
280 mm

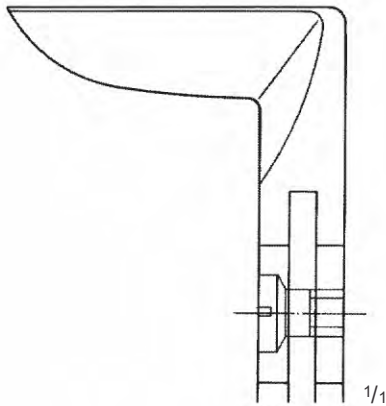

**LISTON- STILLE, BONE CUTTING FORCEPS**  
**21-1505**  
265 mm



**LISTON-KEY BONE CUTTING FORCEPS, S-SHAPED, POSTERIOR RIB ENDS**  
**21-1510**  
255 mm

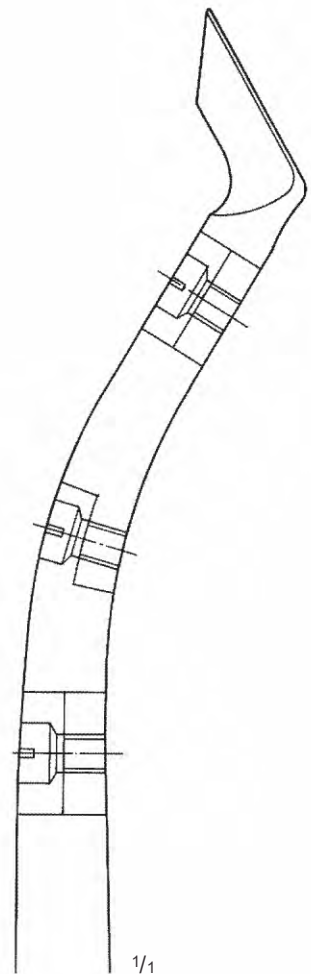



SOFT TECH Surgical, Manufacturer & Exporter of Quality Instruments



**BIRCHER MENISCUS  
FORCEPS STRAIGHT**  
**26-0635**  
200 mm



**BIRCHER MENISCUS  
FORCEPS CURVED**  
**26-0640**  
200 mm



**WELLER, MENISCUS FORCEPS,  
CURVED**  
**26-0645**  
200 mm



**BIRCHER-GANSKE MENISCUS  
FORCEPS, CURVED**  
**26-0650**  
200 mm



**BIRCHER-GANSKE MENISCUS  
FORCEPS, CURVED**  
**26-0655**  
200 mm



**MARTIN, MENISCUS FORCEPS,  
STRAIGHT**  
**26-0660**  
205 mm



SMILLIE MENISCUS  
KNIVES

**26-0665**  
170 mm



SMILLIE MENISCUS  
KNIVES

**26-0670**  
170 mm



SMILLIE MENISCUS  
KNIVES

**26-0675**  
170 mm

SOFT TECH Surgical, Manufacturer & Exporter of Quality Instruments

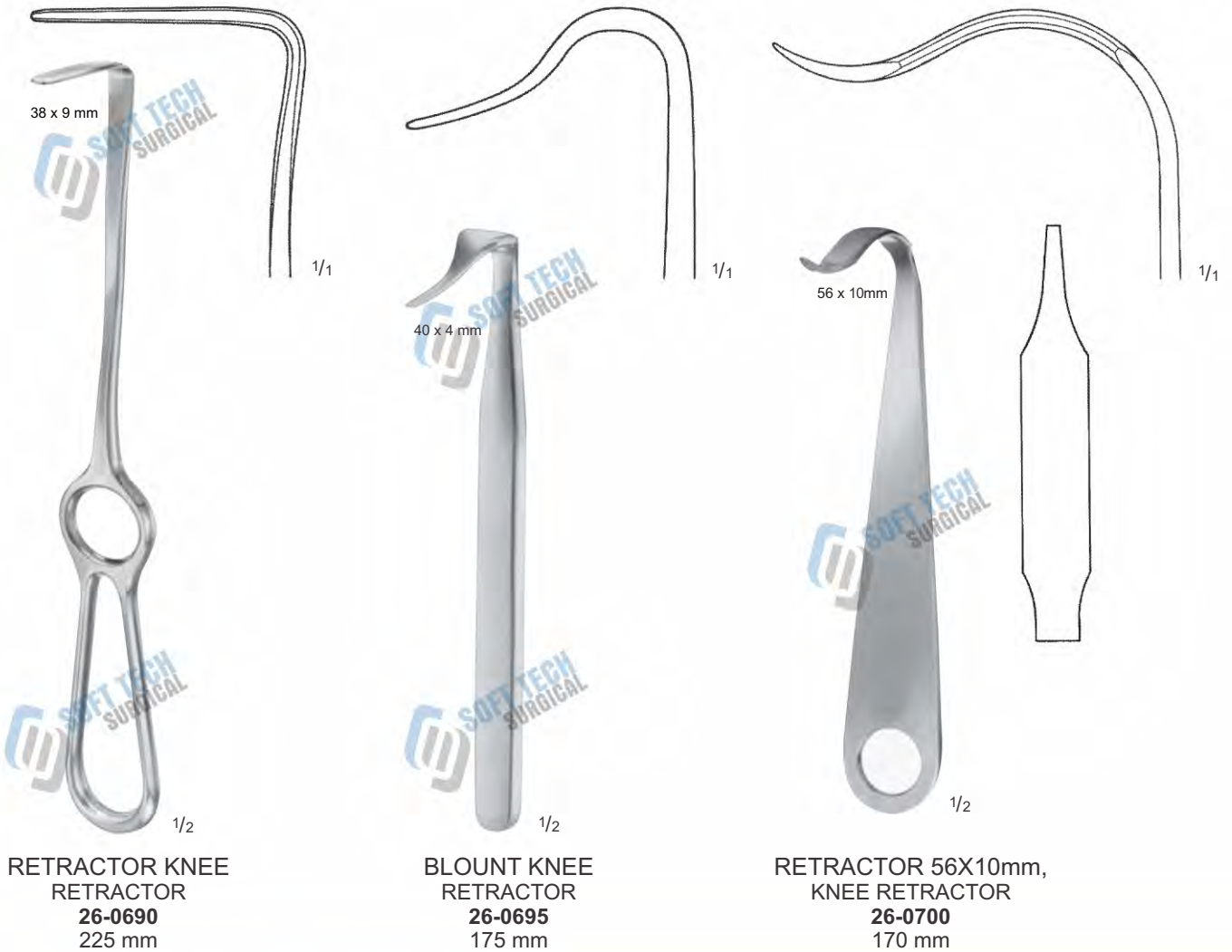
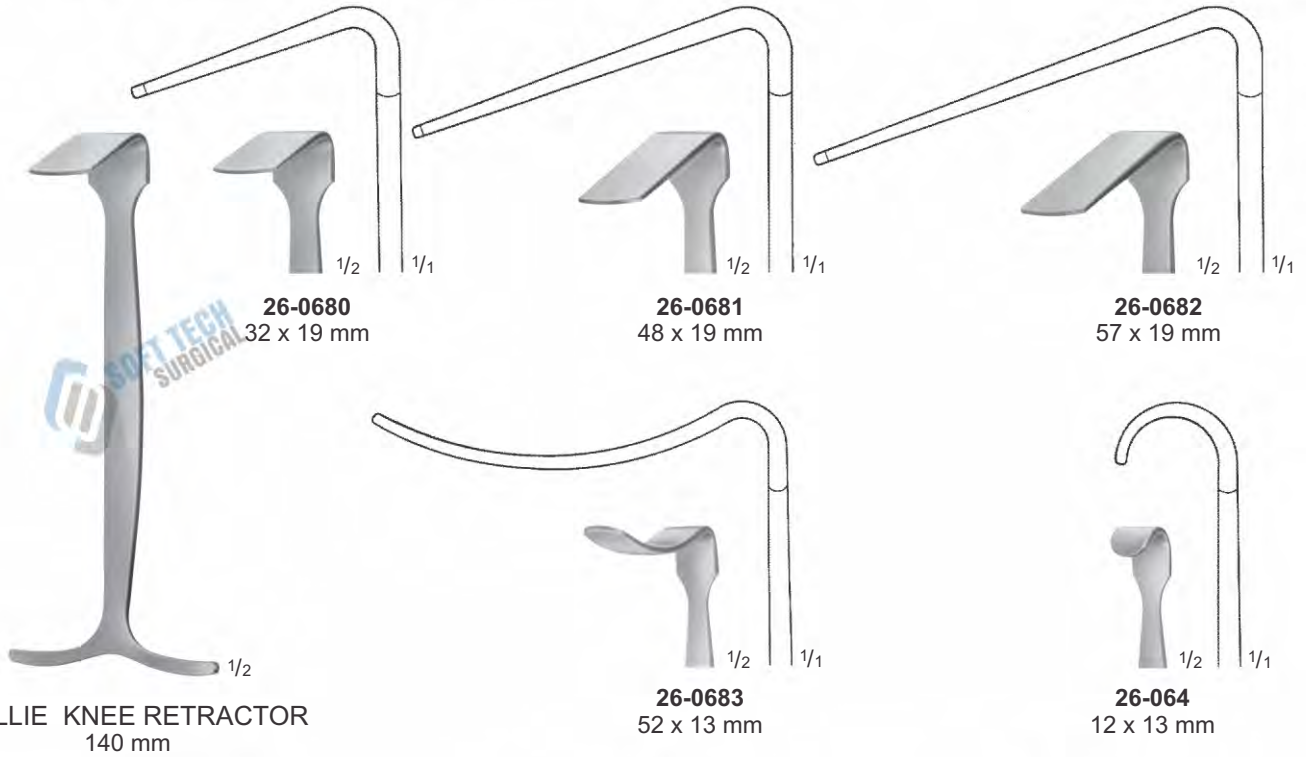





SOFT TECH Surgical, Manufacturer & Exporter of Quality Instruments



**BUNNELL TENDON  
PASSING PROBE**  
**26-0715**  
230 mm



**PROBE WITH EYE**  
**WITH EYE 145 mm**  
2.5 mm diam. of tip  
**26-0720**  
145 mm



**PROBE WITH EYE**  
**WITH EYE 160 mm**  
2.5 mm diam. of tip  
**26-0725**  
160 mm



**PROBE WITH EYE**  
**WITH EYE 200 mm**  
3.0 mm diam. of tip  
**26-0730**  
200 mm



**SOFT TECH  
SURGICAL**

# **General Surgery**

## **Instruments Catalogue**

### **SOFT TECH Surgical**

Muslim Town, Airport Road  
Kotli Behram, Sialkot 51310  
Pakistan.

Email : [info@softtechsurgical.com](mailto:info@softtechsurgical.com)  
Website : [www.softtechsurgical.com](http://www.softtechsurgical.com)

Phone : +92 52 3573488  
+92 52 3242929  
+92 52 4264934  
Fax : +92 52 3242929

 +92 336 4770459