



SOFT TECH
SURGICAL



25
Mallets
Chisels
&
Gouges

SOFT TECH Surgical, Manufacturer & Exporter of Quality Instruments



MEAD MALLET
25-0100 180 g
with interchangeable
plastic discs
190 mm

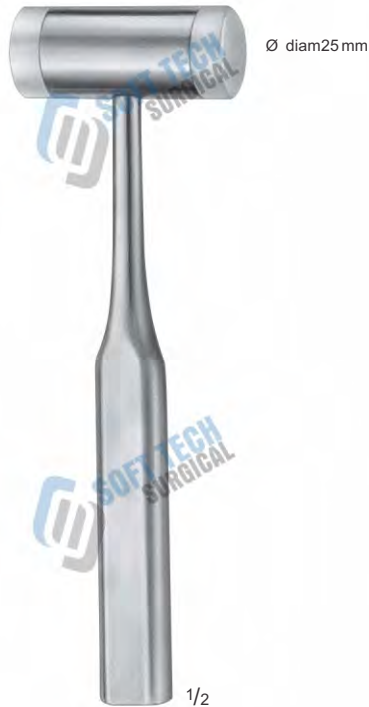

VICKERS MALLET
25-0105 135 g
with interchangeable
plastic discs
185 mm



COTTLE MALLET
25-0110 235 g
1 side flat, 1 side convex
185 mm



LUCAE MALLET
25-0115 130 g
with one smooth and one
rough surface
185 mm



**MALLET LEAD
FILLED**
25-0120 80 g
165 mm



**MALLET LEAD
FILLED**
25-0125 155 g
190 mm



HAJEK Mallet
25-0130 135 g
220 mm



Ultra Fine Mallet
170mm
Head size 20mm Ø
Weight 145g
25-0135



Mallet Lead Filled
25-0140 200 g
with interchangeable
plastic discs
245 mm



Mallet with Tufnol Handle
230mm

IMedium head size 35mm Ø
Weight 550gm

25-0145

Large head size 40mm Ø
Weight 700gm

25-0146

Large head size 40mm Ø
Weight 900gm
25-0147

SOFT TECH Surgical, Manufacturer & Exporter of Quality Instruments



Heavy Orthopaedic Mallet
250 mm
Head size 40mm Ø
Weight 900gm

Ergonomic handle
25-0150



London Splint Mallet
180mm
Head size 30mm Ø
Weight 450gm
25-0155



Heath Mallet
190mm
Stainless steel head
Head size 40mm Ø
Weight 1020gm
25-0160

SOFT TECH Surgical, Manufacturer & Exporter of Quality Instruments

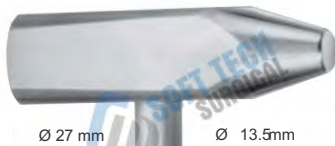

**MALLET LEAD
FILLED**
25-0165
425 gm
235 mm

1/2



**BERGMANN
MALLET**
25-0170
300 gm
245 mm

1/2



**BERGMANN
MALLET**
25-0175
240 gm
235 mm

1/2



**MALLET LEAD
FILLED**
25-0180
285 gm
240 mm

1/2



**OMBREDANNE
MALLET**
25-0185
520 gm
240 mm

1/2



**HEATH
MALLET**
25-0190 660 gm 40 mm 185 mm
25-0191 725 gm 45 mm 200 mm
with cooper filled head

SOFT TECH Surgical, Manufacturer & Exporter of Quality Instruments



FREER CHISEL
25-0200 4 mm
Chisel
160 mm



FREER CHISEL
25-0205 4 mm
Chisel, curved
160 mm



FREER CHISEL
25-0210 6 mm
Gouge
150 mm



MANNERFELT
GOUGE
25-0215 4 mm
25-0216 6 mm
25-0217 8 mm
Osteotomes
155 mm



MANNERFELT
GOUGE
25-0220
3 mm
155 mm



KRÄMER CHISEL
FOR OSTEOPHYTES
25-0225 2.6 mm
with handle
215 mm



OSTEOTOMES

- 25-0230** 4 mm
- 25-0231** 6 mm
- 25-0232** 8 mm
- 25-0233** 10 mm
- 25-0234** 12 mm
- 140 mm



CHISELS

- 25-0240** 4 mm
- 25-0241** 6 mm
- 25-0242** 8 mm
- 25-0243** 10 mm
- 25-0244** 12 mm
- 140 mm



GILLIES OSTEOTOMES

- 25-0245** 5 mm
- 25-0246** 7 mm
- 25-0247** 9 mm
- 140 mm



GOUGES

- 25-0250** 4 mm
- 25-0251** 6 mm
- 25-0252** 8 mm
- 25-0253** 10 mm
- 25-0254** 12 mm
- 140 mm

SOFT TECH Surgical, Manufacturer & Exporter of Quality Instruments



PARTSCH CHISELS

- 25-0255** 3 mm
- 25-0256** 4 mm
- 25-0257** 5 mm
- 25-0258** 6 mm
- 140 mm



PARTSCH CHISELS

- 25-0260** 3 mm
- 25-0261** 4 mm
- 25-0262** 5 mm
- 25-0263** 6 mm
- 25-0264** 7 mm
- 170 mm



PARTSCH GOUGES

- 25-0270** 3 mm
- 25-0271** 4 mm
- 25-0272** 5 mm
- 25-0273** 6 mm
- 140 mm



PARTSCH GOUGES

- 25-0275** 3 mm
- 25-0276** 4 mm
- 25-0277** 5 mm
- 25-0278** 6 mm
- 25-0279** 7 mm
- 170 mm



LUCAS CHISELS
25-0285 4 mm
25-0286 6 mm
160 mm



LUCAS GOUGES
25-0290 3 mm
25-0291 5 mm
160 mm



ALEXANDER GOUGES
25-0295 7 mm
25-0296 9 mm
25-0297 11 mm
170 mm



LAMBOTTE OSTEOTOMES
25-0300 4 mm
25-0301 6 mm
25-0302 8 mm
25-0303 10 mm
25-0304 12 mm
25-0305 15 mm
125 mm



COTTLE OSTEOTOMES
25-0310 4 mm
25-0311 6 mm
25-0312 8 mm
25-0313 10 mm
25-0314 12 mm
with depth markings
180 mm



COTTLE CHISEL-OSTEOTOMES
25-0315 4 mm
25-0316 7 mm
25-0317 9 mm
25-0318 12 mm
with depth markings
180 mm



COTTLE FISHTAIL CHISEL
25-0320 8 mm
with protected ends
180 mm

SOFT TECH Surgical, Manufacturer & Exporter of Quality Instruments



STILLÉ CHISEL

- 25-0330** 10 mm
- 25-0331** 12 mm
- 25-0332** 15 mm
- 25-0333** 20 mm
- 25-0334** 25 mm
- 205 mm



STILLÉ GOUGES

- 25-0340** 10 mm
- 25-0341** 12 mm
- 25-0342** 15 mm
- 25-0343** 20 mm
- 25-0344** 25 mm
- 205 mm

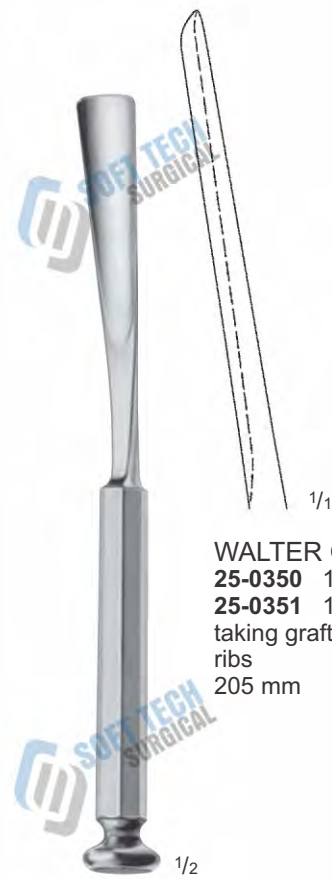

WALTER GOUGES

- 25-0350** 10 mm
- 25-0351** 15 mm
- taking grafts from the ribs
- 205 mm



STILLÉ OSTEOTOMES

- 25-0360** 8 mm
- 25-0361** 10 mm
- 25-0362** 12 mm
- 25-0363** 15 mm
- 25-0364** 20 mm
- 25-0365** 25 mm
- 205 mm

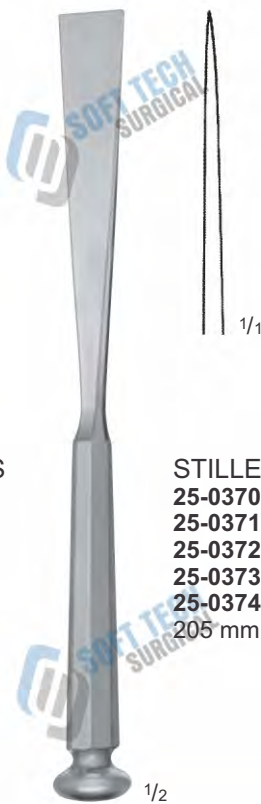

STILLÉ OSTEOTOMES

- 25-0370** 10 mm
- 25-0371** 12 mm
- 25-0372** 15 mm
- 25-0373** 20 mm
- 25-0374** 25 mm
- 205 mm



**STILLÉ OSTEOTOMES
CURVED**

- 25-0380** 10 mm
- 25-0381** 12 mm
- 25-0382** 15 mm
- 25-0383** 20 mm
- 25-0384** 25 mm
- 205 mm



	STRAIGHT	CURVED	STRAIGHT	CURVED
mm				
06	12-0390	12-0400	12-0410	12-0420
09	12-0391	12-0401	12-0411	12-0421
13	12-0392	12-0402		
14	12-0393		12-0412	12-0422
16	12-0394	12-0403	12-0413	12-0423
19	12-0395	12-0404	12-0414	12-0424
25	12-0396	12-0405	12-0415	12-0425
32	12-0397	12-0406	12-0416	12-0426

SMITH-PETERSEN
205 mm



HIBBS OSTEOTOME
240 mm

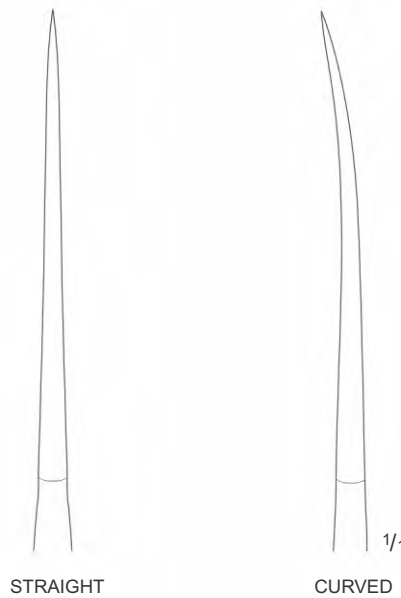

1/1

	STRAIGHT		CURVED
25-0430	6 mm	25-0440	6 mm
25-0431	10 mm	25-0441	10 mm
25-0432	13 mm	25-0442	13 mm
25-0433	16 mm	25-0443	16 mm
25-0434	19 mm	25-0444	19 mm
25-0435	22 mm	25-0445	22 mm
25-0436	25 mm	25-0446	25 mm
25-0437	28 mm	25-0447	28 mm
25-0438	32 mm	25-0448	32 mm
25-0439	38 mm	25-0449	38 mm

SOFT TECH Surgical, Manufacturer & Exporter of Quality Instruments



**LAMBOTTE
OSTEOTOMES**

- 25-0450** 4 mm
- 25-0451** 8 mm
- 25-0452** 10 mm
- 25-0453** 13 mm
- 25-0454** 15 mm
- 25-0455** 18 mm
- 25-0456** 20 mm
- 25-0457** 25 mm
- 25-0458** 30 mm
- 25-0459** 38 mm
- 25-0460** 44 mm
- 25-0461** 50 mm
- 245 mm

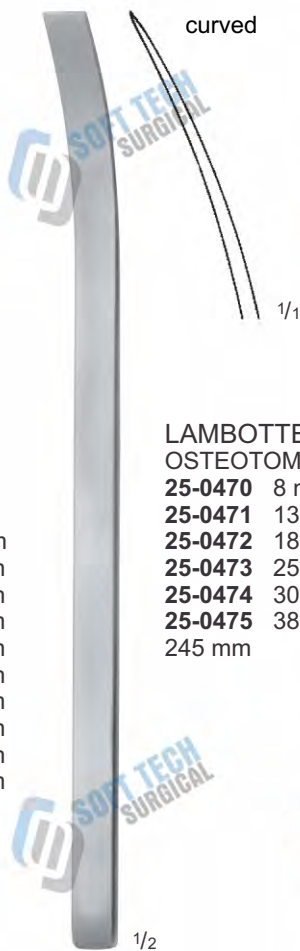

**LAMBOTTE
OSTEOTOMES**

- 25-0470** 8 mm
- 25-0471** 13 mm
- 25-0472** 18 mm
- 25-0473** 25 mm
- 25-0474** 30 mm
- 25-0475** 38 mm
- 245 mm

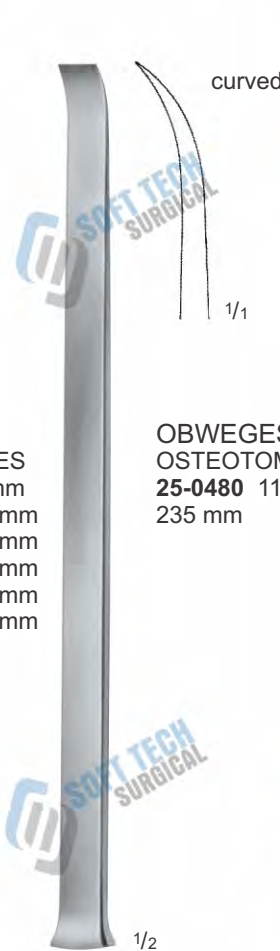

**OBWEGESER
OSTEOTOMES**

- 25-0480** 11 mm
- 235 mm



**NIEDERDELLMANN
OSTEOTOMES**

- 25-0485** 8 mm
- 25-0486** 10 mm
- 250 mm



CHISEL
25-0490 10 mm
25-0491 15 mm
25-0492 20 mm
200 mm



CHISEL, CURVED
25-0495 10 mm
25-0496 15 mm
25-0497 20 mm
200 mm



**LEXER-MINI
OSTEOTOMES**
25-0500 4 mm
25-0501 6 mm
25-0502 8 mm
25-0503 10 mm
25-0504 12 mm
180 mm



**LEXER-MINI
GOUGES**
25-0510 4 mm
25-0511 6 mm
25-0512 8 mm
25-0513 10 mm
25-0514 12 mm
180 mm



LEXER OSTEOTOMES

25-0520	5 mm
25-0521	7 mm
25-0522	10 mm
25-0523	15 mm
25-0524	20 mm
25-0525	25 mm
25-0526	30 mm
	220 mm

LEXER GOUGES

25-0530	5 mm
25-0531	7 mm
25-0532	10 mm
25-0533	15 mm
25-0534	20 mm
25-0535	25 mm
25-0536	30 mm
	220 mm

**LEXER GOUGE
REMOVING BROKEN
SCREWS**

25-0540	9 mm
	220 mm

**ZIELKE GOUGE
SCOLIOSE OPERATIN**

25-0545	5.5 mm
25-046	9.0 mm
	230 mm



**CAPENER LAMINA
GOUGE CRANKED**
25-0550 6 mm
25-0551 8 mm
25-0552 11 mm
25-0553 16 mm
 235 mm



SPONGIOSA-GOUGE
25-0560 5 mm
25-0561 10 mm
25-0562 15 mm
 250 mm

SOFT TECH Surgical, Manufacturer & Exporter of Quality Instruments

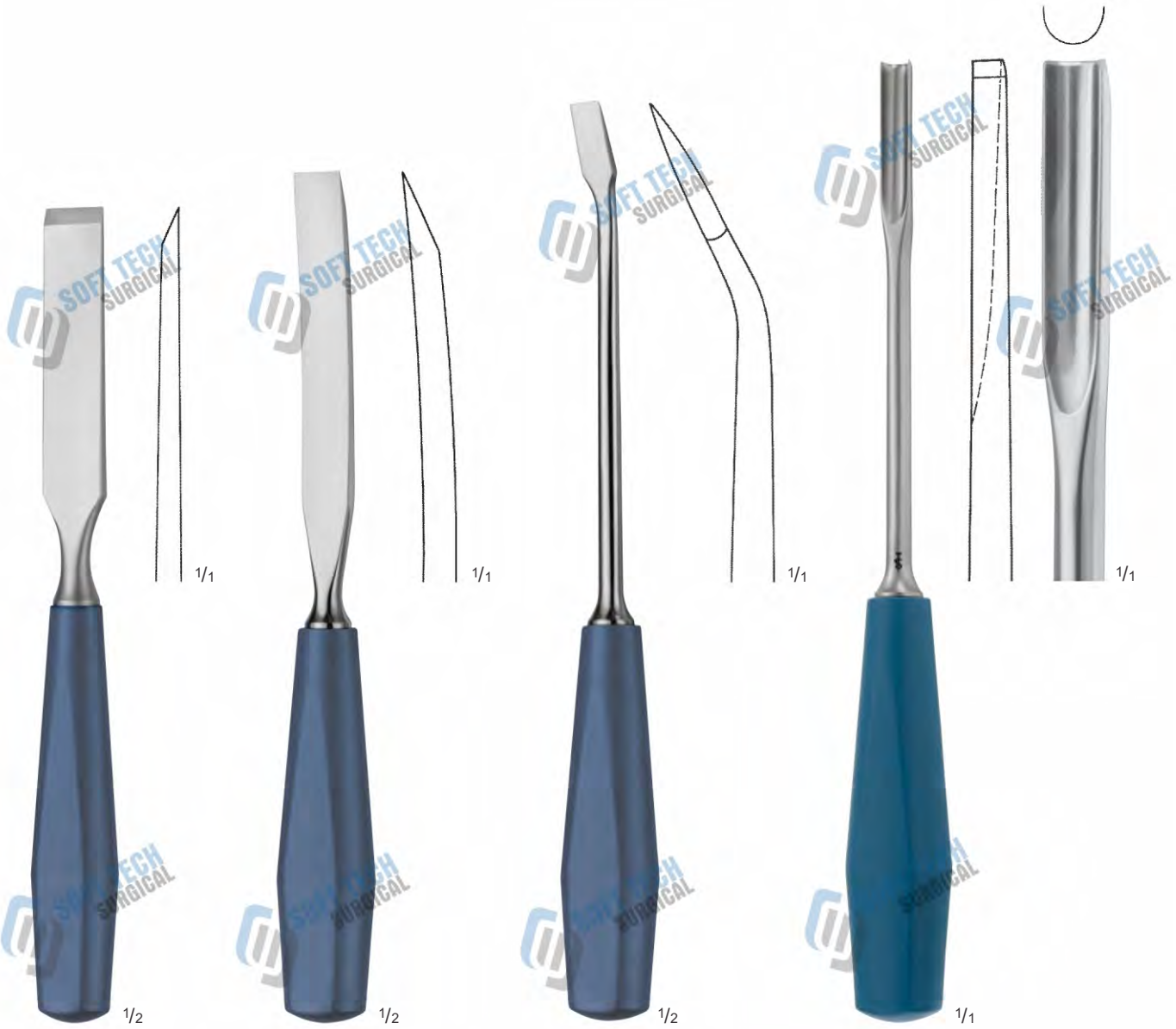

CHISEL
25-0565 20 mm
245 mm

**CHISEL PEEK-HANDLE,
CURVED**
25-0570 16 mm
265 mm

**LEXER OSTEOTOMES
ANGLED**
25-0575 10 mm
25-0576 15 mm
275 mm

**LEXER SPONGIOSA
GOUGE**
25-0580
280 mm



**SOFT TECH
SURGICAL**

General Surgery

Instruments Catalogue

SOFT TECH Surgical

Muslim Town, Airport Road
Kotli Behram, Sialkot 51310
Pakistan.

Email : info@softtechsurgical.com
Website : www.softtechsurgical.com

Phone : +92 52 3573488
+92 52 3242929
+92 52 4264934
Fax : +92 52 3242929

 +92 336 4770459