



SOFT TECH  
SURGICAL

24

Bone Levers  
&  
Periosteal  
Elevators



SOFT TECH Surgical, Manufacturer & Exporter of Quality Instruments



**PENFIELD DISSECTOR**  
**24-0100**  
Fig. 1  
double-ended  
175 mm

**PENFIELD DISSECTOR**  
**24-0105**  
Fig. 2  
double-ended  
195 mm

**PENFIELD DISSECTOR**  
**24-0110**  
Fig. 3  
double-ended  
195 mm

**PENFIELD, DISSECTOR**  
**24-0115**  
Fig. 4  
slightly curved  
205 mm



**SWEDISH DISSECTOR**  
24-0120 180 mm  
24-0121 200 mm

**PENNYBACKER, PROBE DISSECTOR**  
24-0125 , 230 mm

**O'CONNELL**  
24-0130  
double-ended  
220 mm

**TOENNIS GROOVED DIRECTOR**  
24-0135 , 240 mm

**PENFIELD DISSECTOR**  
24-0140  
double-ended, slightly curved  
290 mm

SOFT TECH Surgical, Manufacturer & Exporter of Quality Instruments



**KÖNIG ELEVATOR**  
155 mm

**BONE LEVER**  
24-0150  
155 mm

**CAIRNS ELEVATOR**  
24-0155  
175 mm

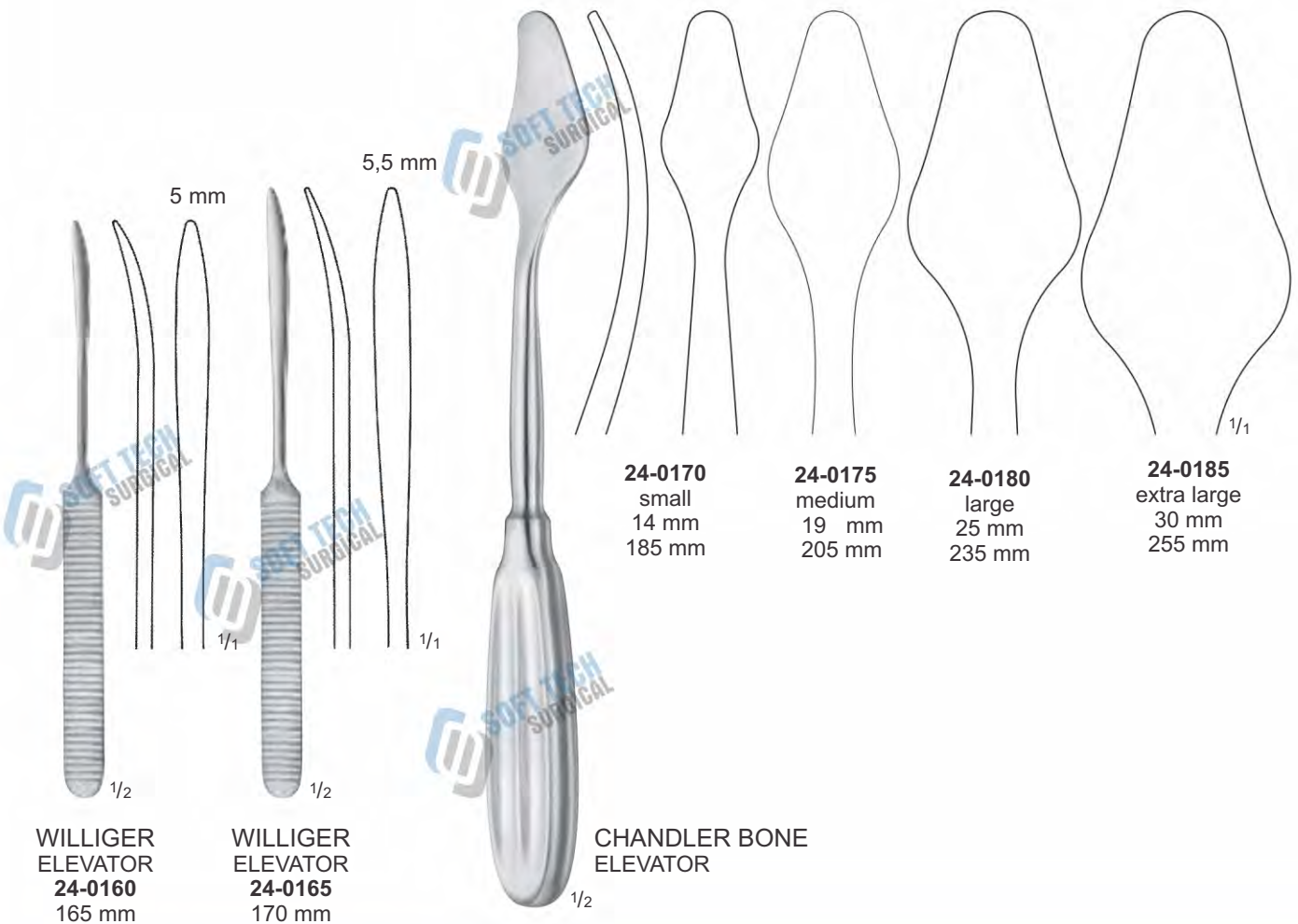

**WILLIGER ELEVATOR**  
24-0160  
165 mm

**WILLIGER ELEVATOR**  
24-0165  
170 mm

**CHANDLER BONE ELEVATOR**



SOFT TECH Surgical, Manufacturer & Exporter of Quality Instruments



**SEBILEAU ELEVATOR**  
**24-0190**  
175 mm

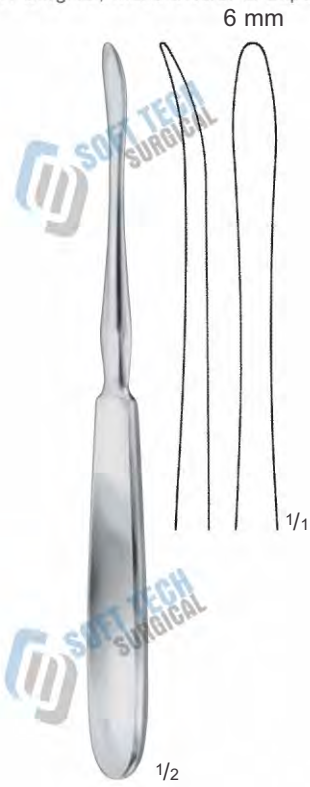

**QUERVAIN ELEVATOR**  
**24-0195**  
195 mm



**LANGENBECK ELEVATOR**  
195 mm

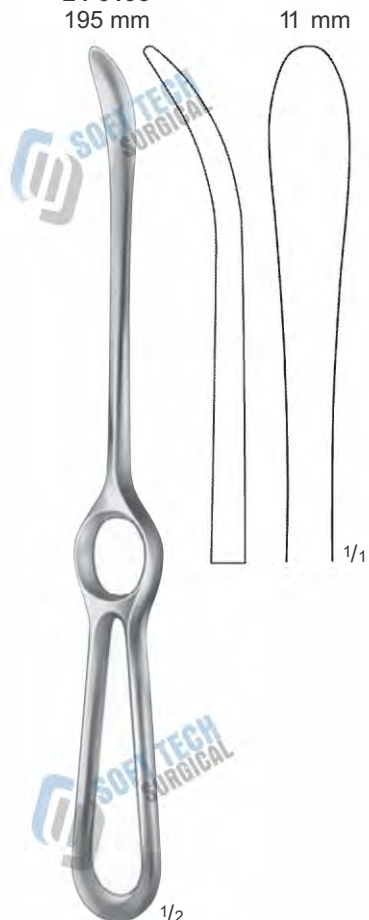

**LANGENBECK BONE LEVER**  
**24-0205**  
230 mm

SOFT TECH Surgical, Manufacturer & Exporter of Quality Instruments



**BONE LEVER**  
**24-0210**  
140 mm

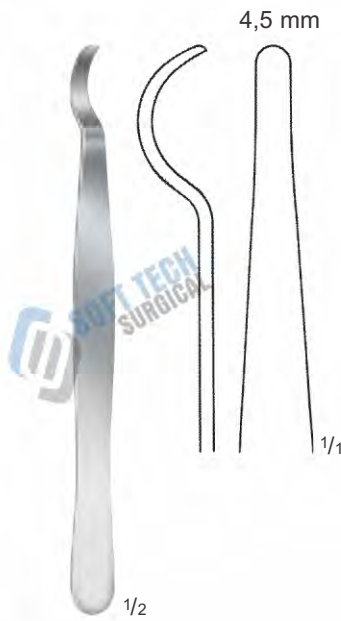

**BONE LEVER**  
**24-0215**  
150 mm

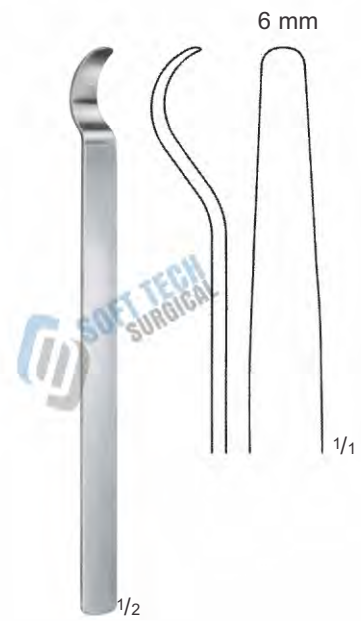

**BONE LEVER**  
**24-0220**  
150 mm



**BUCK-GRAMCKO  
BONE LEVER**  
**24-0225**  
150 mm

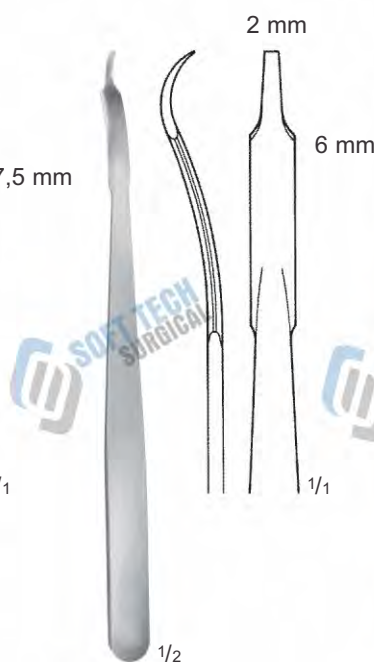

**BONE LEVER**  
**24-0230**  
160 mm

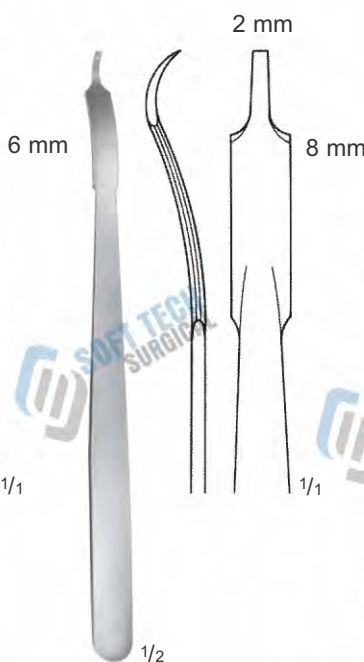

**BONE LEVER**  
**24-0235**  
160 mm



**BONE LEVER**  
**24-0240**  
125 mm



LANE TRETOWAN  
BONE LEVER  
24-0245  
215 mm

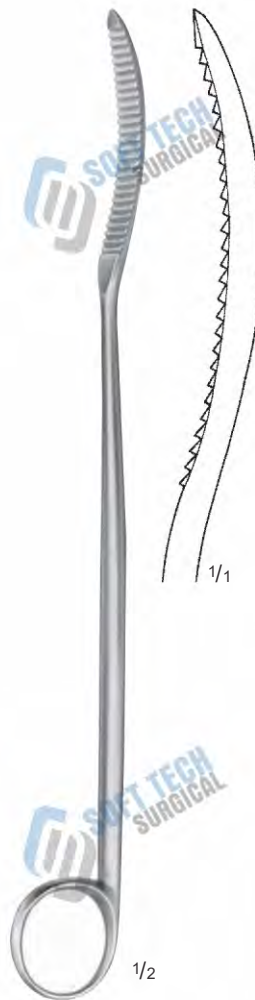

LANE BONE LEVER  
24-0250  
255 mm

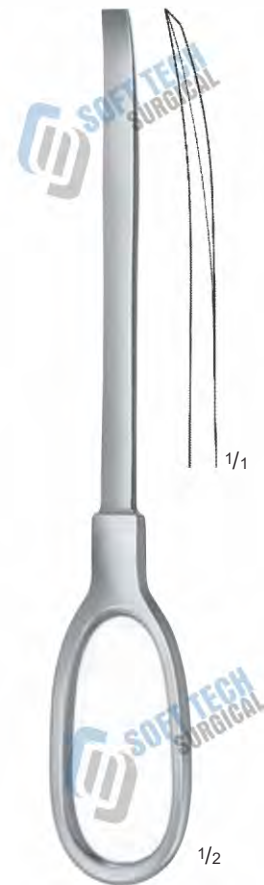

BRISTOW BONE LEVER  
24-0255  
230 mm

SOFT TECH Surgical, Manufacturer & Exporter of Quality Instruments



**WATSON-JONES**  
**24-0260**  
280 mm

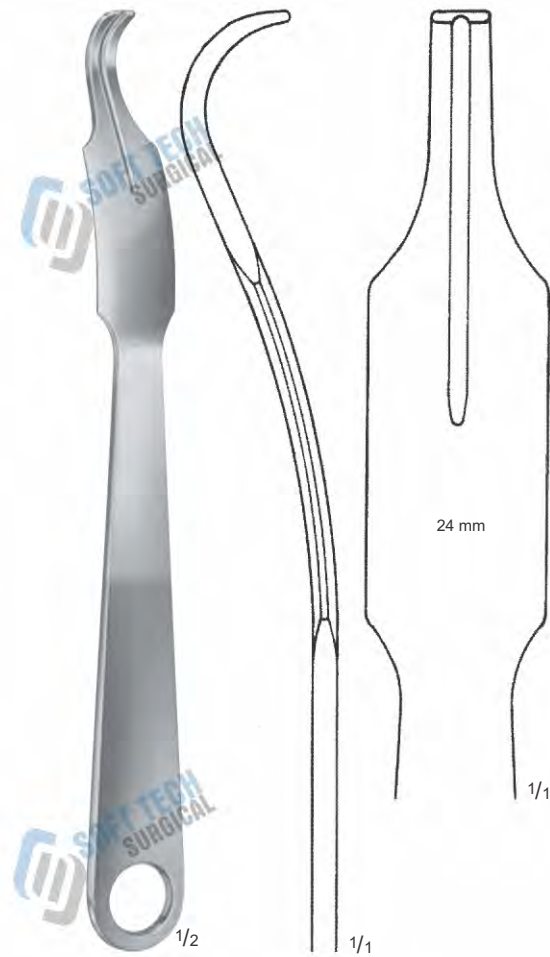

**LANGE-HOHMANN**  
**24-0265**  
250 mm



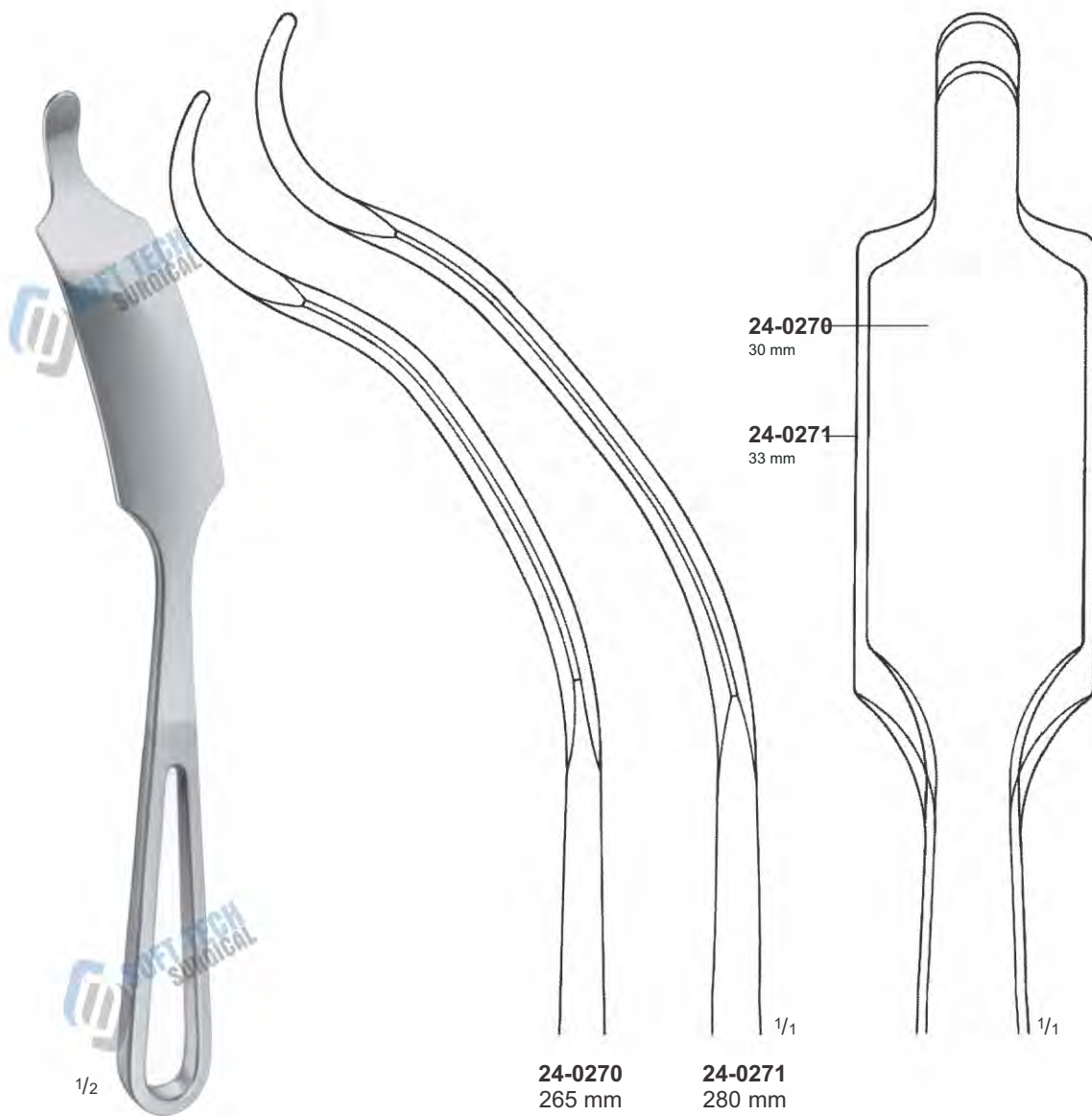

LANGE-HOHMANN  
MODIF, BONE LEVER

SOFT TECH Surgical, Manufacturer & Exporter of Quality Instruments



**WAGNER BONE LEVER**  
**24-0275**  
220 mm

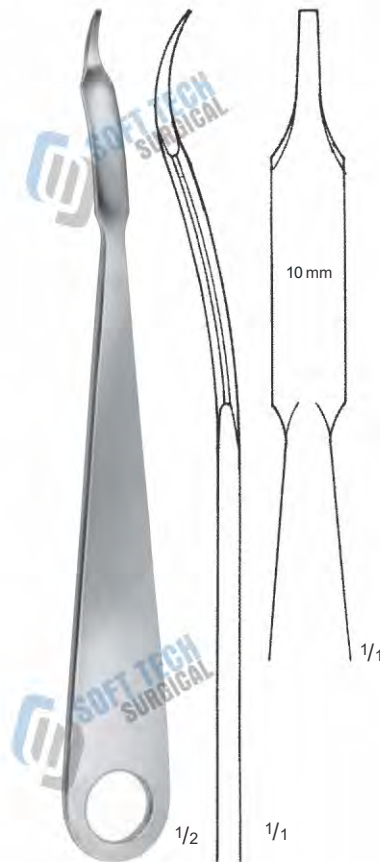

**BONE LEVER**  
**24-0280**  
220 mm

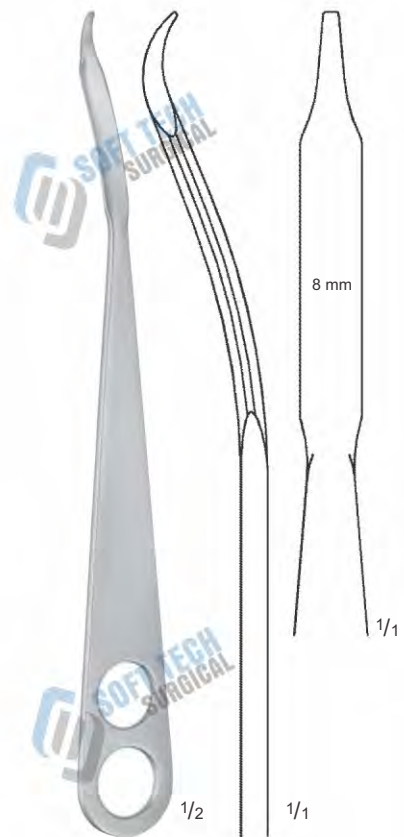

**BONE RETRACTOR**  
**24-0285**  
220 mm

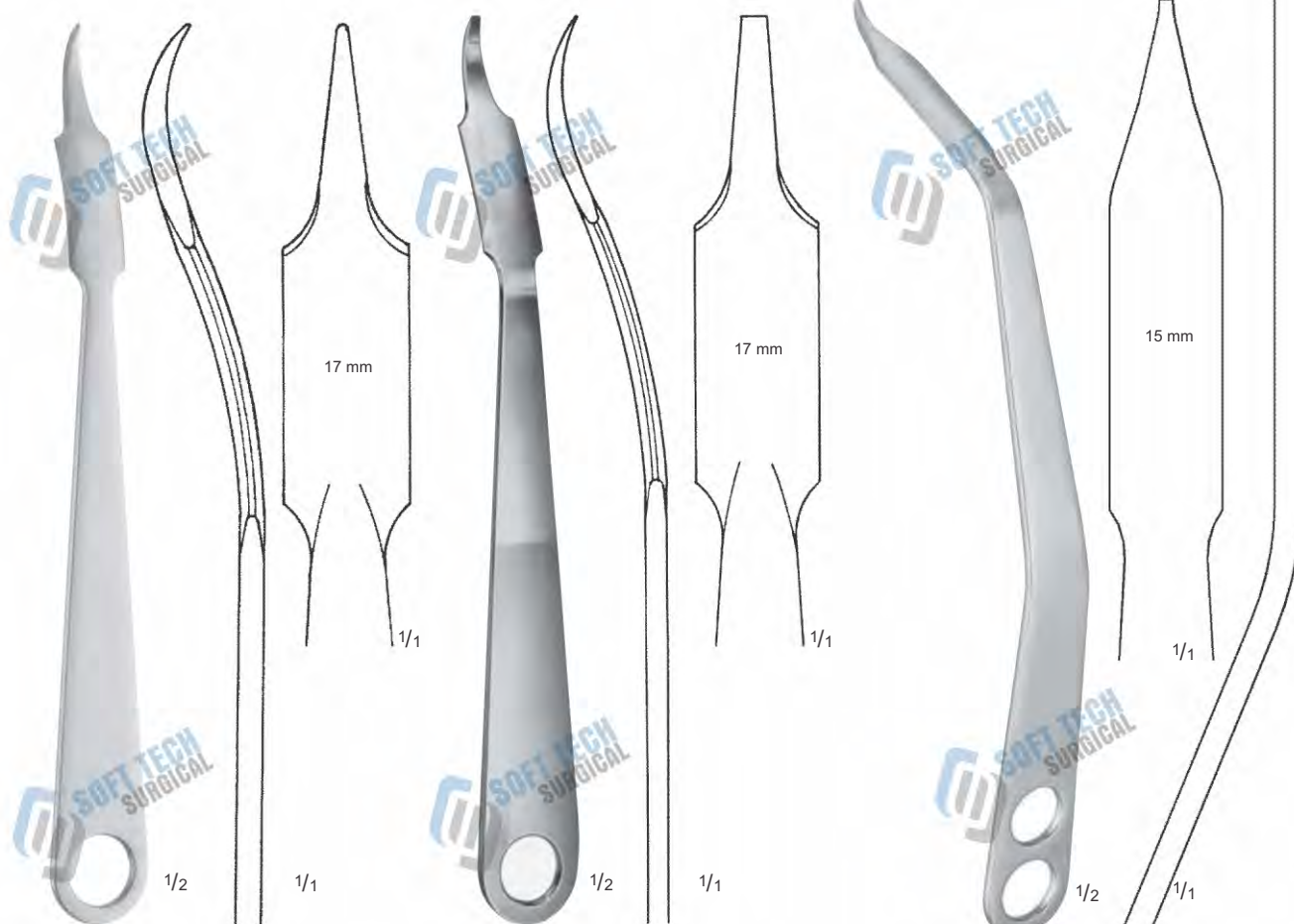

**HOHMANN BONE  
LEVER**  
24-0290  
240 mm

**HOHMANN BONE  
LEVER**  
24-0295  
240 mm

**BONE RETRACTOR**  
24-0300  
250 mm

SOFT TECH Surgical, Manufacturer & Exporter of Quality Instruments

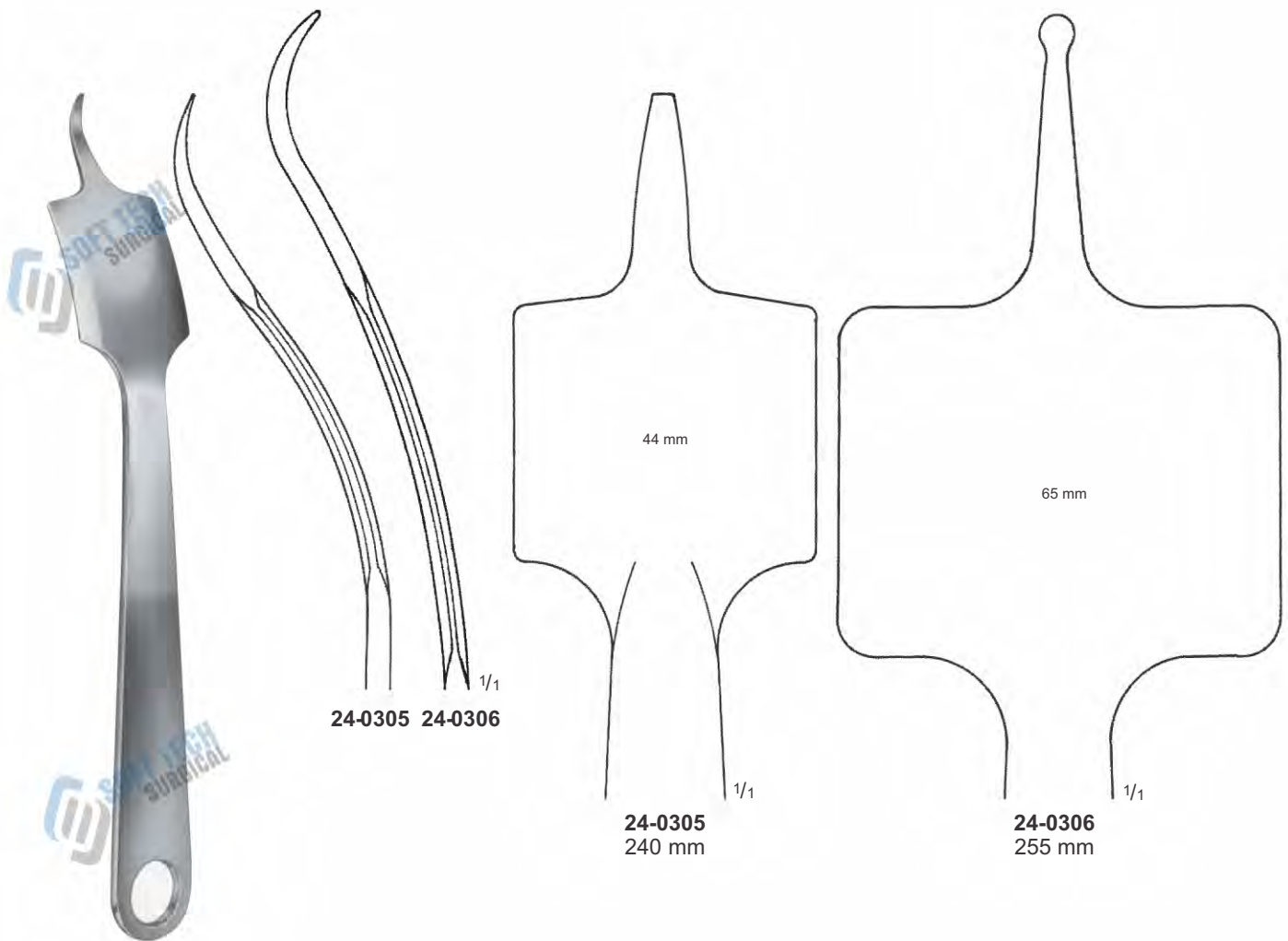

VERBRUGGE- MÜLLER BONE LEVER



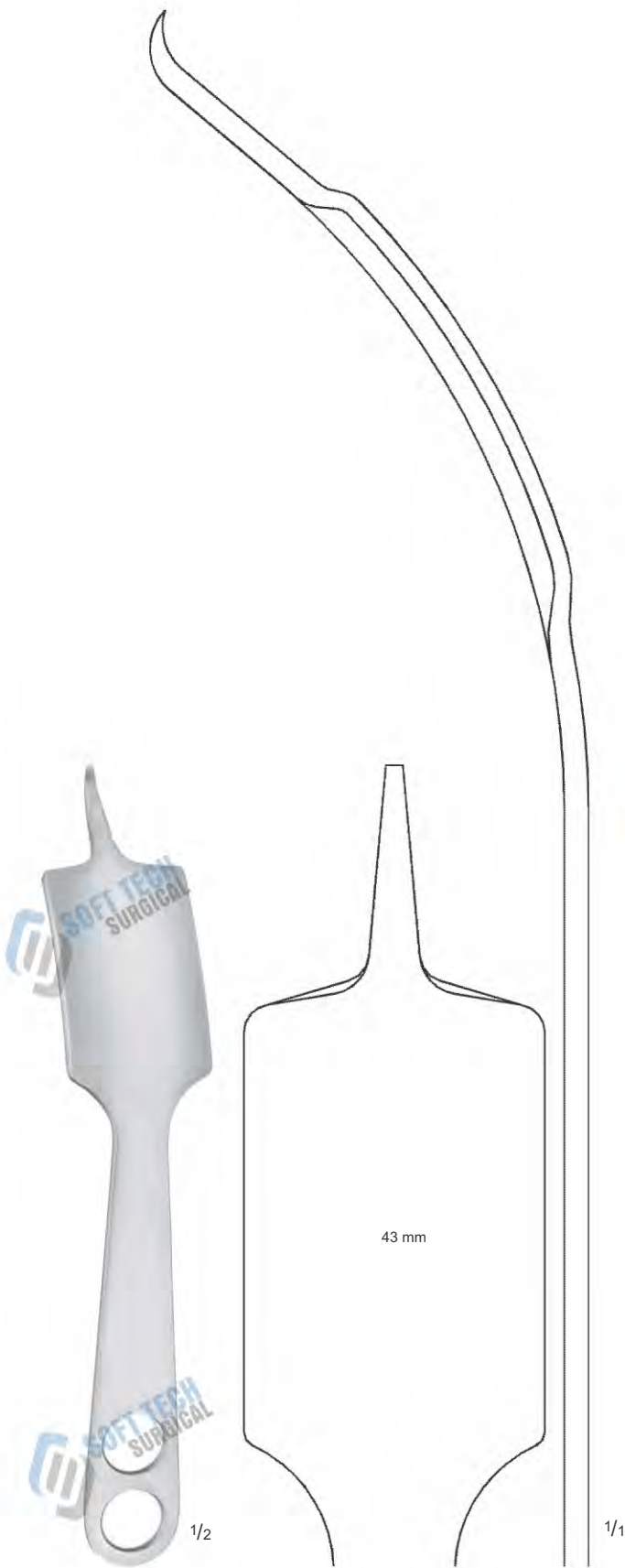

**BONE LEVER**  
**24-0310**  
230 mm

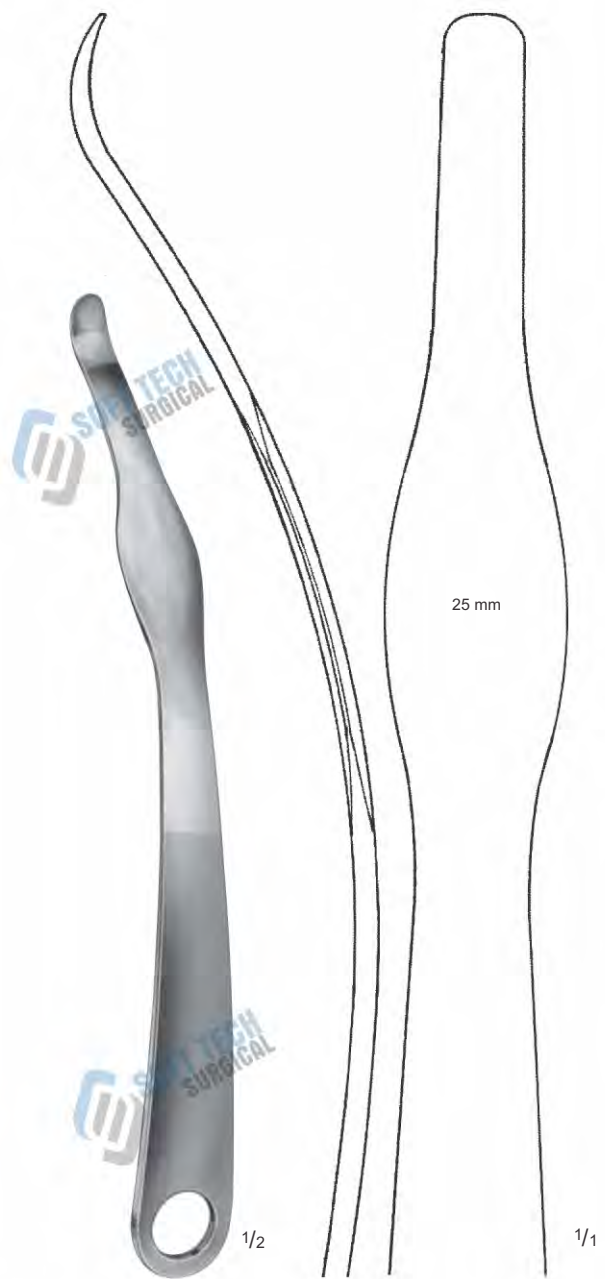

**BONE LEVER**  
**24-0315**  
260 mm

SOFT TECH Surgical, Manufacturer & Exporter of Quality Instruments

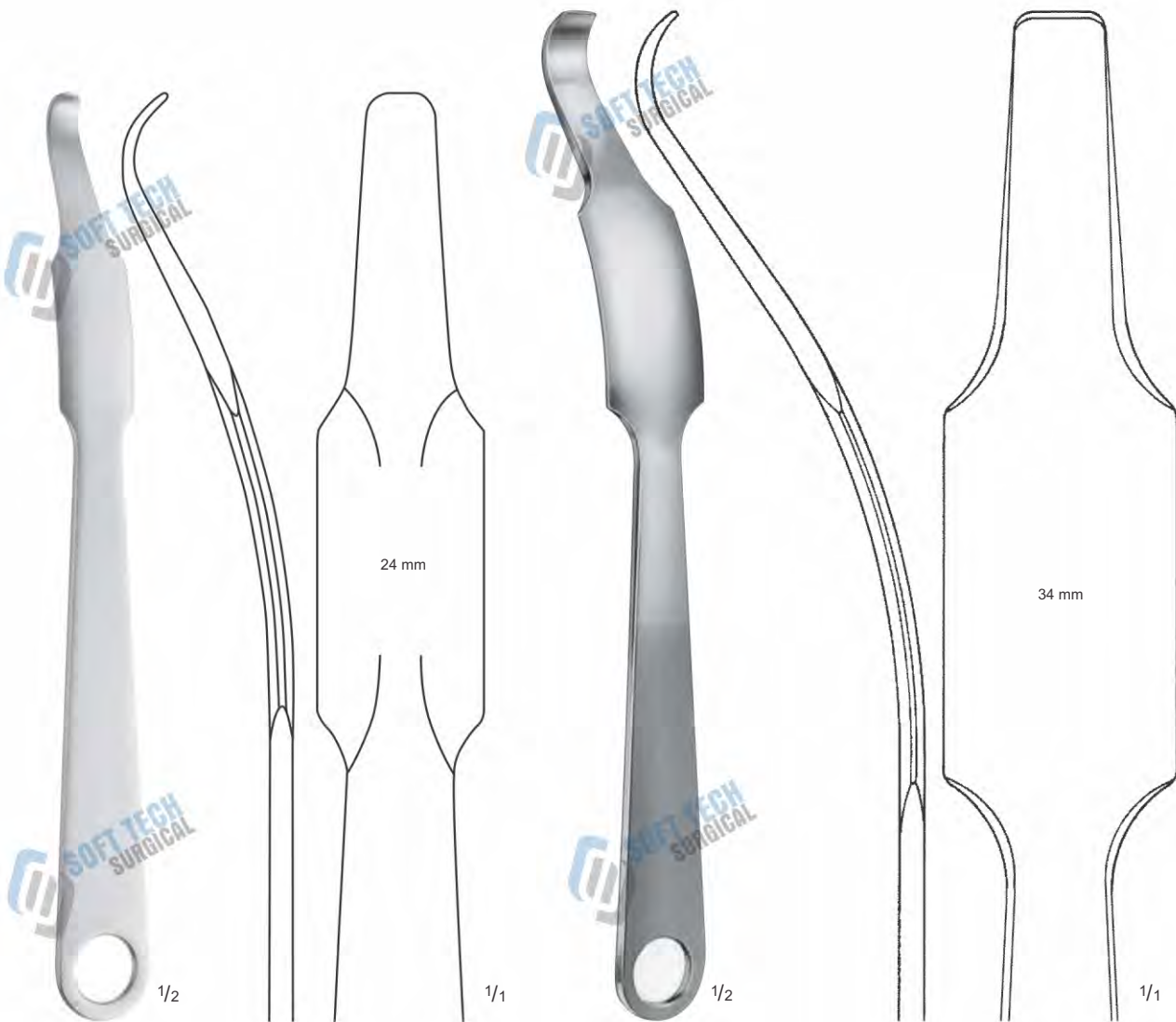

**HOHMANN BONE LEVER**  
**24-0320**  
260 mm

**HOHMANN BONE LEVER**  
**24-0325**  
285 mm

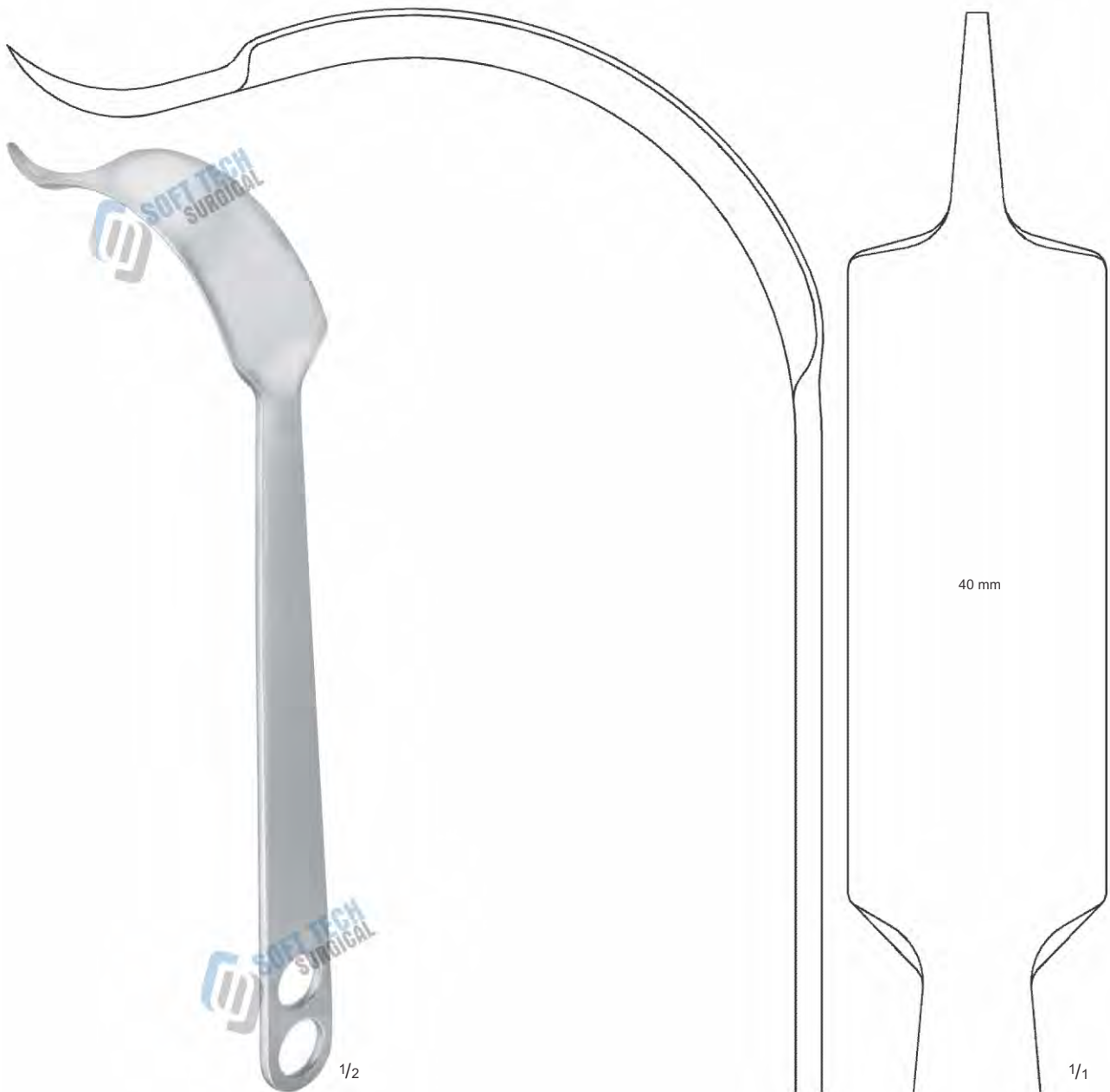

**BONE LEVER**  
**24-0330**  
290 mm

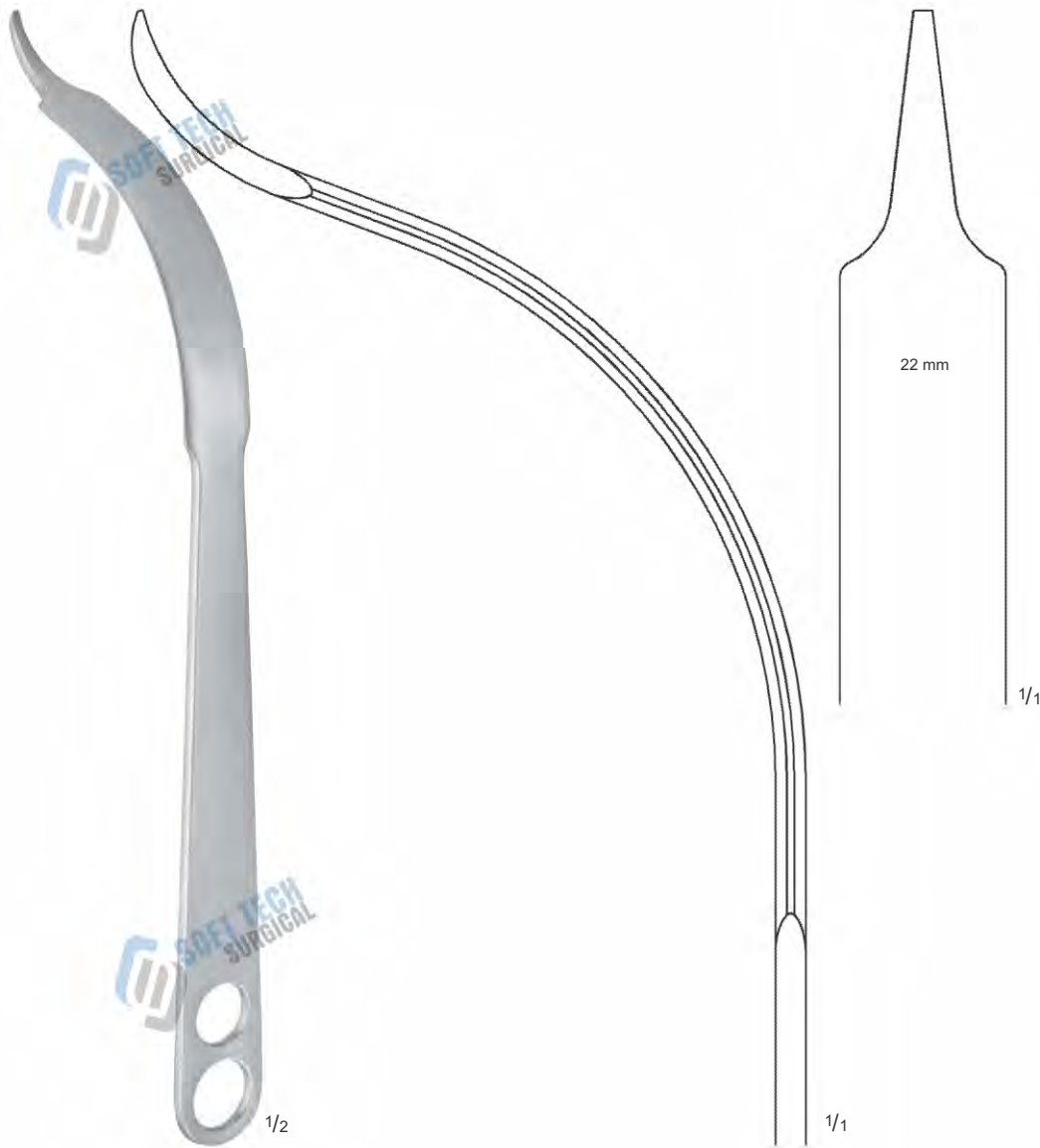

**BONE LEVER**  
**24-0335**  
300 mm



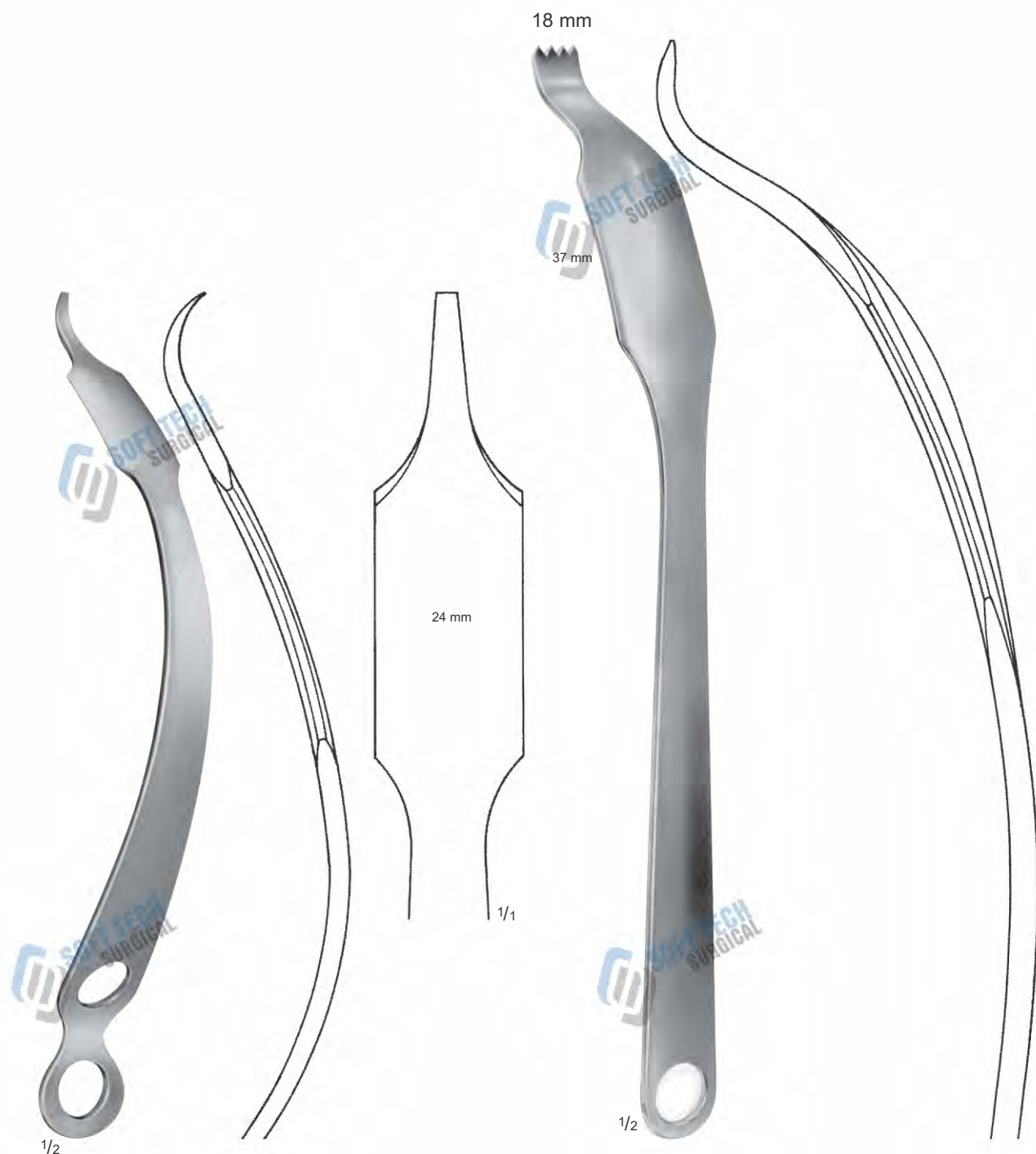

**HOHMANN-ALDINGER  
BONE LEVER**  
24-0340  
270 mm

**SCHUMACHER BONE LEVER**  
24-0345  
355 mm

SOFT TECH Surgical, Manufacturer & Exporter of Quality Instruments

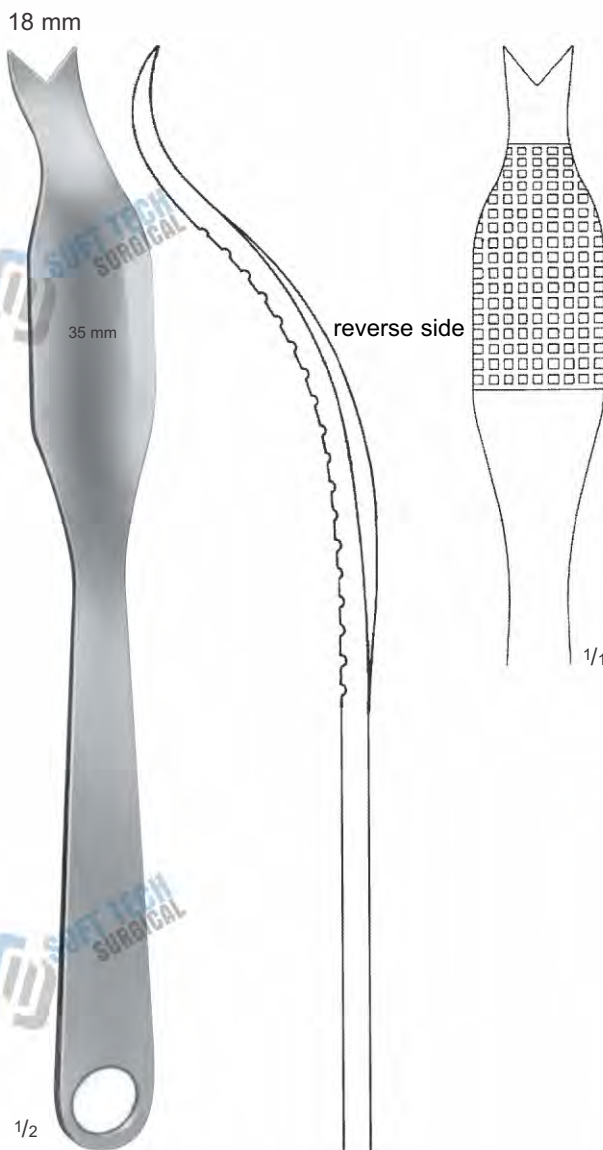

**SCHUMACHER  
BONE LEVER**  
**24-0350**  
290 mm



**TÄGER BONE LEVER FOR  
ANGLE JOINT OPERATIONS**  
**24-0355**  
175 mm



**BENNETT BONE LEVER**  
235 mm

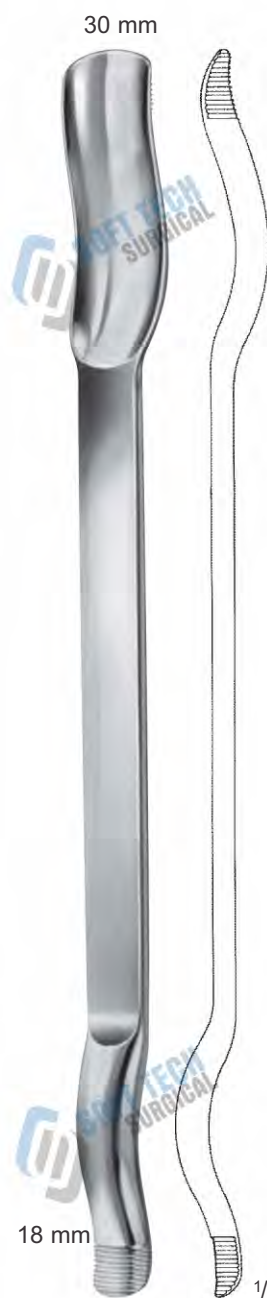

**MURPHY-LANE LUXATION  
LEVER DOUBLE-ENDED**  
**24-0365**  
330 mm

SOFT TECH Surgical, Manufacturer & Exporter of Quality Instruments

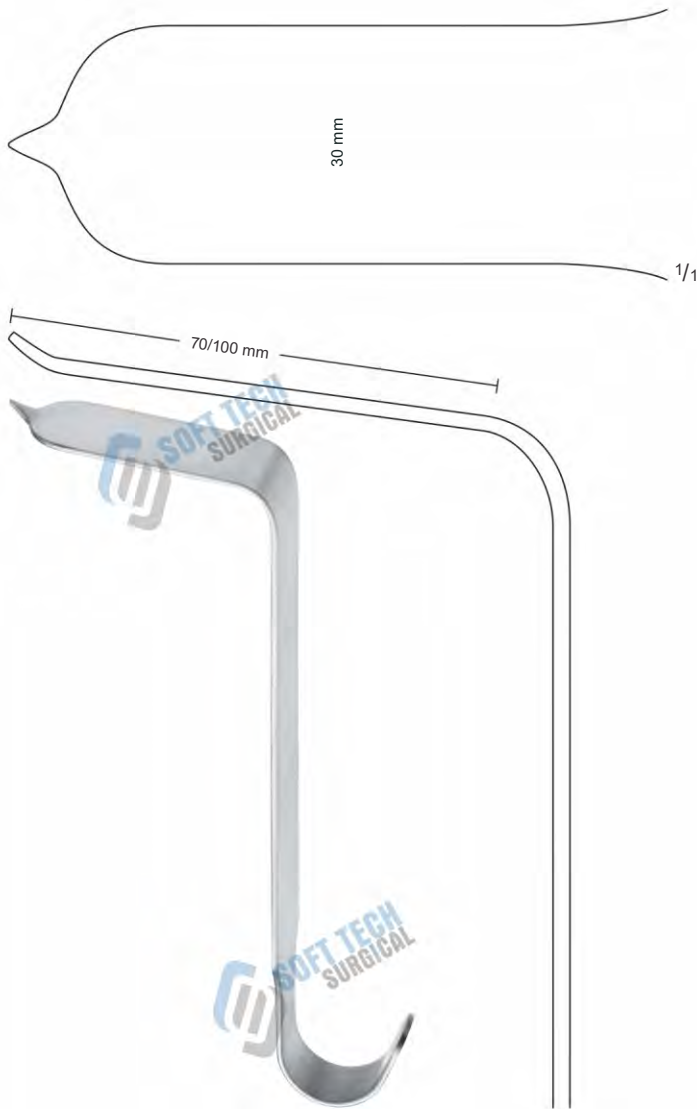

**TAYLOR RETRACTOR**

Blade size:

- 24-0370** 30 x 70 mm 185 mm
- 24-0371** 30 x 100 mm 200 mm

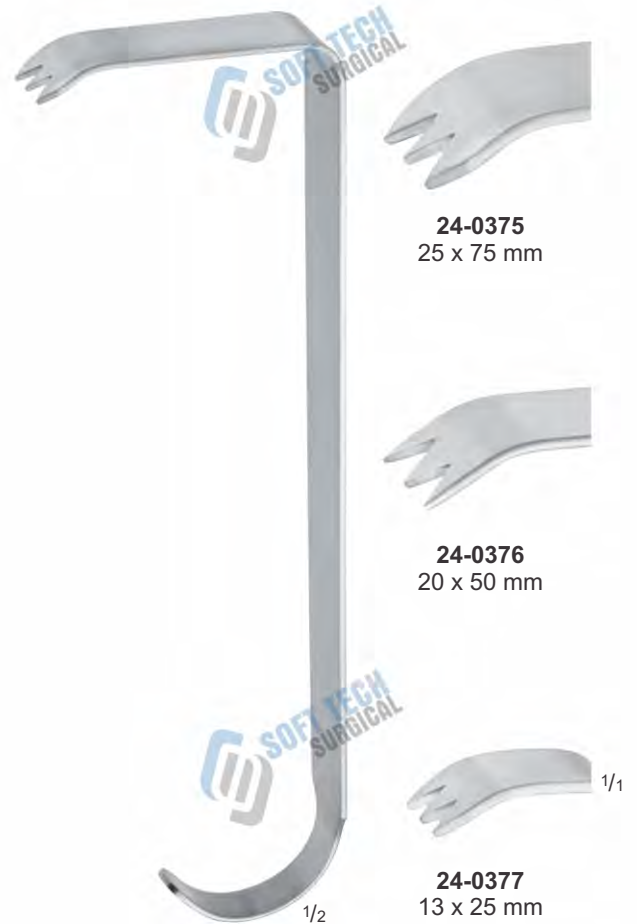

**HIBBS RETRACTOR**

235 mm



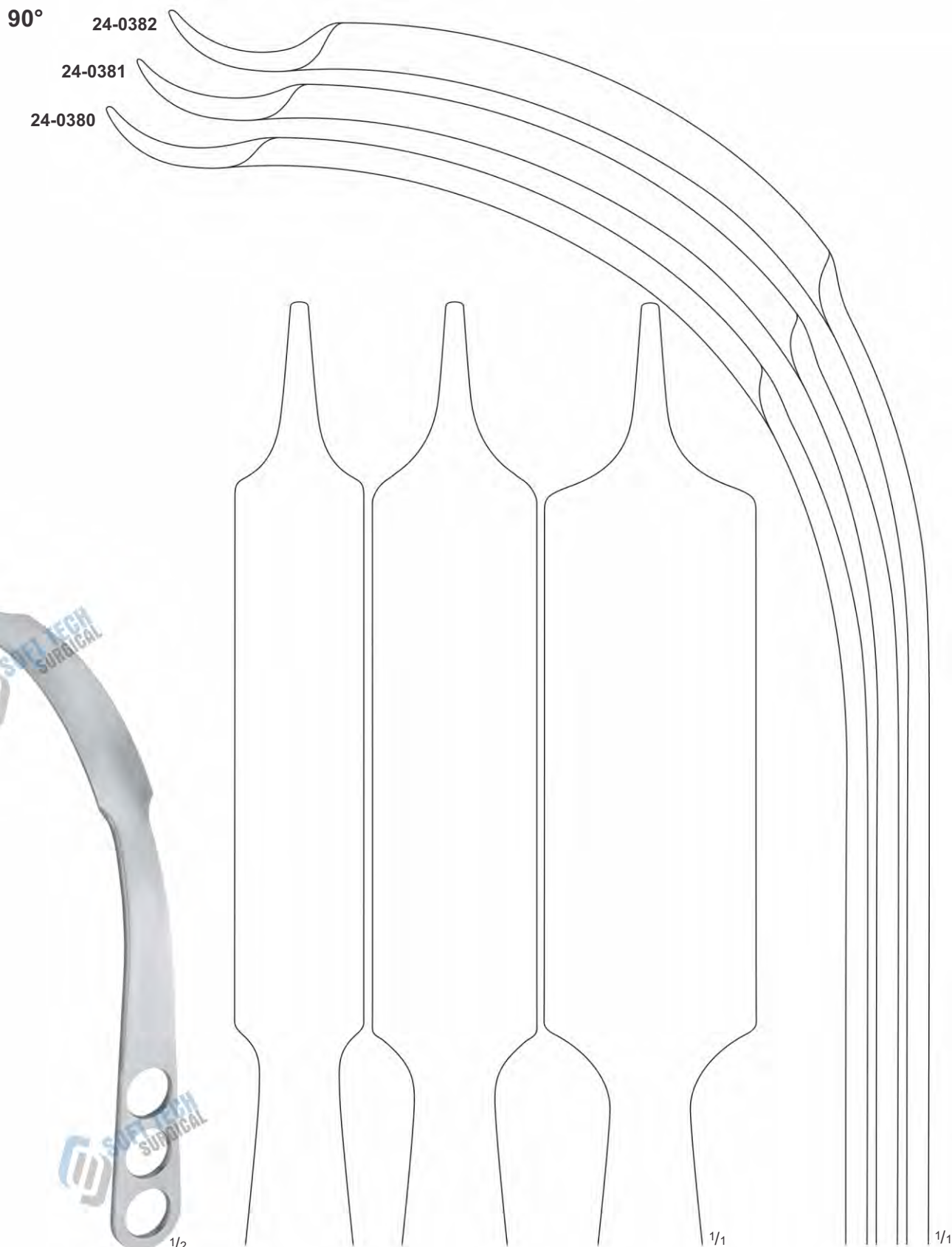

MIOS, HIP RETRACTOR  
sharp tip  
240 mm

**24-0380**  
22 mm

**24-0381**  
28 mm

**24-0382**  
40 mm

SOFT TECH Surgical, Manufacturer & Exporter of Quality Instruments

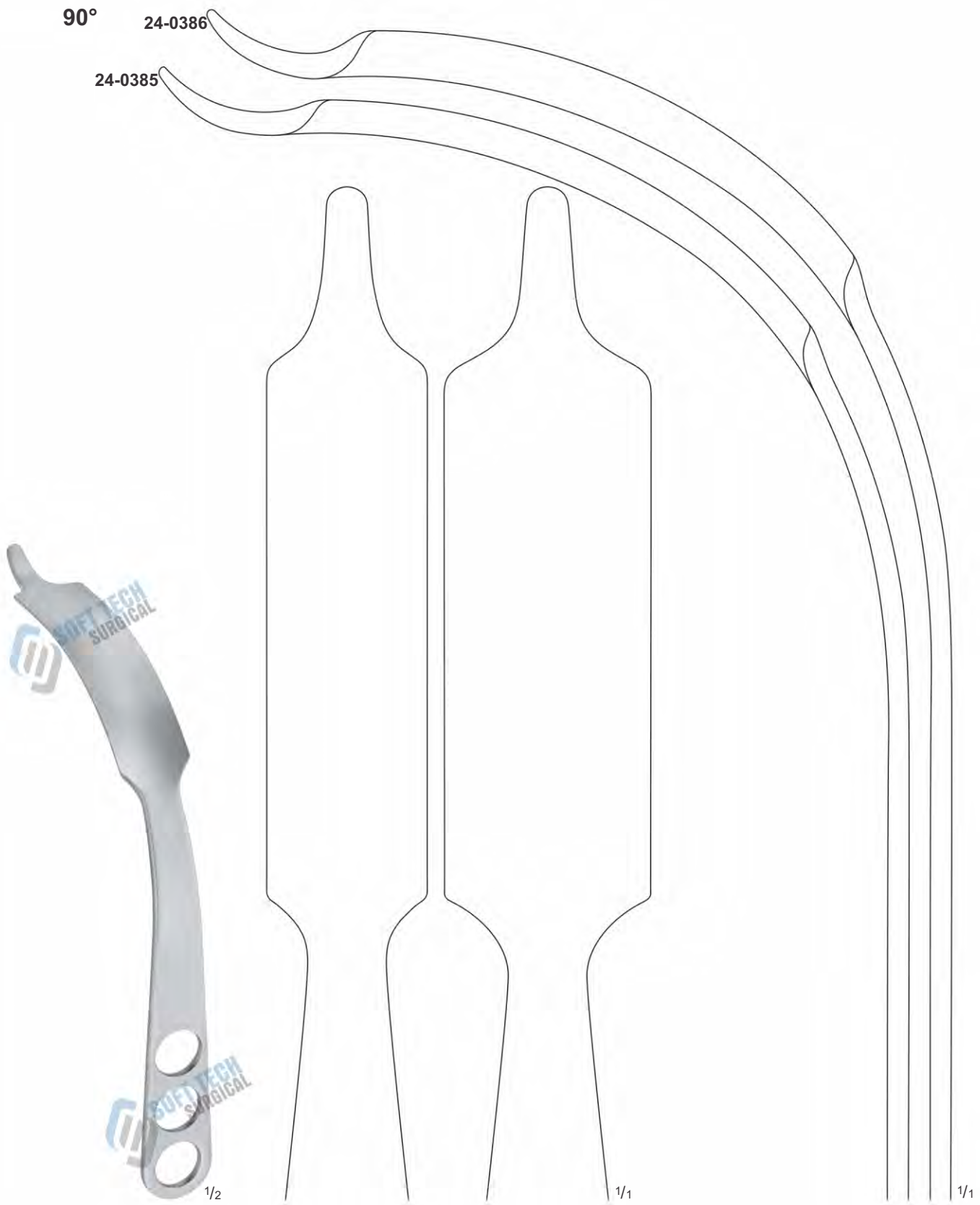

**MIOS HIP RETRACTOR**  
blunt tip  
240 mm

**24-0385**  
28 mm

**24-0386**  
40 mm

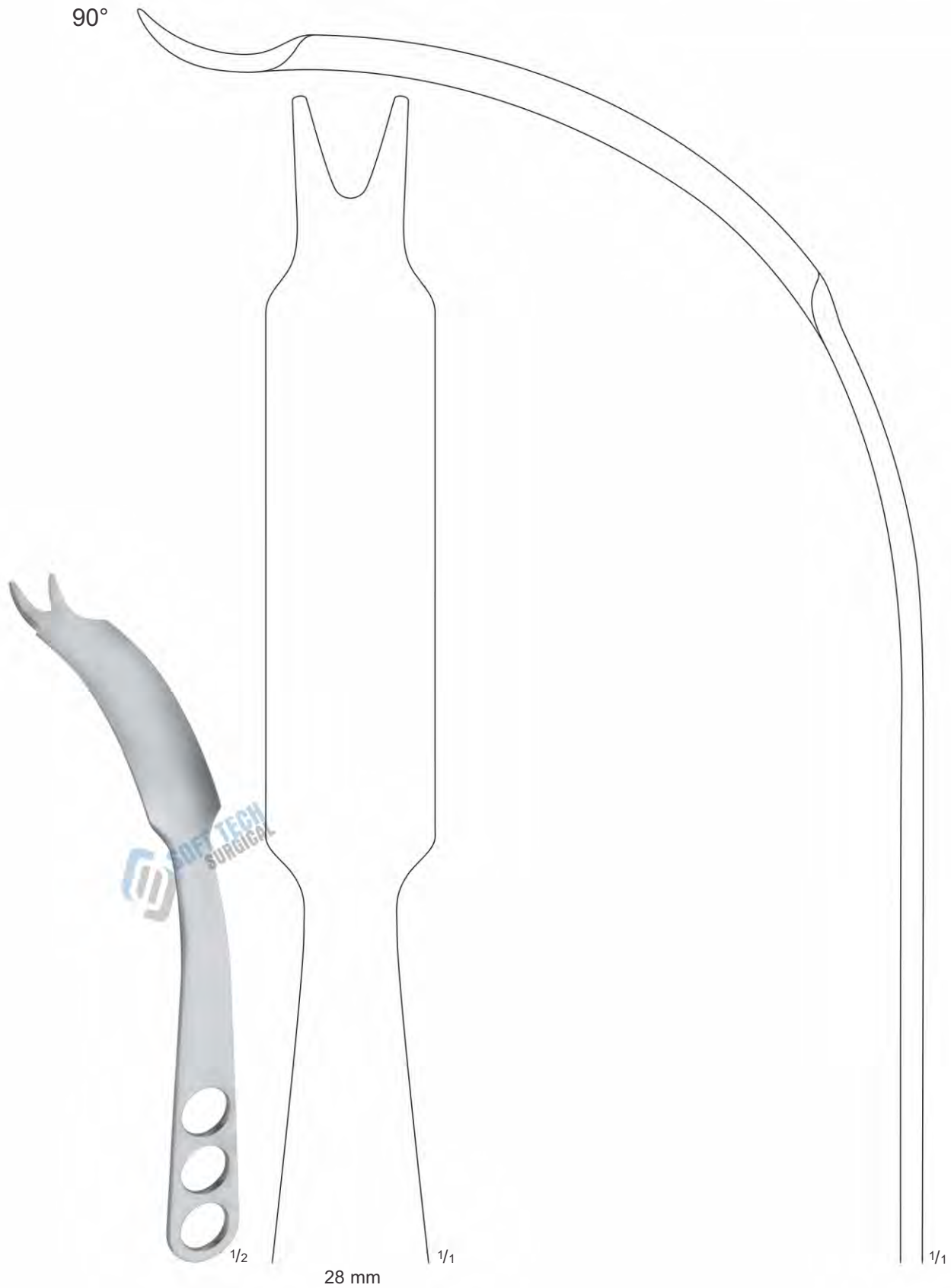

MIOS, HIP RETRACTOR  
24-0390  
V-tip  
240 mm

SOFT TECH Surgical, Manufacturer & Exporter of Quality Instruments

90°

24-0396

24-0395



1/2

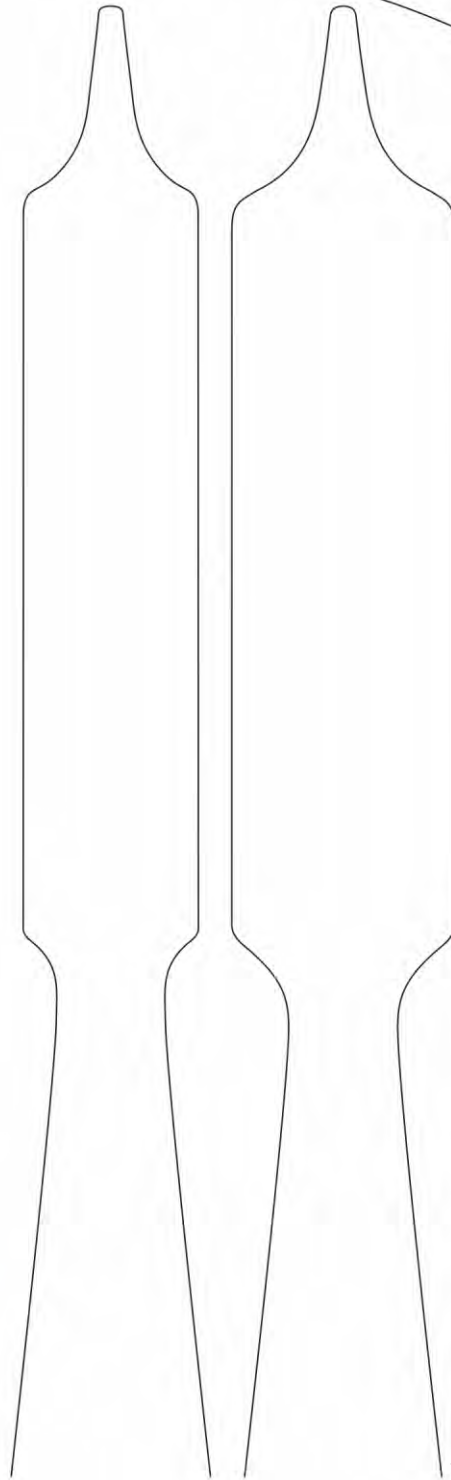

1/1

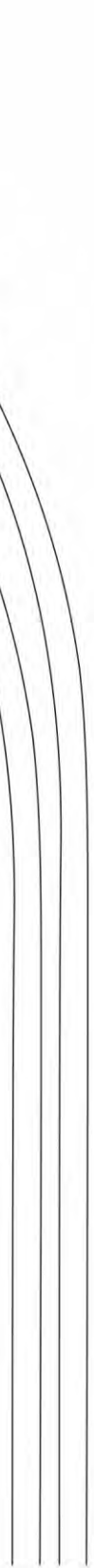

1/1

**MIOS, HIP RETRACTOR**  
short tip  
240 mm

**24-0395**  
22 mm

**24-0396**  
28 mm



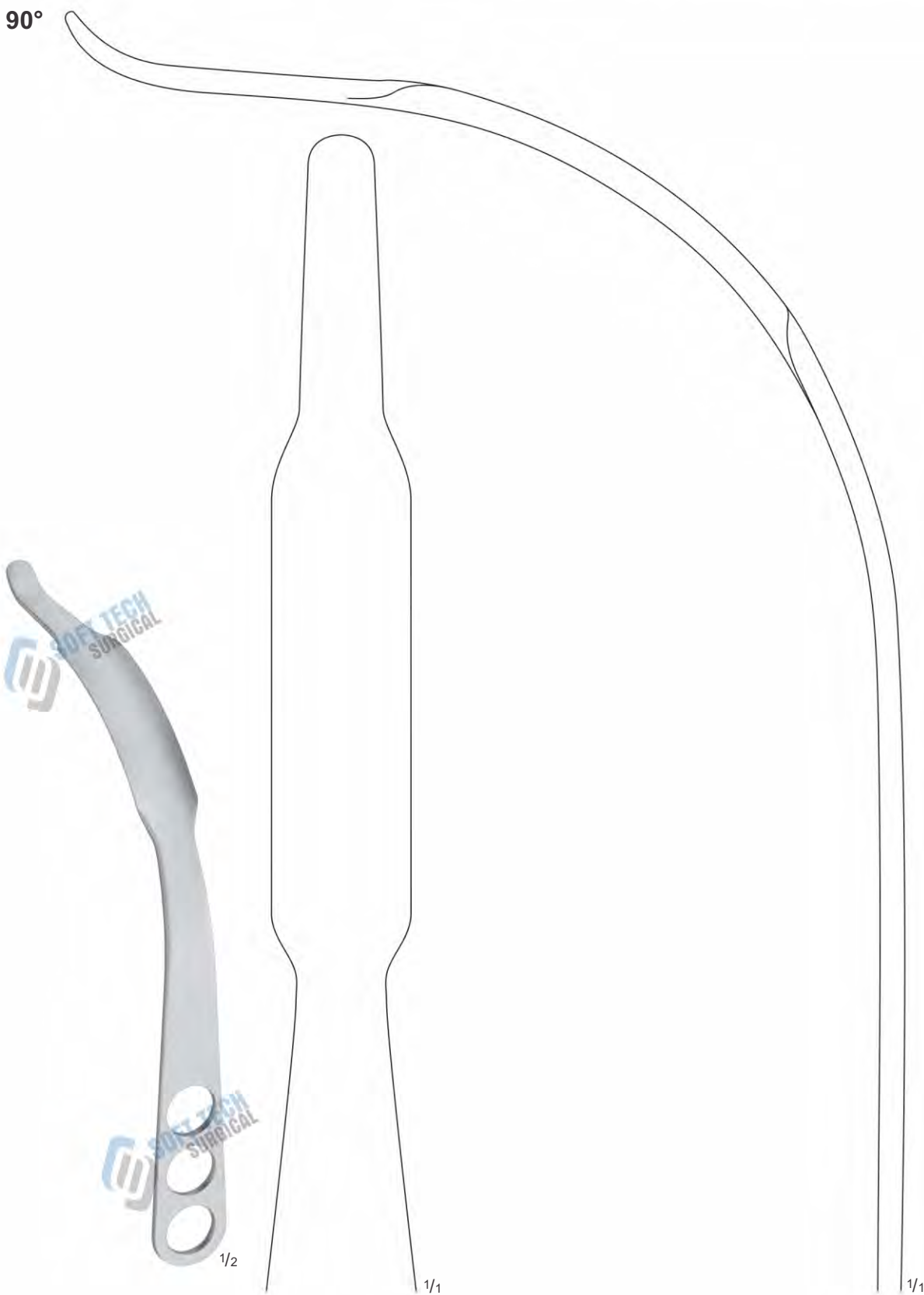

MIOS, FEMORAL NECK  
LEVER  
**24-0400**  
femoral neck tip  
240 mm

SOFT TECH Surgical, Manufacturer & Exporter of Quality Instruments

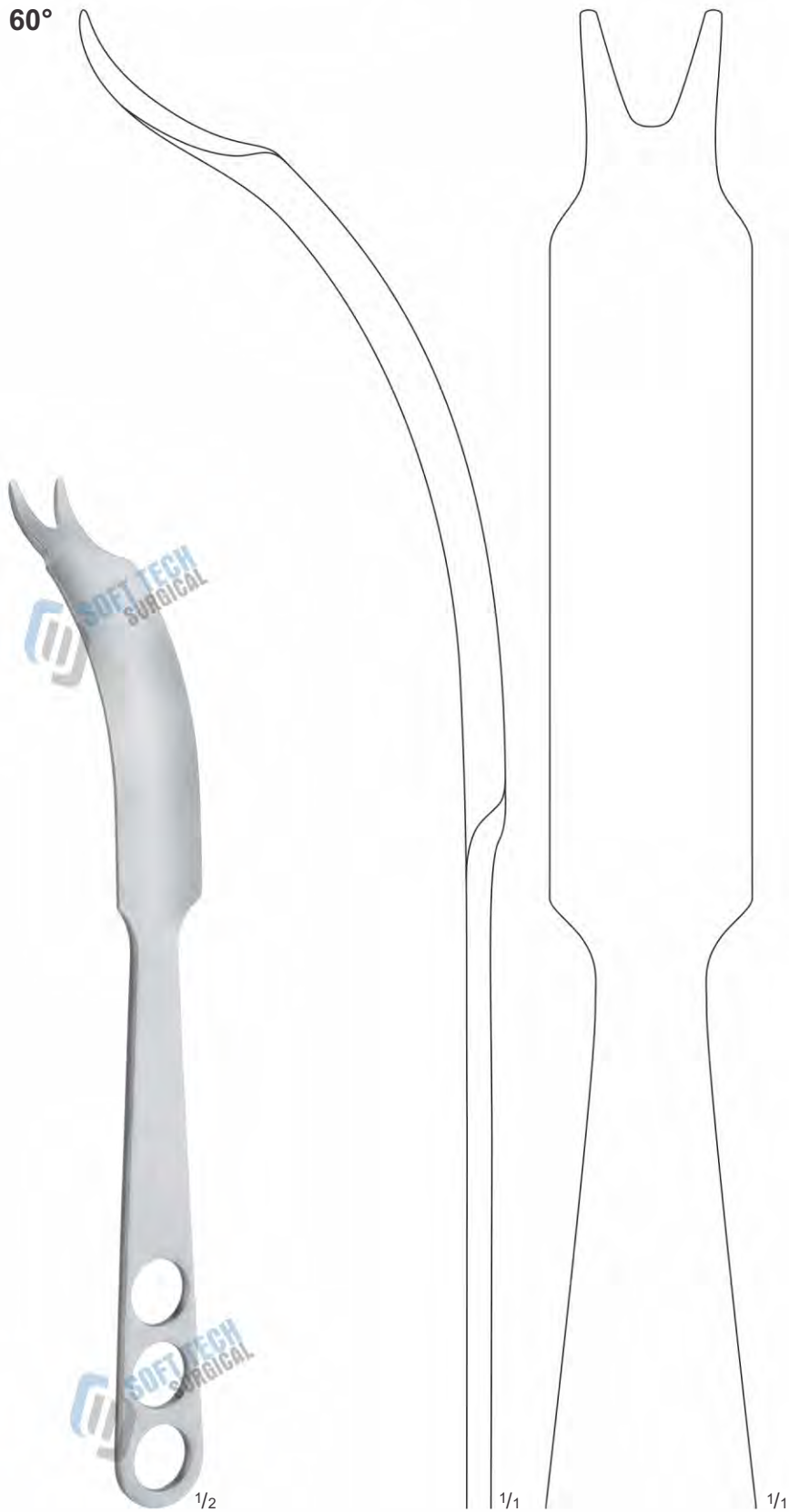

**MIOS HIP RETRACTOR**  
**24-0405**  
V-tip  
300 mm

45°

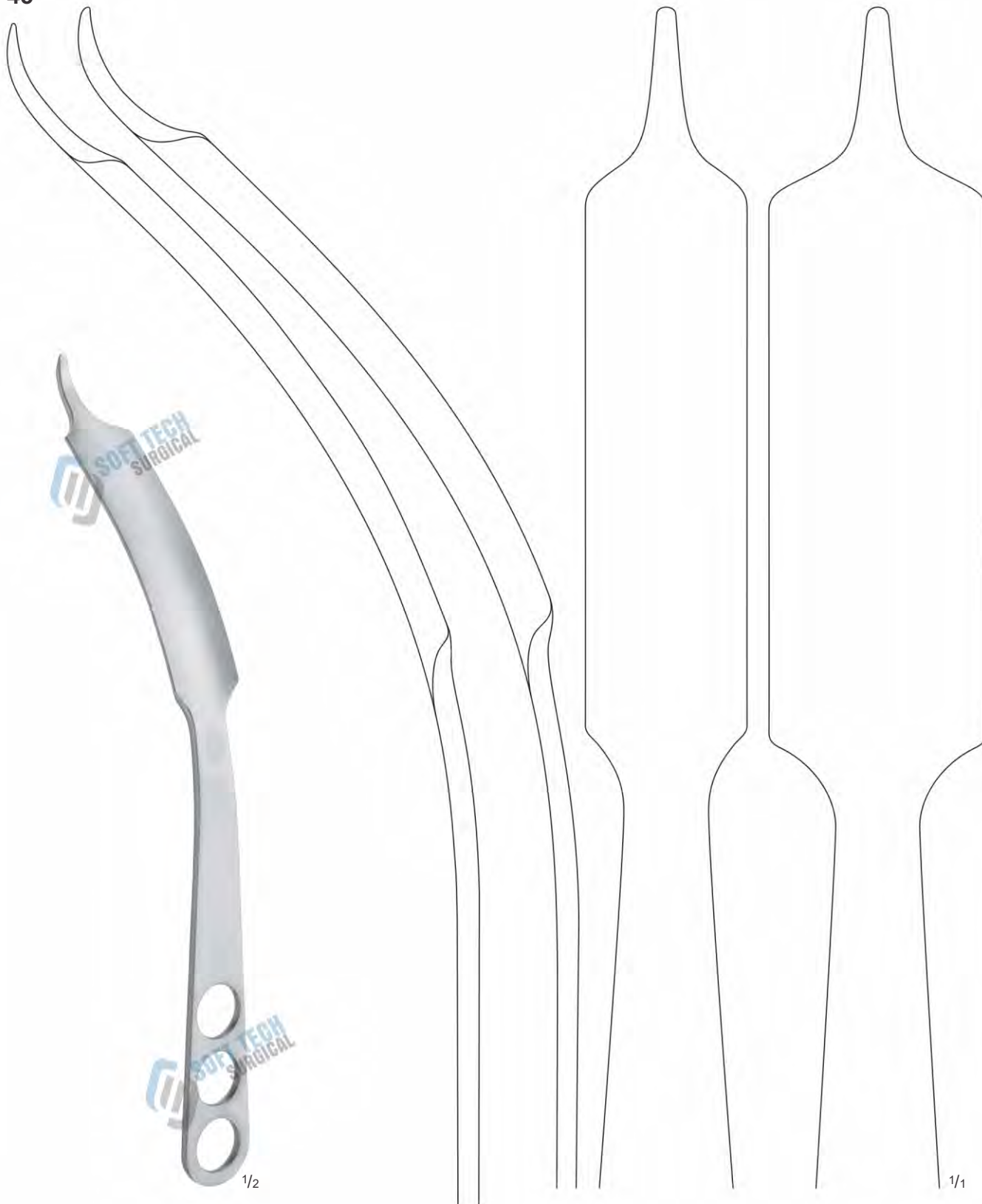

**MIOS HIP RETRACTOR**  
sharp tip  
300 mm

**24-0410**  
28 mm

**24-0411**  
40 mm

SOFT TECH Surgical, Manufacturer & Exporter of Quality Instruments

45°

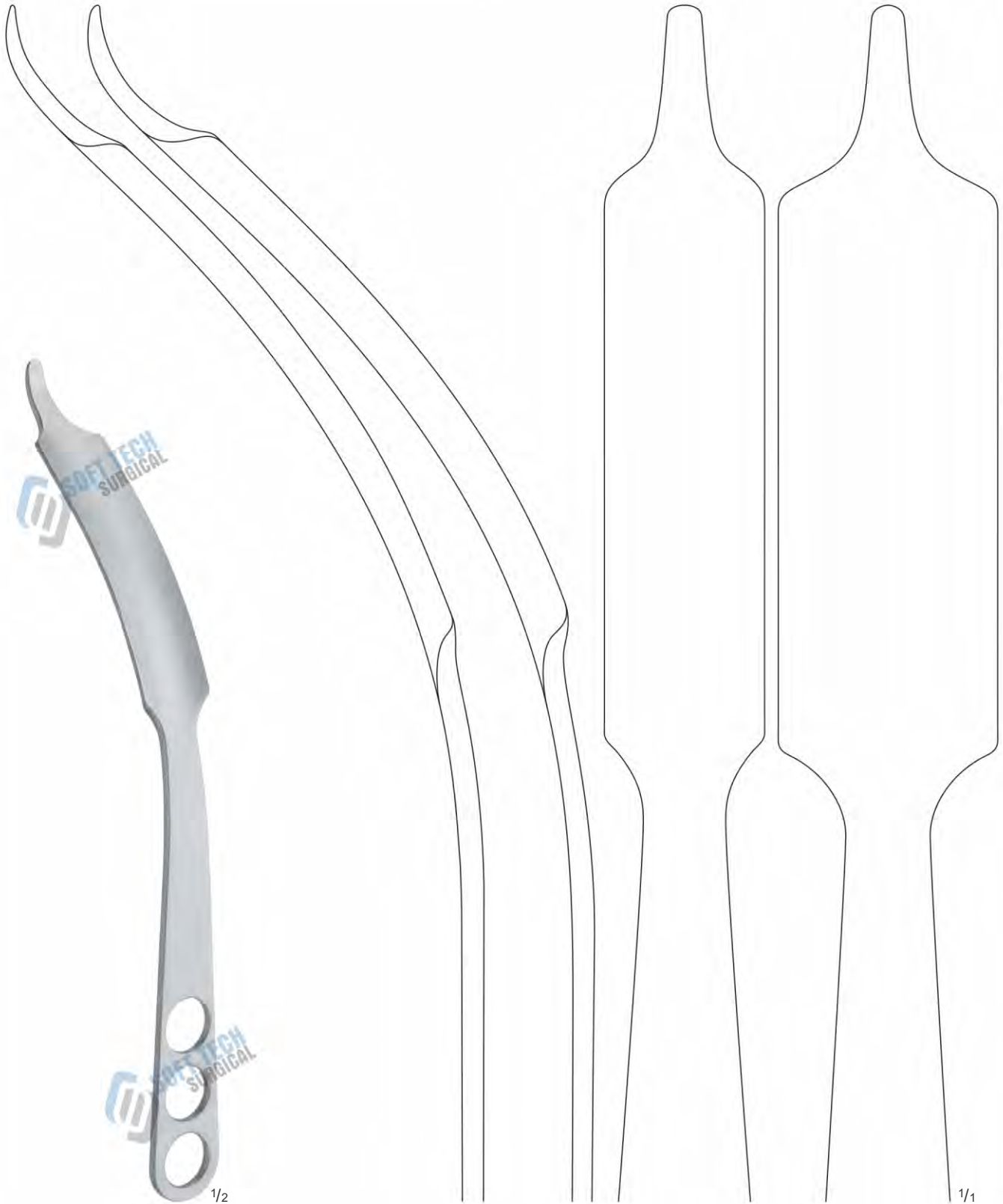

**MIOS HIP RETRACTOR**  
blunt tip  
300 mm

**24-0415**  
28 mm

**24-0416**  
40 mm



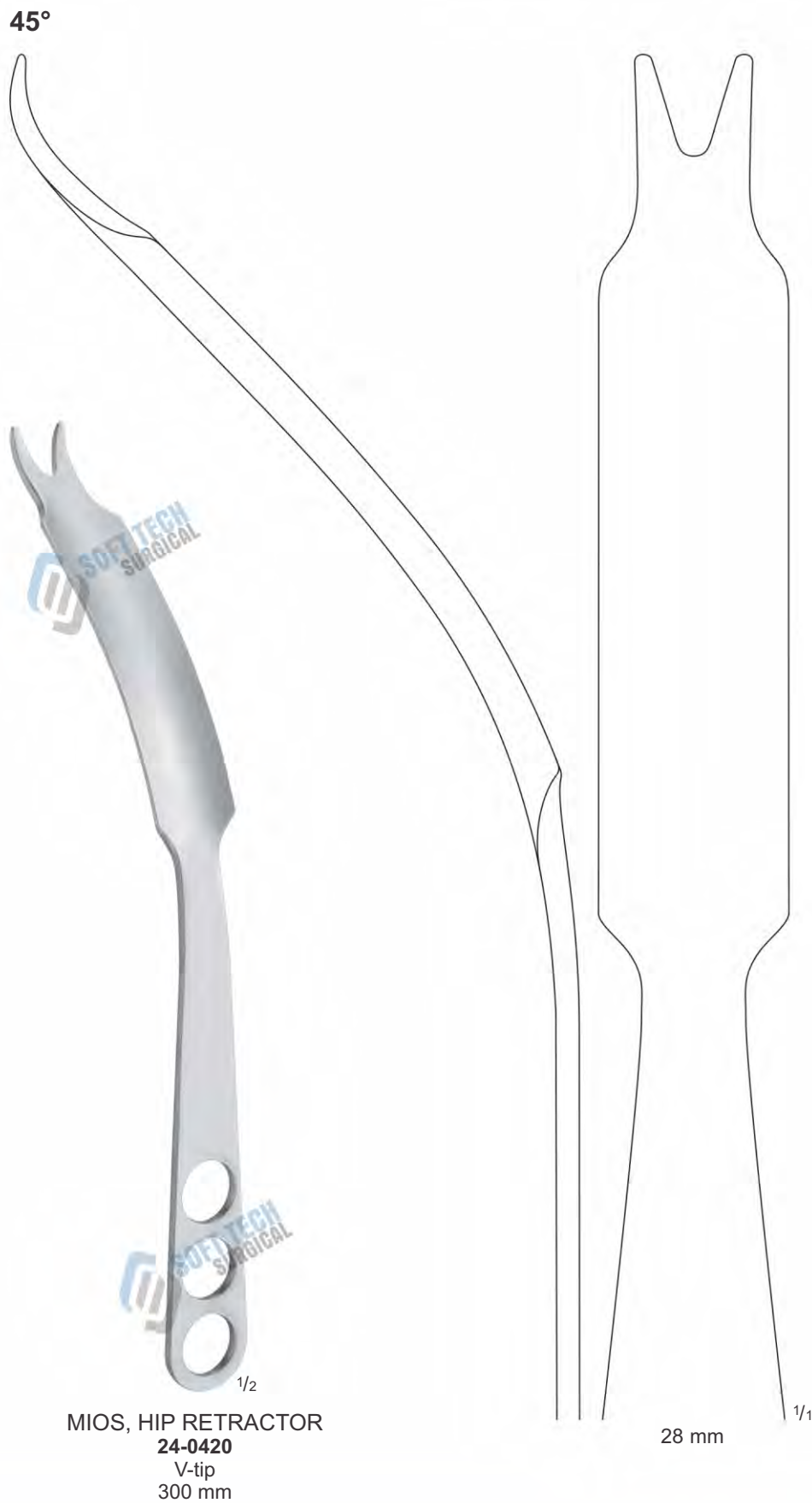

SOFT TECH Surgical, Manufacturer & Exporter of Quality Instruments

30°

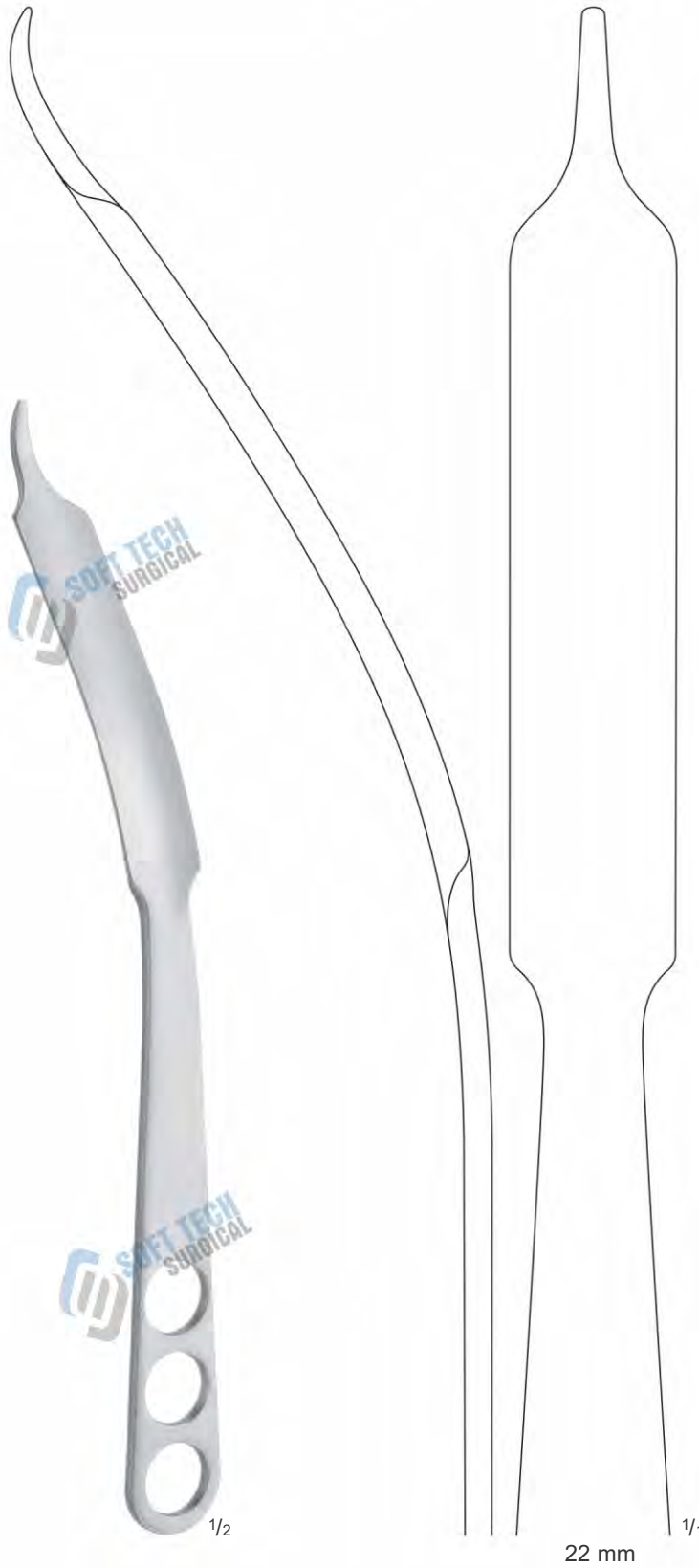

**MIOS, HIP RETRACTOR**  
**24-0425**  
sharp tip  
315 mm

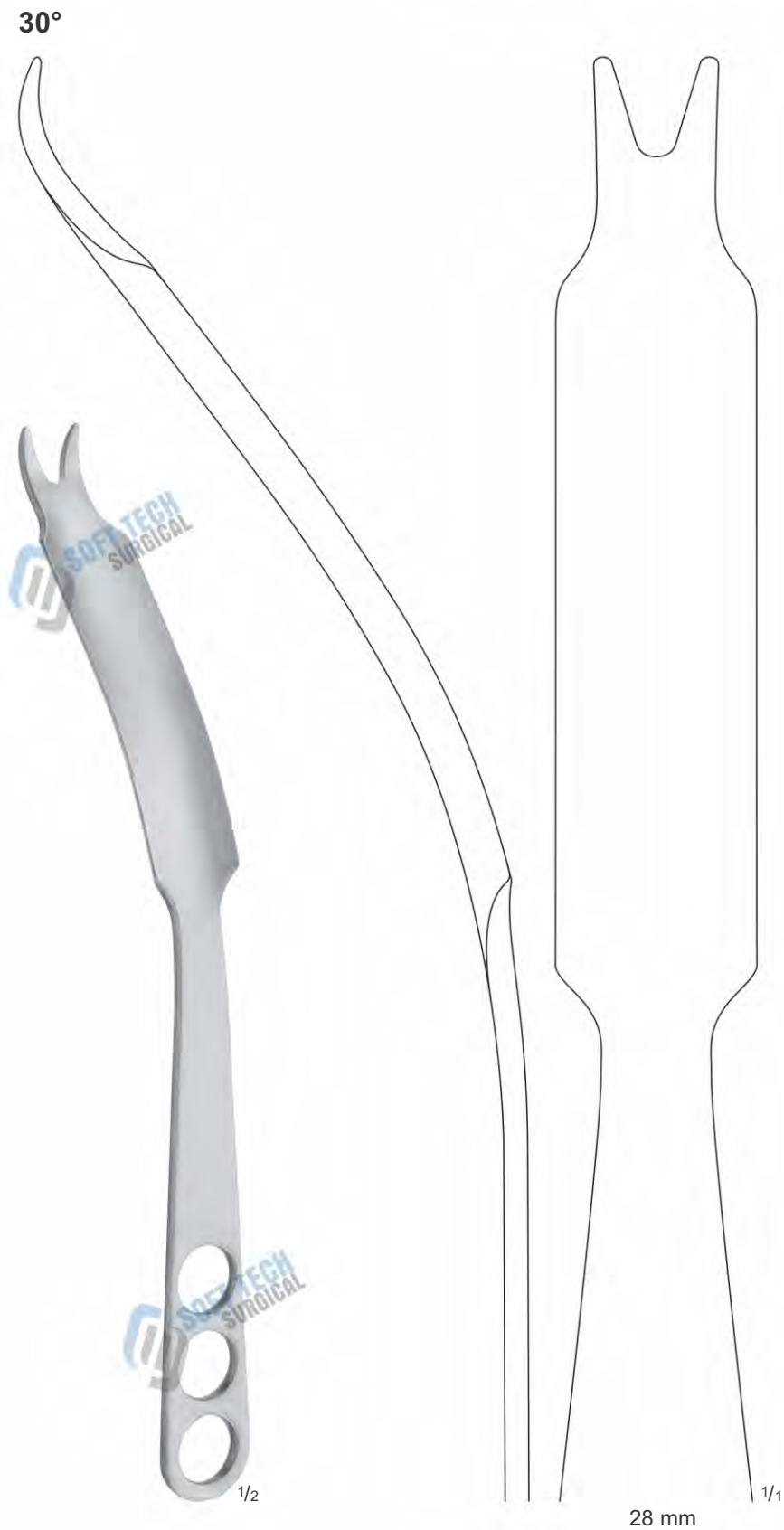

**MIOS, HIP RETRACTOR**  
**24-0430**  
V-tip  
315 mm

SOFT TECH Surgical, Manufacturer & Exporter of Quality Instruments

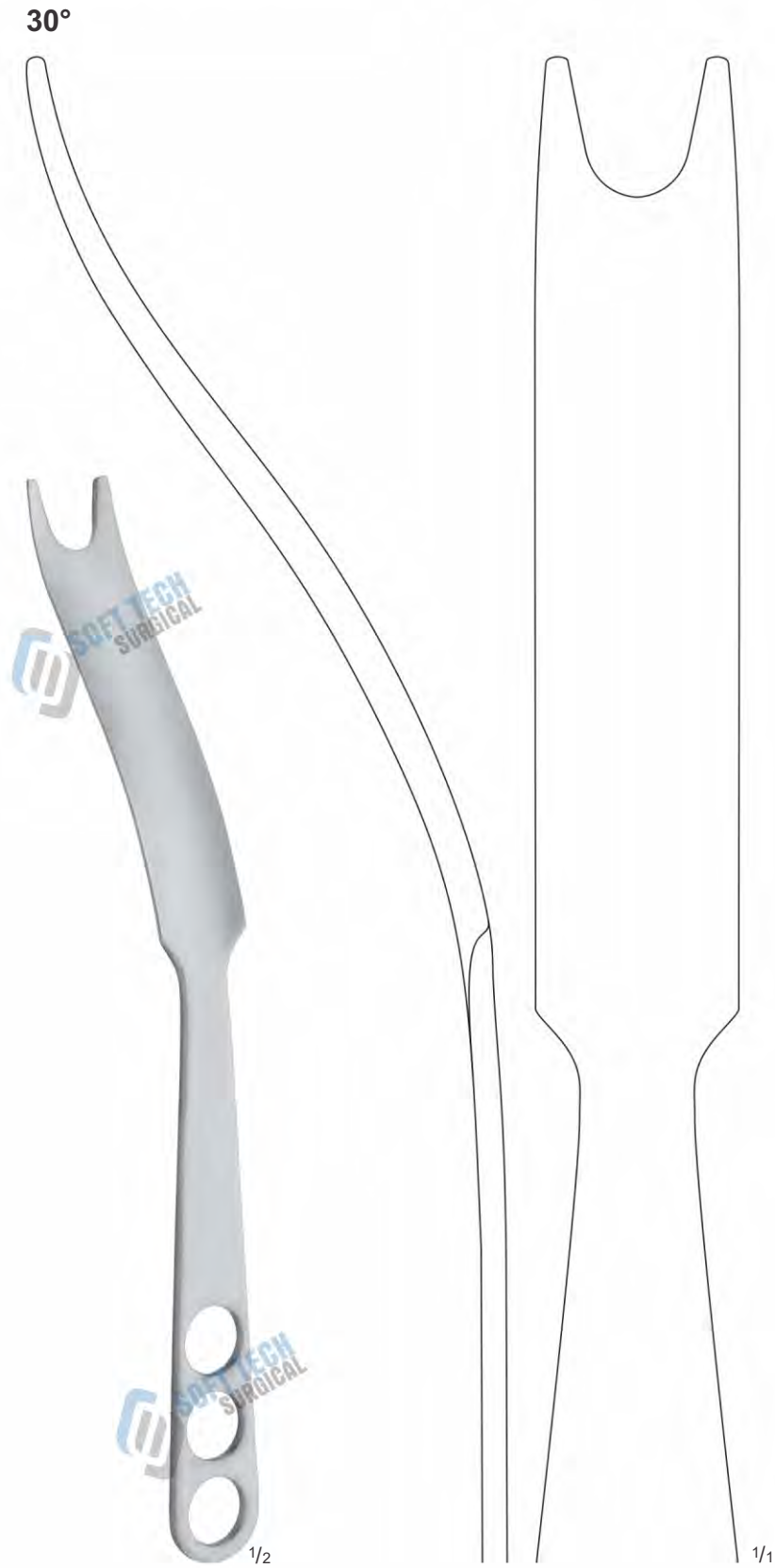

MIOS, HIP RETRACTOR  
**24-0435**  
U-tip  
315 mm





MIOS, FEMORAL NECK LEVER  
24-0440  
femoral neck tip  
315 mm

SOFT TECH Surgical, Manufacturer & Exporter of Quality Instruments



**PARTSCH BONE CURETTE**  
150 mm



**PARTSCH RASPATORY**  
**24-0450**  
145 mm



**MC KENTY PERIOSTEAL  
ELEVATOR**  
**24-0455**  
115 mm



**KÖNIG RASPATORY**  
**24-0460**  
155 mm



**TRELAT RASPATORY**  
24-0465  
150 mm



**RASPATORY**  
140 mm



**WILLIGER, RASPATORY**  
24-0475  
140 mm



**WILLIGER RASPATORY**  
160 mm



**WARD RASPATORY**  
24-0485  
170 mm



**JOSEPH RASPATORY**  
24-0490  
180 mm

SOFT TECH Surgical, Manufacturer & Exporter of Quality Instruments



**LEMPERT RASPATORY  
BLUNT**  
**24-0495**  
165 mm

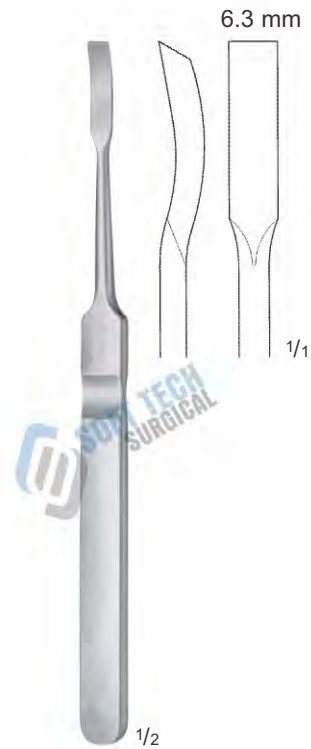

**LEMPERT RASPATORY  
SEMI-SHARP**  
**24-0500**  
185 mm



**ALLEN OSTEOPHYTE  
CHISEL AND SCRAPER**  
**24-0505**  
230 mm





**HALLE ELEVATOR BLUNT**  
**24-0510**  
180 mm



**FREER ELEVATOR BLUNT**  
**24-0515**  
190 mm



**FREER RASPATORY SHARP**  
**24-0520**  
190 mm



**SEWALL ELEVATOR BLUNT**  
**24-0525**  
200 mm

SOFT TECH Surgical, Manufacturer & Exporter of Quality Instruments



**KILIAN RASPATORY**  
SHARP / BLUN  
**24-0530**  
185 mm



**HOWARTH RASPATORY**  
SHARP / BLUNT  
**24-0535**  
215 mm



**MAC DONALD DISSECTOR**  
BLUNT / BLUNT  
**24-0540**  
190 mm

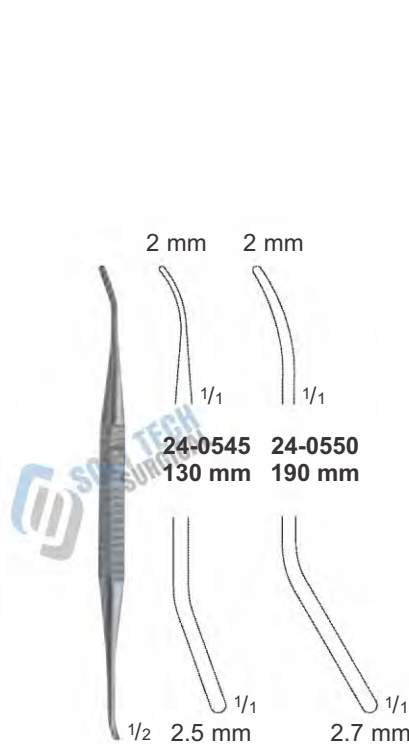

**WATSON-CHEYNE  
DISSECTOR**



**FREER RASPATORY**  
**24-0555**  
180 mm



**FREER RASPATORY**  
SHARP / BLUNT  
**24-0560**  
185 mm



**FREER YASARGIL DISSECTOR**  
SHARP / SHARP  
**24-0565**  
185 mm

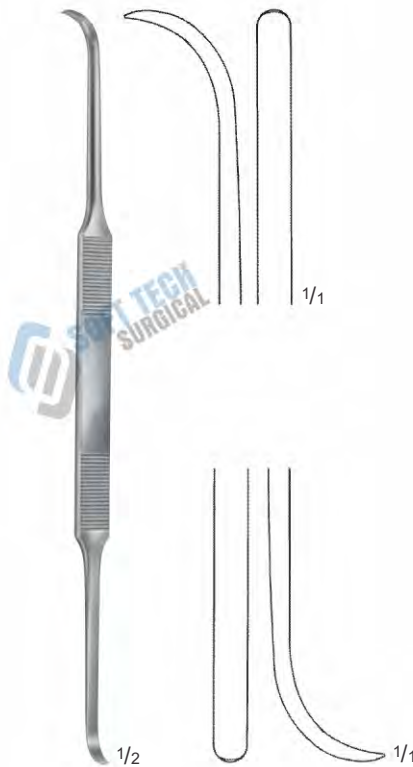

**COTTLE RASPATORY**  
SHARP / SHARP  
**24-0570**  
200 mm



**HILL RASPATORY**  
**24-0575**  
semi-sharp/blunt  
220 mm

SOFT TECH Surgical, Manufacturer & Exporter of Quality Instruments



**MEAD RASPATORY**  
**24-0580**  
sharp/sharp  
165 mm



**MOLT RASPATORY**  
**24-0585**  
sharp/sharp  
180 mm



**SYME RASPATORY**  
**24-0590**  
sharp  
185 mm



**ROBERTS RASPATORY**  
**24-0595**  
blunt  
185 mm

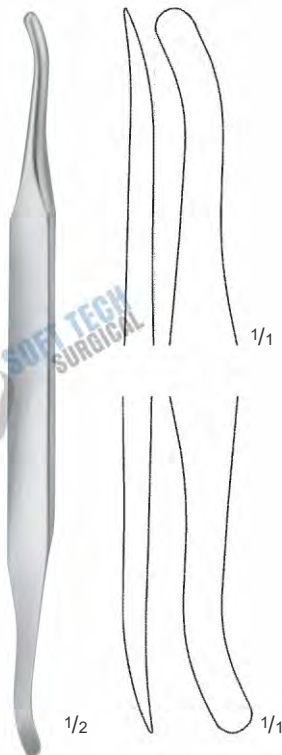

**SELDIN RASPATORY**  
**24-0600**  
195 mm



**SELDIN RASPATORY**  
**24-0605**  
195 mm

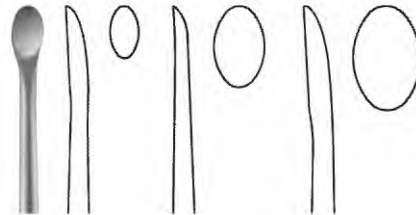

**24-0610**  
4 mm

**24-0611**  
7 mm

**24-0612**  
9 mm

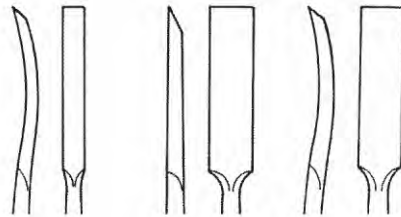

**24-0615**  
3 mm

**24-0616**  
6 mm

**24-0617**  
6 mm

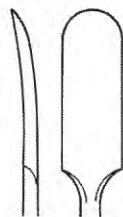

**24-0618**  
8 mm



**24-0619**  
6 mm  
90°



**MANNERFELT RASPATORY**  
155 mm



SOFT TECH Surgical, Manufacturer & Exporter of Quality Instruments

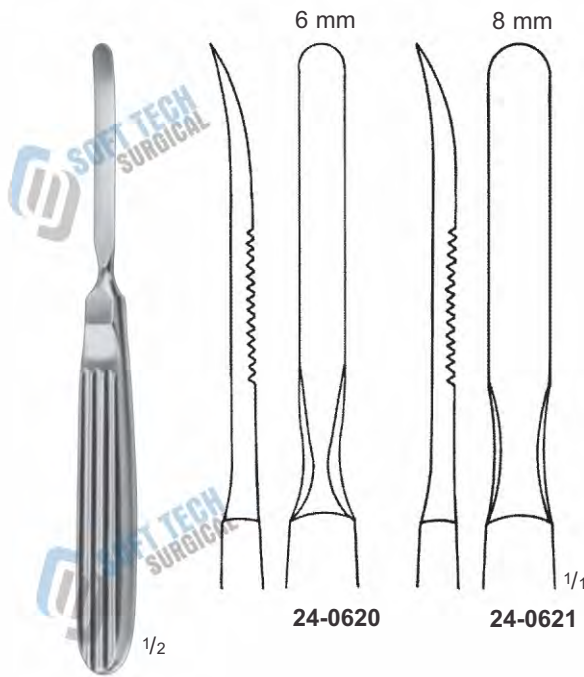

RASPATORY RASPATORY  
165 mm



ADSON RASPATORY  
24-0625  
165 mm



ADSON RASPATORY  
SHARP  
170 mm



MÜHLING RASPATORY  
170 mm

COTTLE RASPATORY  
24-0645  
195 mm



LANDOLT RASPATORY  
24-0650  
175 mm

CASPAR RASPATORY  
24-0655  
180 mm

CASPAR RASPATORY  
24-0660  
180 mm

RASPATORY  
24-0665  
170 mm

SOFT TECH Surgical, Manufacturer & Exporter of Quality Instruments



RASPATORY  
PEEK HANDLE  
24-0670  
190 mm



RASPATORY  
PEEK HANDLE  
24-0675  
185 mm



RASPATORY  
PEEK HANDLE  
24-0680  
190 mm

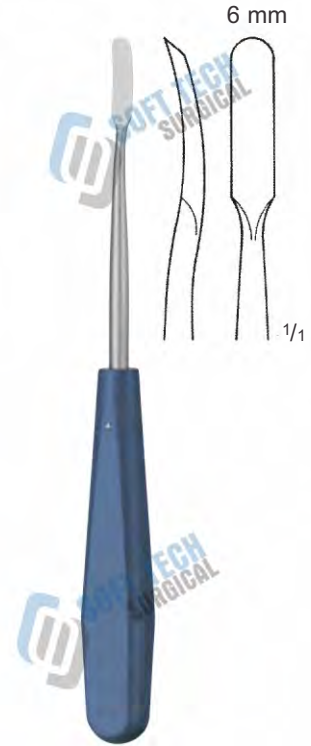

RASPATORY  
PEEK HANDLE  
24-0685  
190 mm

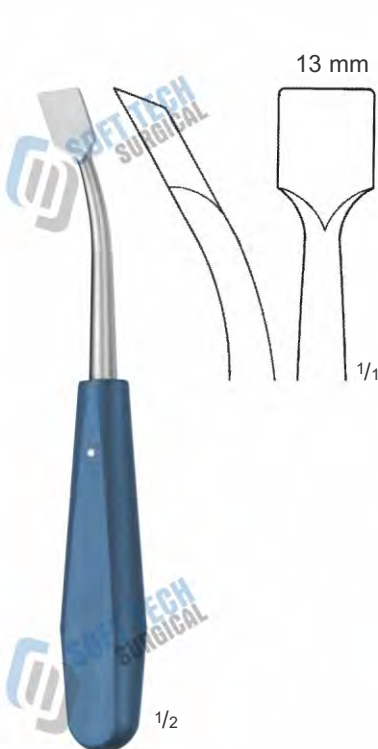

RASPATORY  
PEEK HANDLE  
24-0690  
175 mm



RASPATORY  
PEEK HANDLE  
24-0695  
190 mm



RASPATORY  
PEEK HANDLE  
24-0700  
180 mm



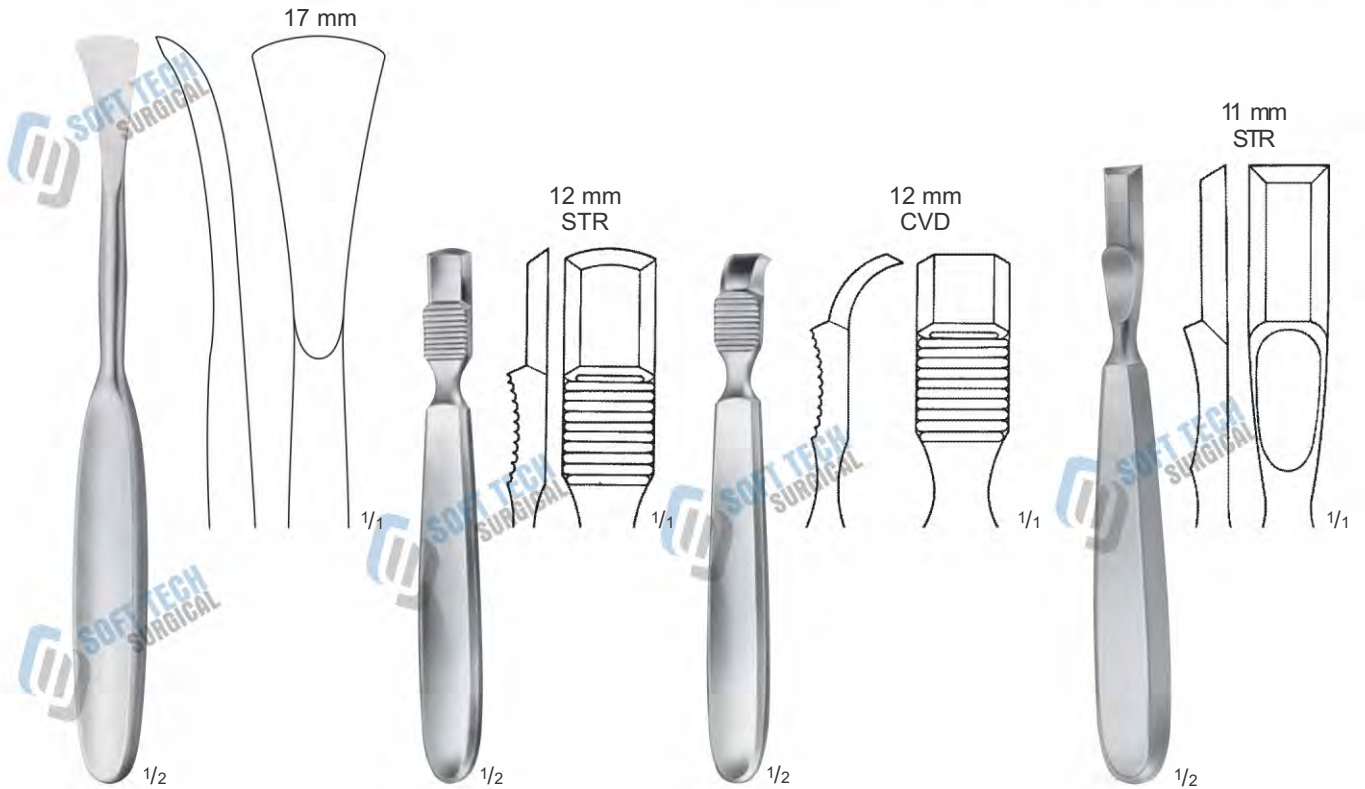

**LANGENBECK RASPATORY**  
**24-0705**  
190 mm

**FARABEUF RASPATORY**  
**24-0710**  
140 mm

**FARABEUF RASPATORY**  
**24-0715**  
140 mm

**FARABEUF- COLLIN, RASPATORY**  
**24-0720**  
160 mm

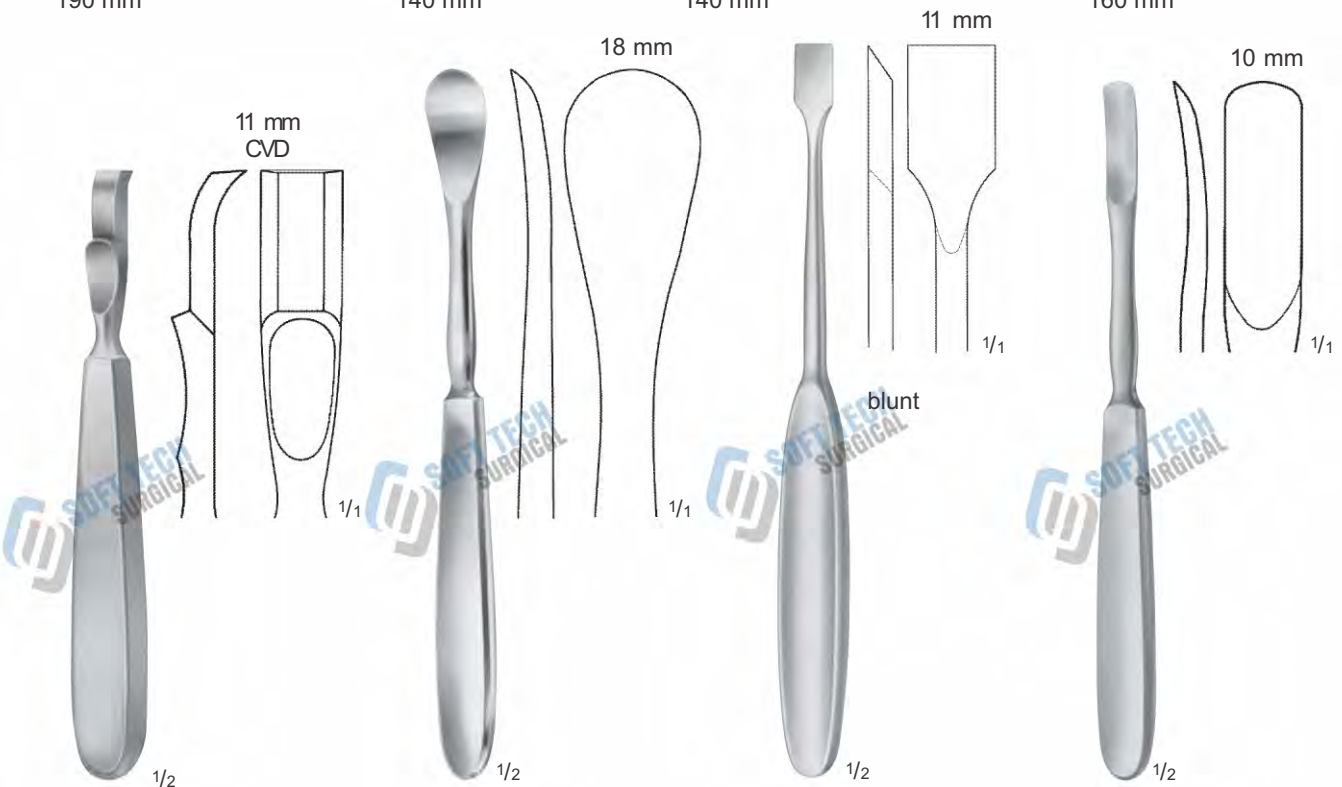

**FARABEUF- COLLIN RASPATORY**  
**24-0725**  
160 mm

**SEDILLOT RASPATORY**  
**24-0730**  
185 mm

**MC KISSOCK RASPATORY**  
**24-0735**  
195 mm

**KRÄMER RASPATORY**  
**24-0740**  
185 mm

SOFT TECH Surgical, Manufacturer & Exporter of Quality Instruments

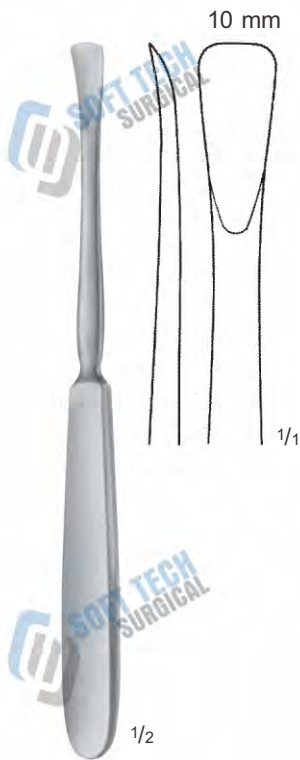

**KRÄMER  
RASPATORY**  
**24-0745**  
190 mm

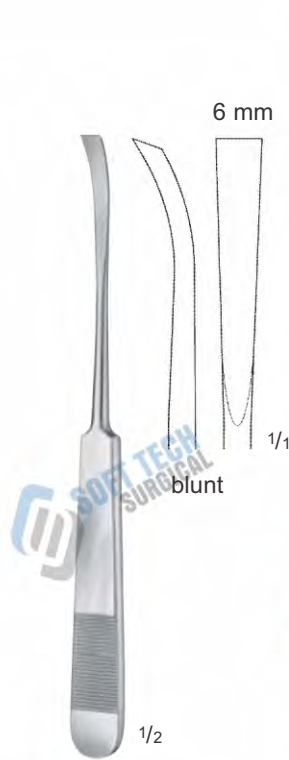

**PENNYBACKER  
RASPATORY**  
**24-0750**  
165 mm



**BÜCHS  
RASPATORY**  
**24-0755**  
190 mm



**JANSEN  
RASPATORY**  
**24-0760**  
165 mm

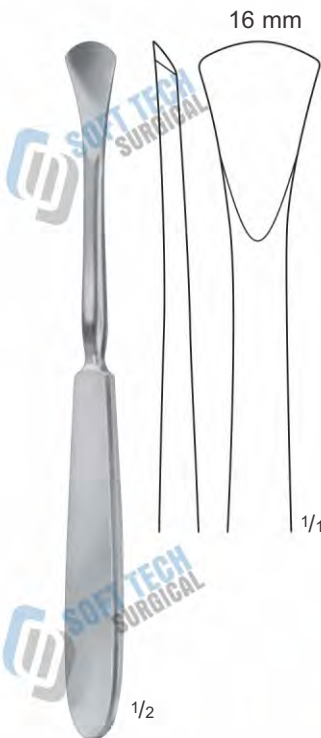

**LANGENBECK  
RASPATORY**  
**24-0765**  
190 mm

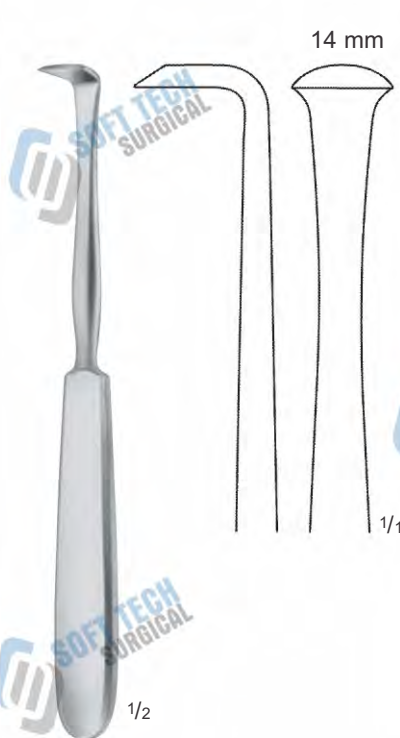

**LANGENBECK  
RASPATORY**  
**24-0770**  
180 mm



**KEY RASPATORY**

	Width	Length
<b>24-0775</b>	6 mm	180 mm
<b>24-0776</b>	10 mm	190 mm
<b>24-0777</b>	13 mm	190 mm
<b>24-0778</b>	19 mm	200 mm
<b>24-0779</b>	25 mm	210 mm



SOFT TECH Surgical, Manufacturer & Exporter of Quality Instruments



**SCHNEIDER RASPATORY**  
**24-0780**  
175 mm



**SCHNEIDER- SAUERBRUCH RASPATORY**  
**24-0785**  
190 mm

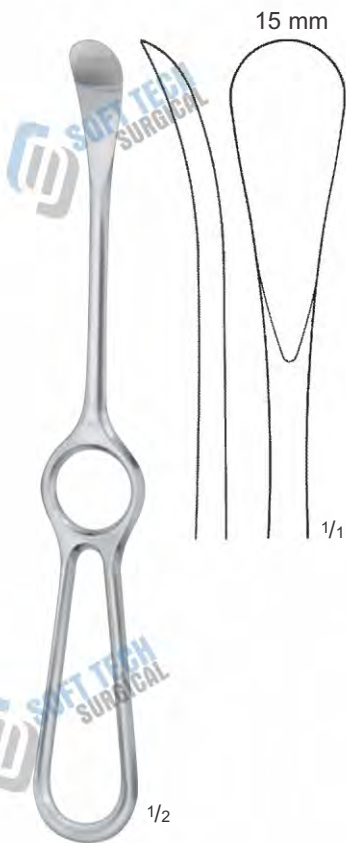

**SEDILLOT RASPATORY**  
**24-0790**  
215 mm

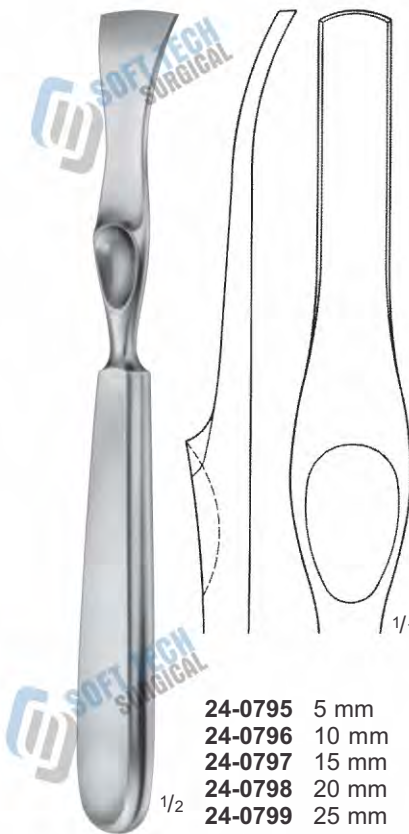

**LAMBOTTE RASPATORY**  
215 mm

- 24-0795** 5 mm
- 24-0796** 10 mm
- 24-0797** 15 mm
- 24-0798** 20 mm
- 24-0799** 25 mm



**MITCHELLS RASPATORY**  
**24-0805**  
210 mm

SOFT TECH Surgical, Manufacturer & Exporter of Quality Instruments

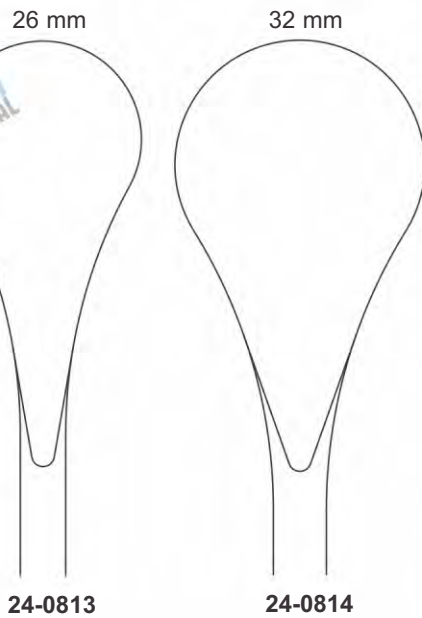
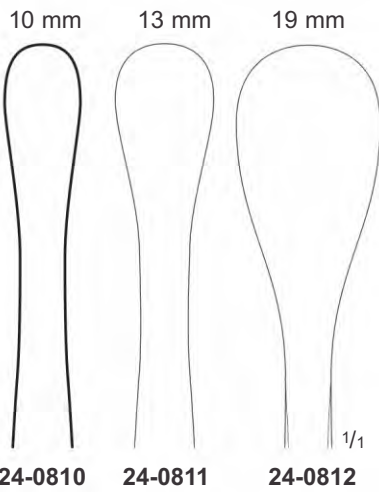

**COBB ELEVATOR**  
280 mm

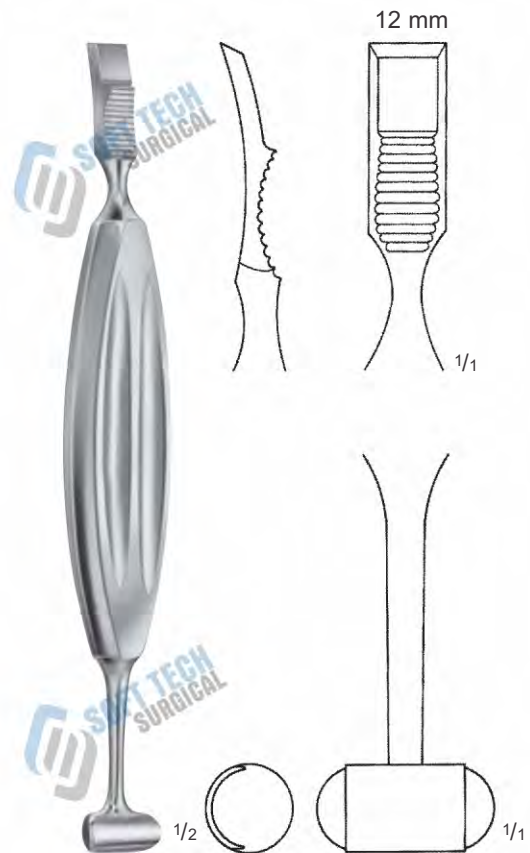

**ALEXANDER RASPATORY**  
24-0820  
210 mm



SEMB RASPATORY

SOFT TECH Surgical, Manufacturer & Exporter of Quality Instruments



**DOYEN RASPATORY**  
for children  
175 mm

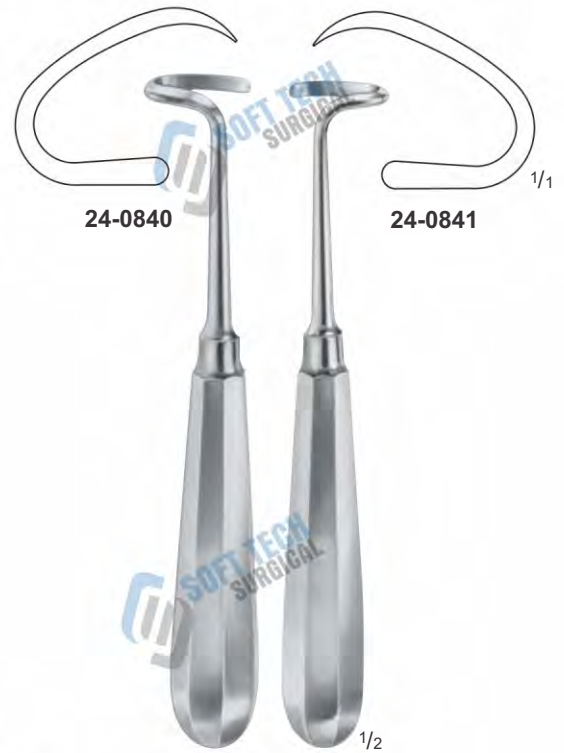

**DOYEN RASPATORY**  
for adults  
175 mm



**DOYEN RASPATORY**  
240 mm



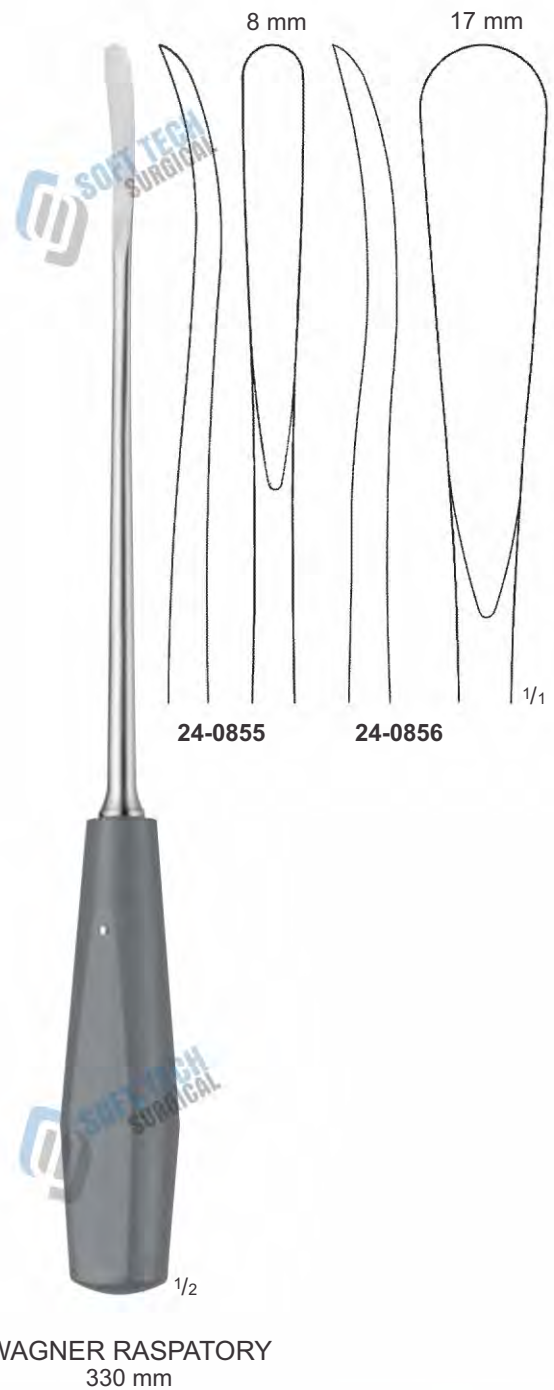



SOFT TECH Surgical, Manufacturer & Exporter of Quality Instruments



SOFT TECH Surgical, Manufacturer & Exporter of Quality Instruments

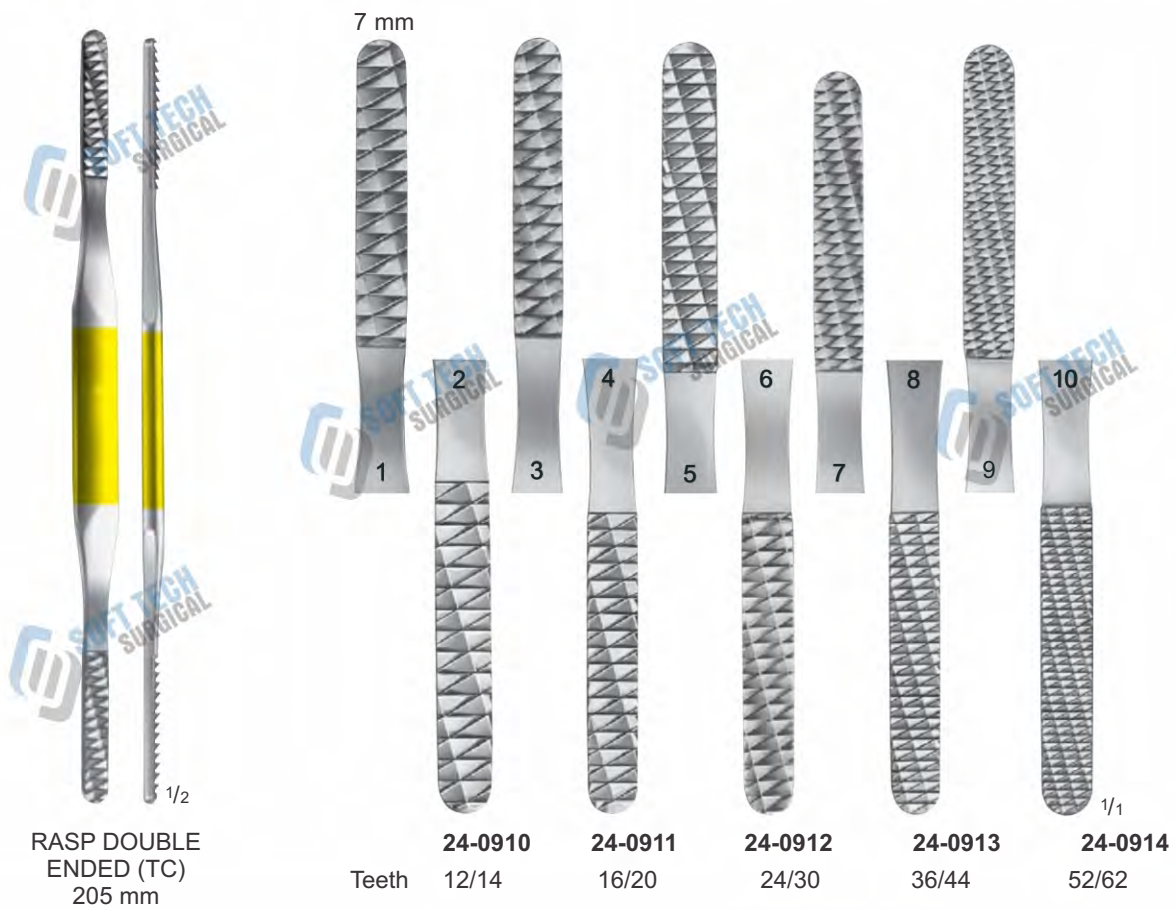



SOFT TECH Surgical, Manufacturer & Exporter of Quality Instruments

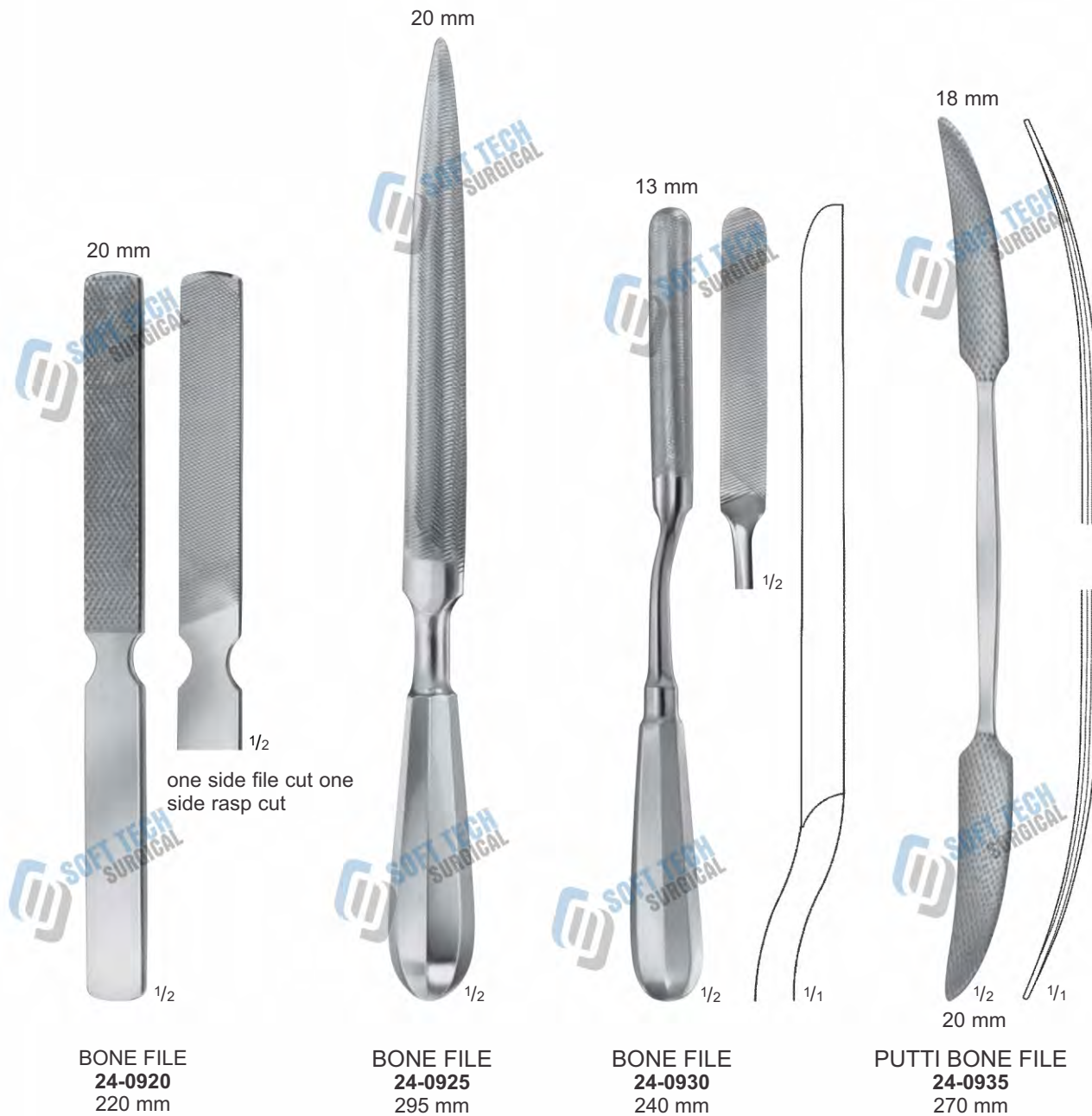

SOFT TECH Surgical, Manufacturer & Exporter of Quality Instruments

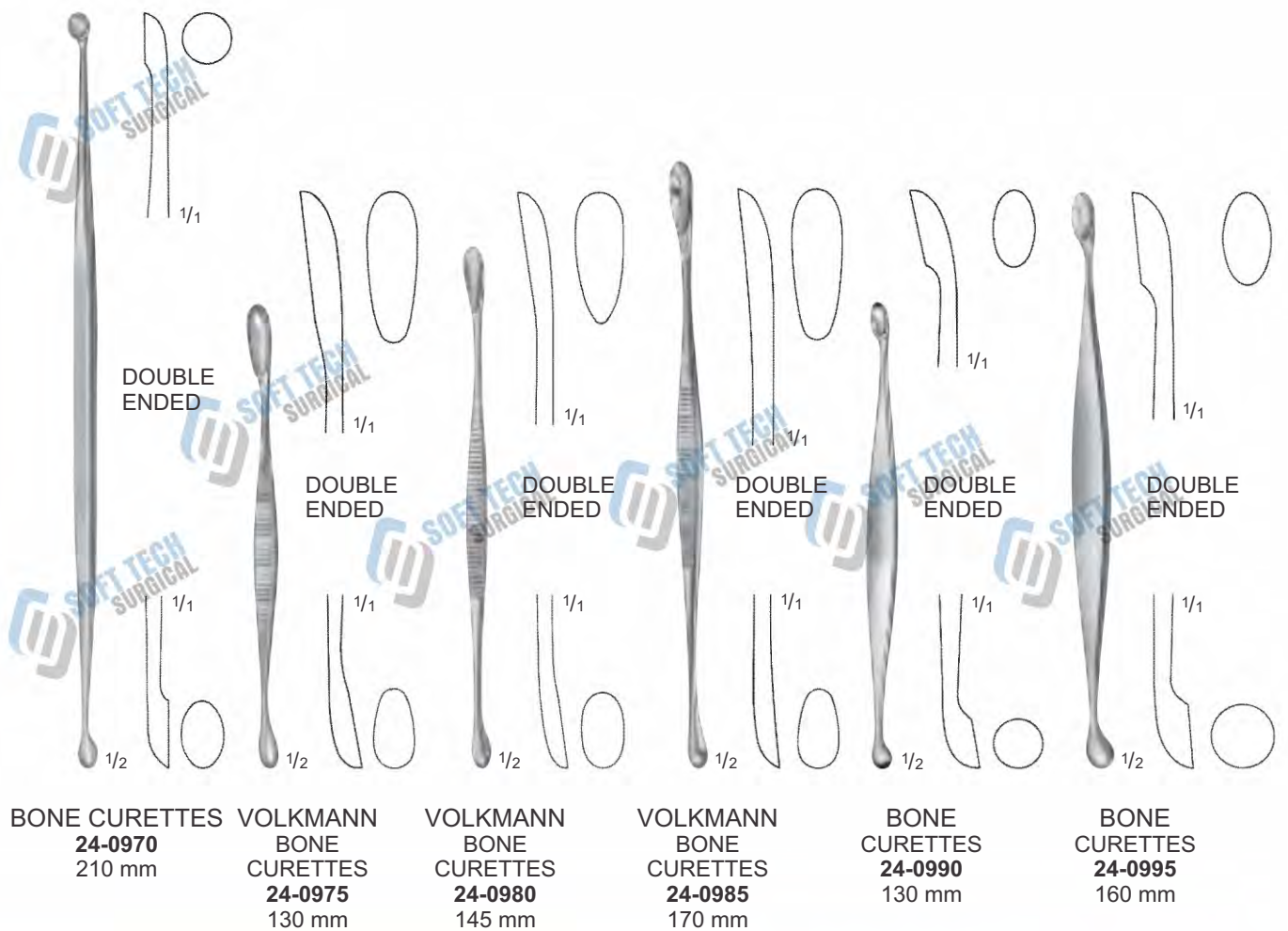
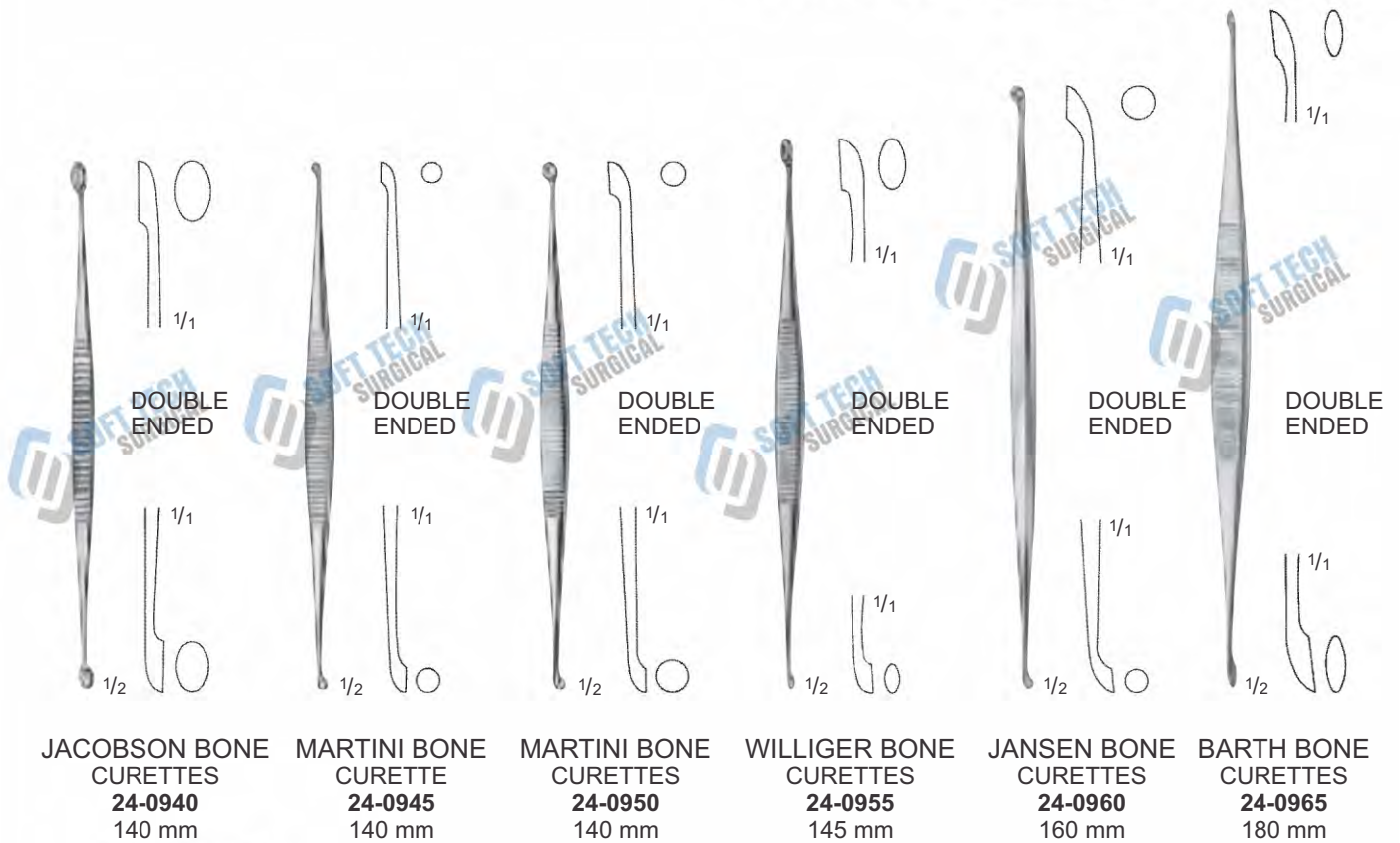

SOFT TECH Surgical, Manufacturer & Exporter of Quality Instruments

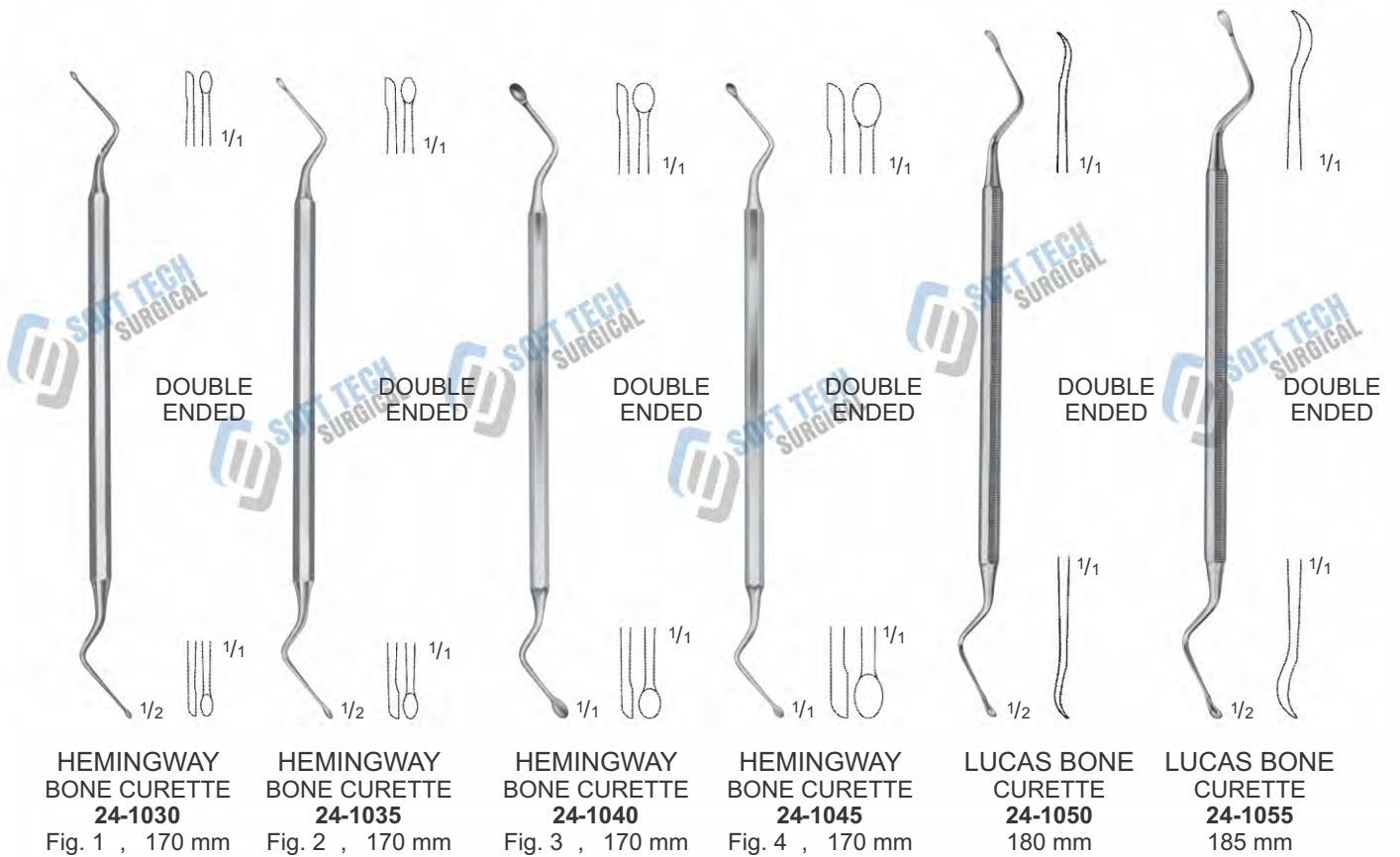
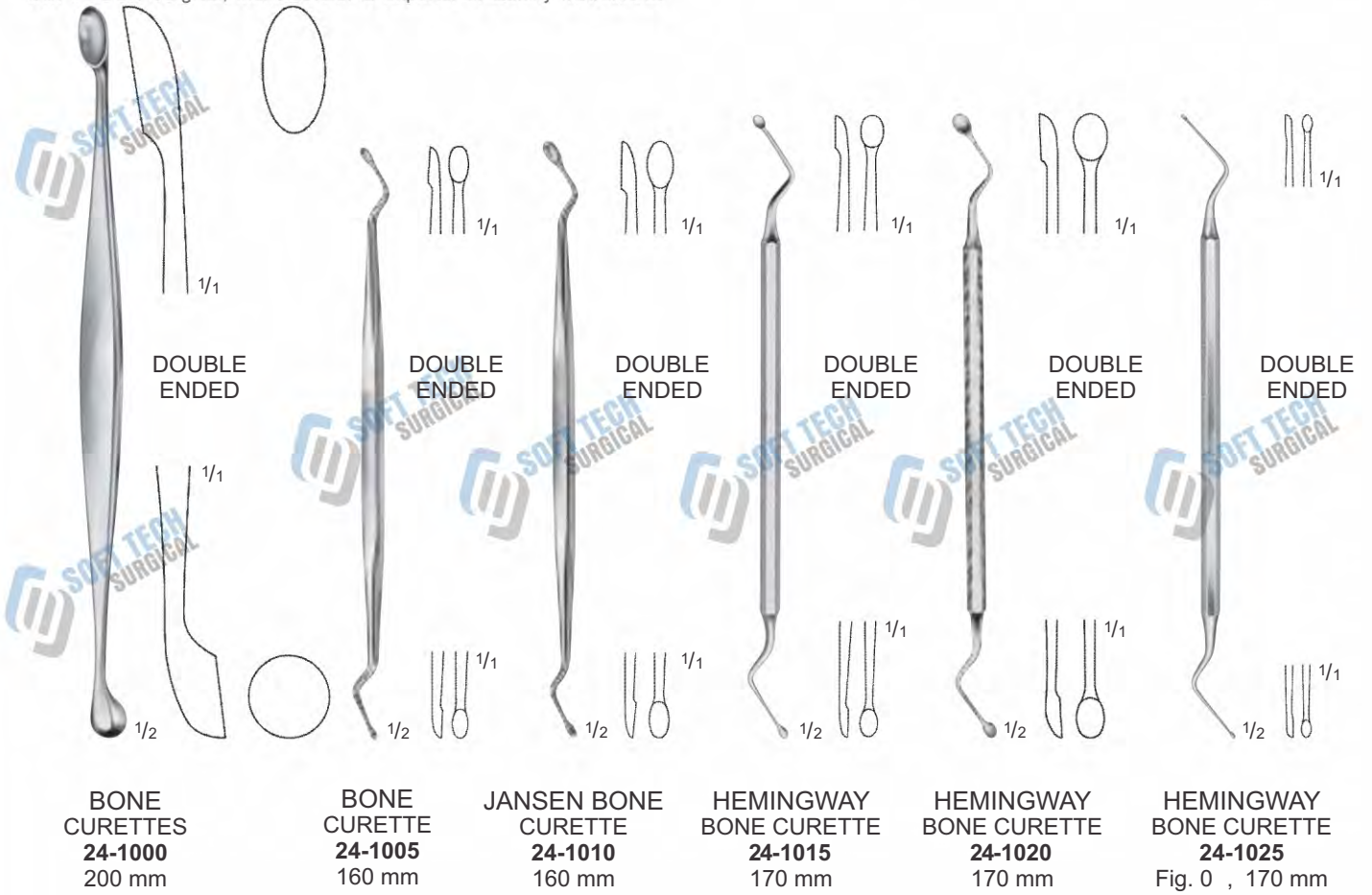





**KERPEL BONE CURETTE**  
145 mm



**KERPEL BONE CURETTE**  
145 mm



**UFFENDORDE BONE CURETTES**  
**24-1070**  
170 mm

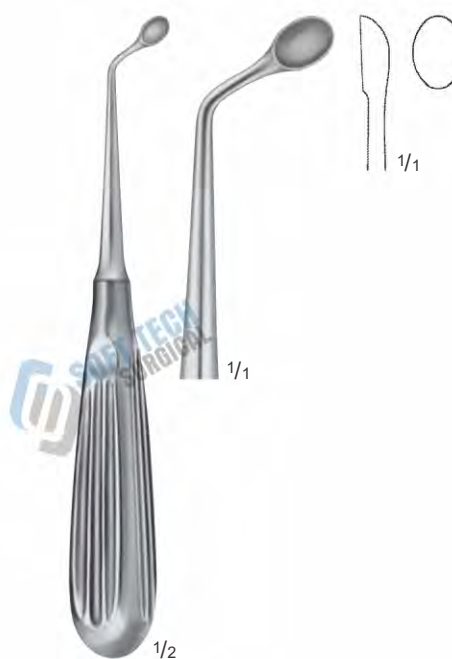

**UFFENDORDE BONE CURETTES**  
**24-1075**  
170 mm

SOFT TECH Surgical, Manufacturer & Exporter of Quality Instruments

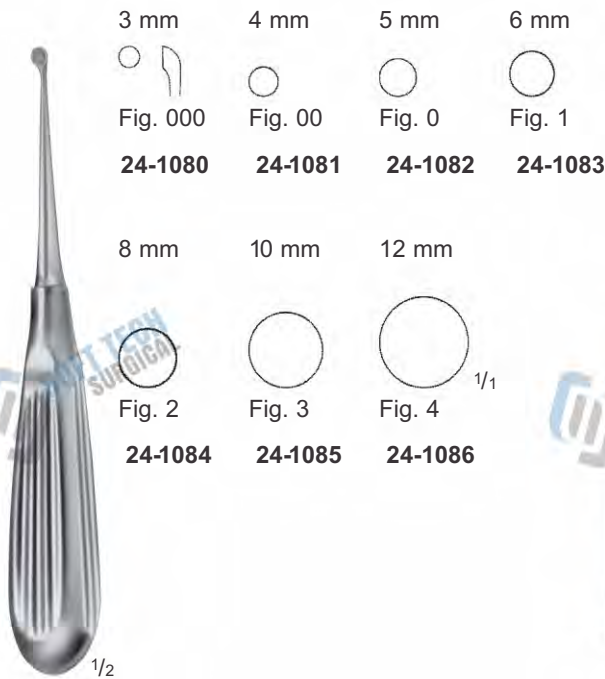

BRUNS BONE CURETTES  
165 mm

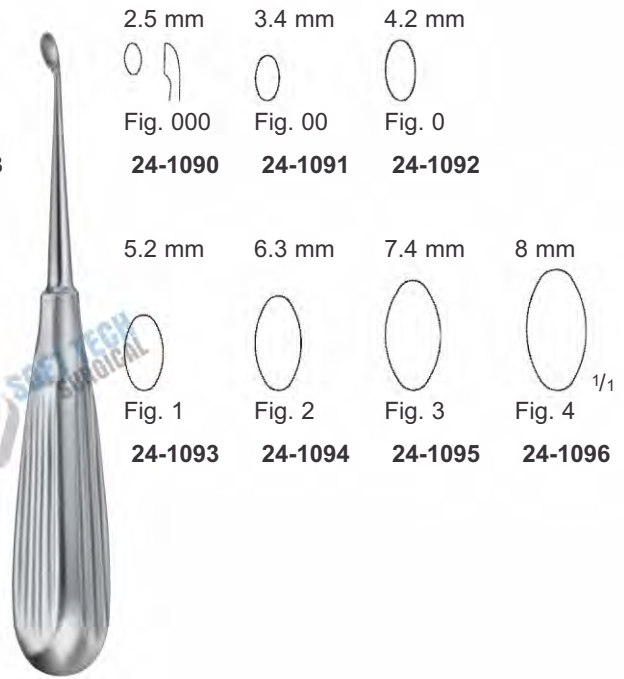

SCHUDE BONE CURETTES  
170 mm

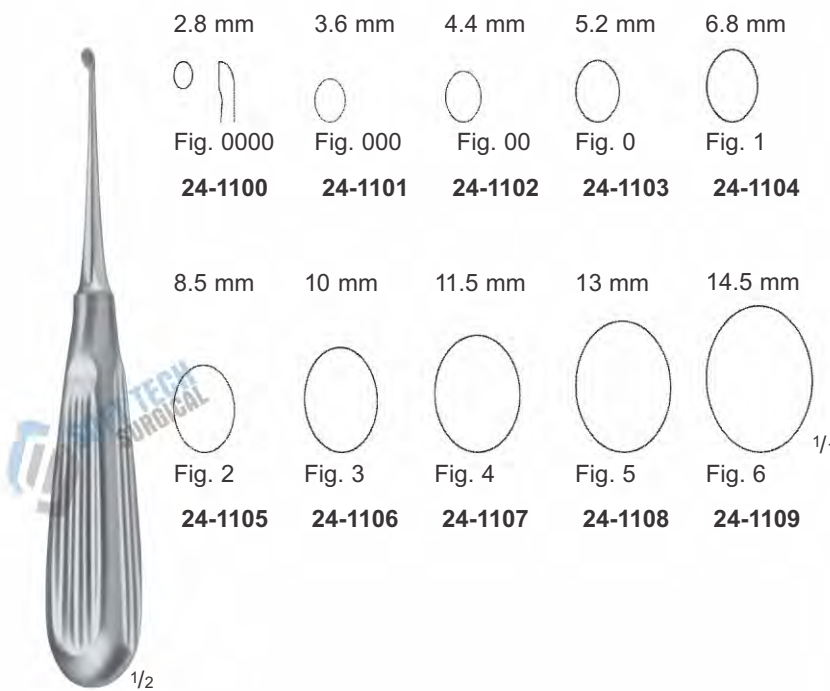

VOLKMANN BONE CURETTES  
170 mm

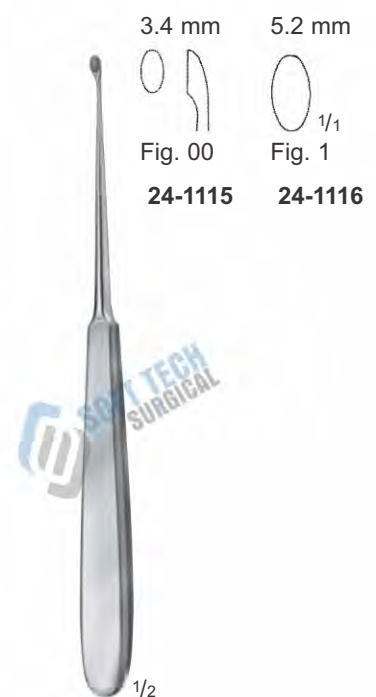

WILLIGER BONE CURETTES  
170 mm



LEMPERT BONE  
CURETTES  
215 mm

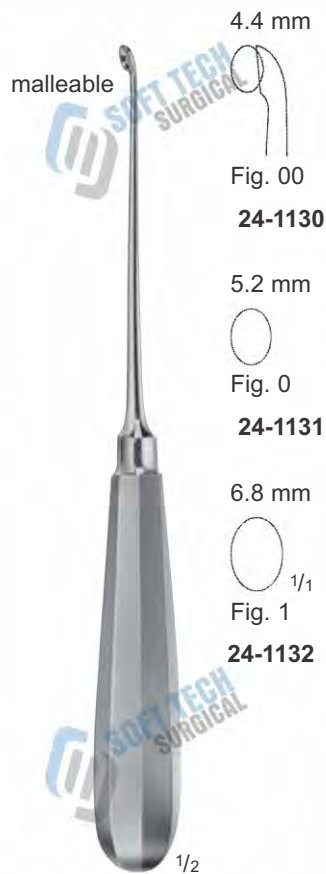

HALLE BONE  
CURETTES  
215 mm



DAUBENSPECK BONE  
CURETTES  
200 mm

SOFT TECH Surgical, Manufacturer & Exporter of Quality Instruments

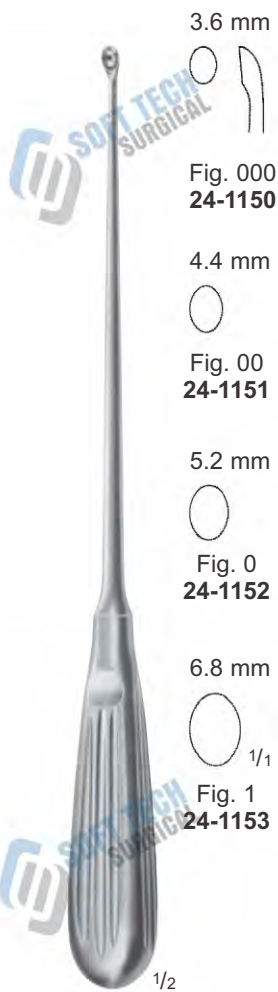

**BONE CURETTES**  
250 mm



**BONE CURETTES**  
250 mm



**BUSHE BONE CURETTES**  
250 mm



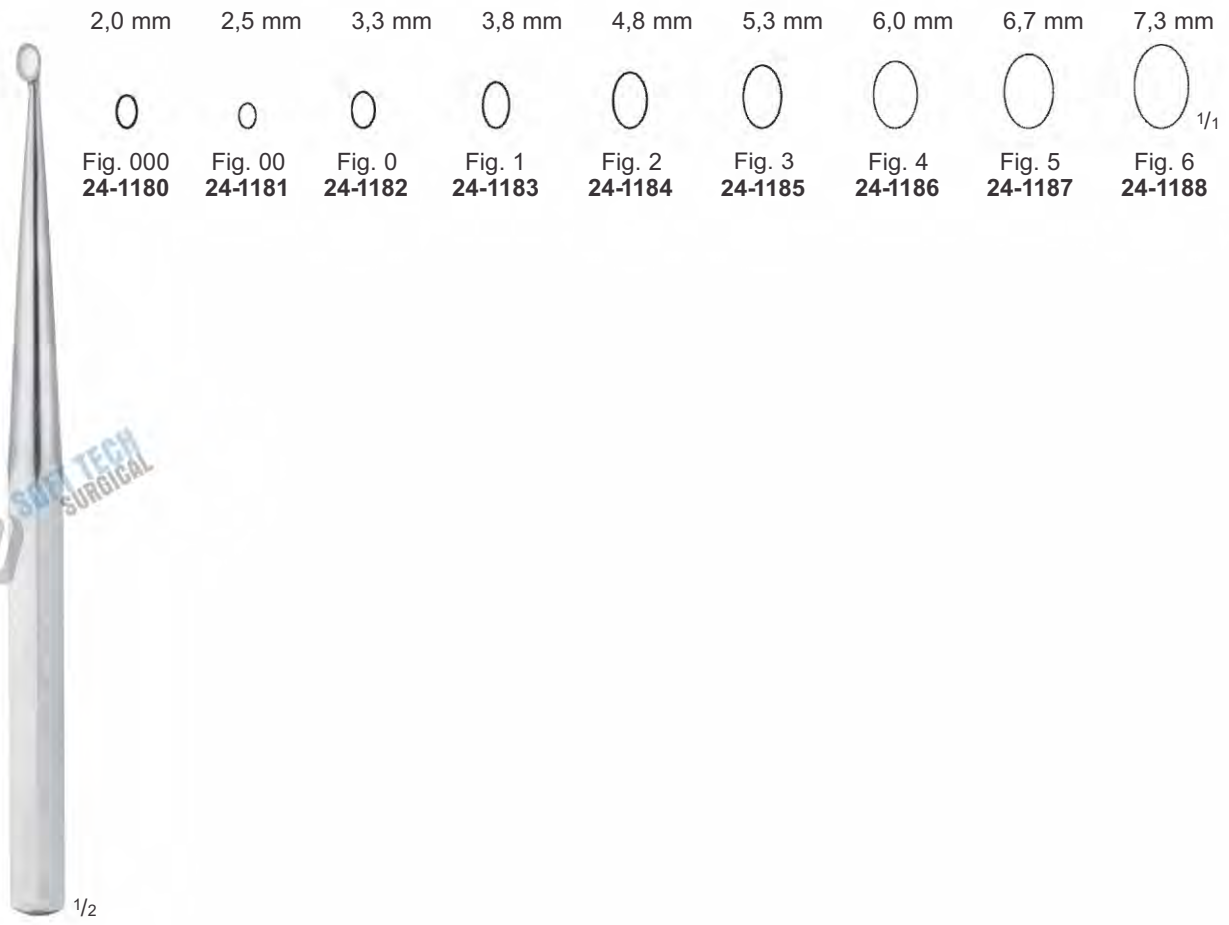

BRUNS CURETTE  
230 mm

SOFT TECH Surgical, Manufacturer & Exporter of Quality Instruments

3.6 mm



Fig. 000  
24-1190

4.4 mm



Fig. 00  
24-1191

5.2 mm



Fig. 0  
24-1192



SIMON, BONE CURETTES  
235 mm

6.8 mm



Fig. 1  
24-1200

8.5 mm



Fig. 2  
24-1201

10 mm



Fig. 3  
24-1202

11.5 mm



Fig. 4  
24-1203

13 mm



Fig. 5  
24-1204

14.5 mm

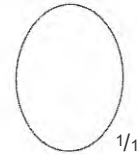

Fig. 6  
24-1205



SIMON UTERINE SCOOP  
240 mm

3.6 mm



Fig. 000  
24-1210

4.4 mm



Fig. 00  
24-1211

5.2 mm



Fig. 0  
24-1212



1/2

CASPAR BONE  
CURETTES  
220 mm

3.6 mm



Fig. 000  
24-1215

4.4 mm



Fig. 00  
24-1216

5.2 mm

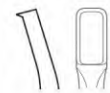

Fig. 0  
24-1217



1/2

CASPAR BONE  
CURETTES  
220 mm



4 mm  
24-1220



5 mm  
24-1221



6 mm  
24-1222



1/2

CASPAR CURETTES  
TOOTHED  
220 mm

SOFT TECH Surgical, Manufacturer & Exporter of Quality Instruments

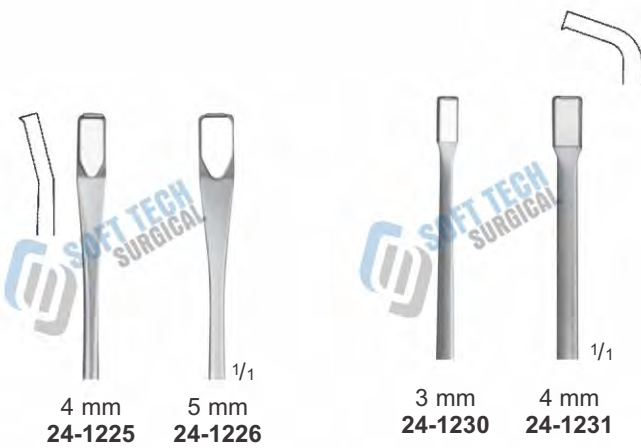

**CASPAR CURETTE  
TOOTHED  
250 mm**

**CASPAR CURETTE  
TOOTHED  
270 mm**



**BONE CURETTES  
270 mm**





**SOFT TECH  
SURGICAL**

## **General Surgery Instruments Catalogue**

### **SOFT TECH Surgical**

Muslim Town, Airport Road  
Kotli Behram, Sialkot 51310  
Pakistan.

Email : [info@softtechsurgical.com](mailto:info@softtechsurgical.com)  
Website : [www.softtechsurgical.com](http://www.softtechsurgical.com)

Phone : +92 52 3573488  
+92 52 3242929  
+92 52 4264934  
Fax : +92 52 3242929

 +92 336 4770459