



SOFT TECH  
SURGICAL

22

Spinal  
Instruments



SOFT TECH Surgical, Manufacturer & Exporter of Quality Instruments



Kerrison Laminectomy Punch  
90° jaw angle

90° UPWARD JAW  
180mm Shaft 200mm Shaft Bite Size

22-0100	22-0110	1mm
22-0101	22-0111	2mm
22-0102	22-0112	3mm
22-0103	22-0113	4mm
22-0104	22-0114	5mm
22-0105	22-0115	6mm

90° DOWNWARD JAW  
180mmShaft 200mm Shaft Bite Size

22-0120	22-0130	1mm
22-0121	22-0131	2mm
22-0122	22-0132	3mm
22-0123	22-0133	4mm
22-0124	22-0134	5mm
22-0125	22-0135	6mm

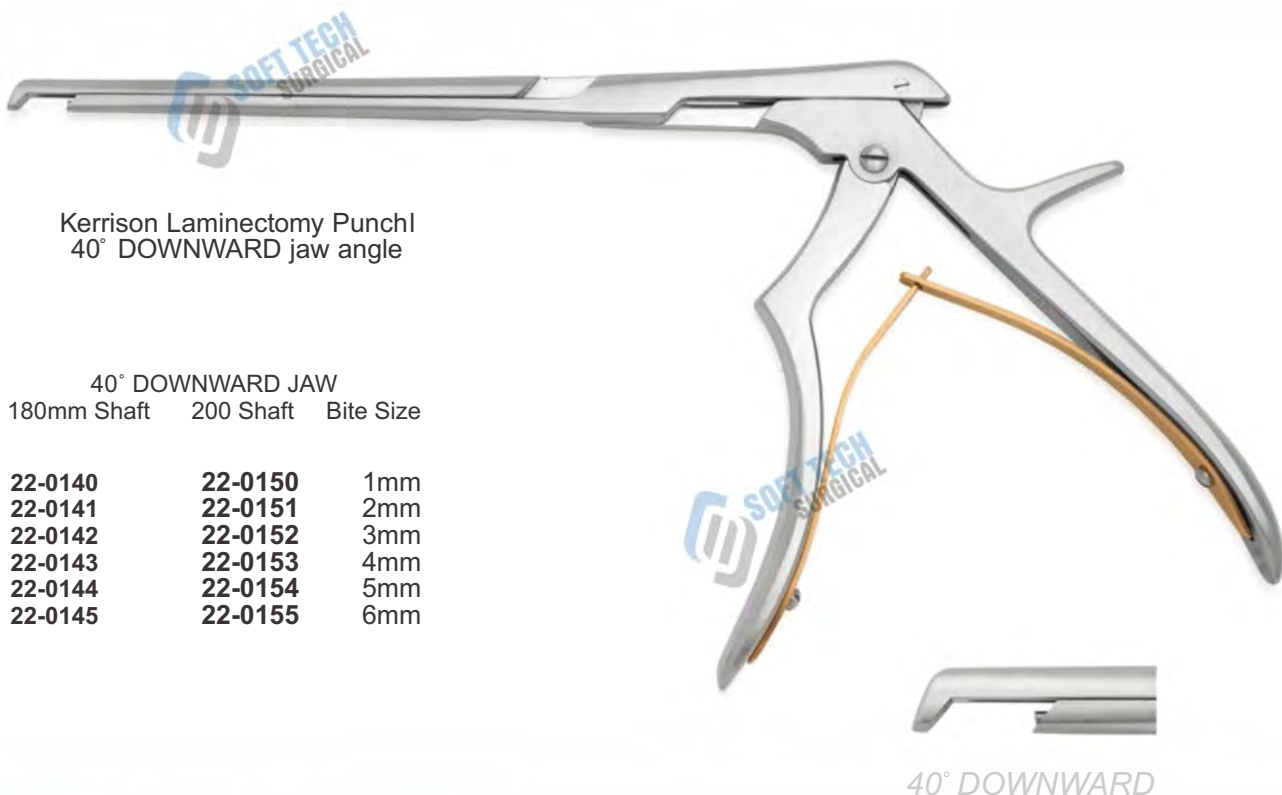

Kerrison Laminectomy Punch  
40° DOWNWARD jaw angle

40° DOWNWARD JAW  
180mm Shaft 200 Shaft Bite Size

22-0140	22-0150	1mm
22-0141	22-0151	2mm
22-0142	22-0152	3mm
22-0143	22-0153	4mm
22-0144	22-0154	5mm
22-0145	22-0155	6mm



'Black Line' Kerrison Laminectomy Punch  
40° UPWARD jaw angle  
Black titanium coating & Gold Spring

40° UPWARD JAW			Bite Size
180mm Shaft	200mm Shaft	230mm Shaft	
22-0160	22-0170	22-0180	1mm
22-0161	22-0171	22-0181	2mm
22-0162	22-0172	22-0182	3mm
22-0163	22-0173	22-0183	4mm
22-0164	22-0174	22-0184	5mm
22-0165	22-0175	22-0185	6mm

\*1mm size not available with Bone Ejector



40° UPWARD

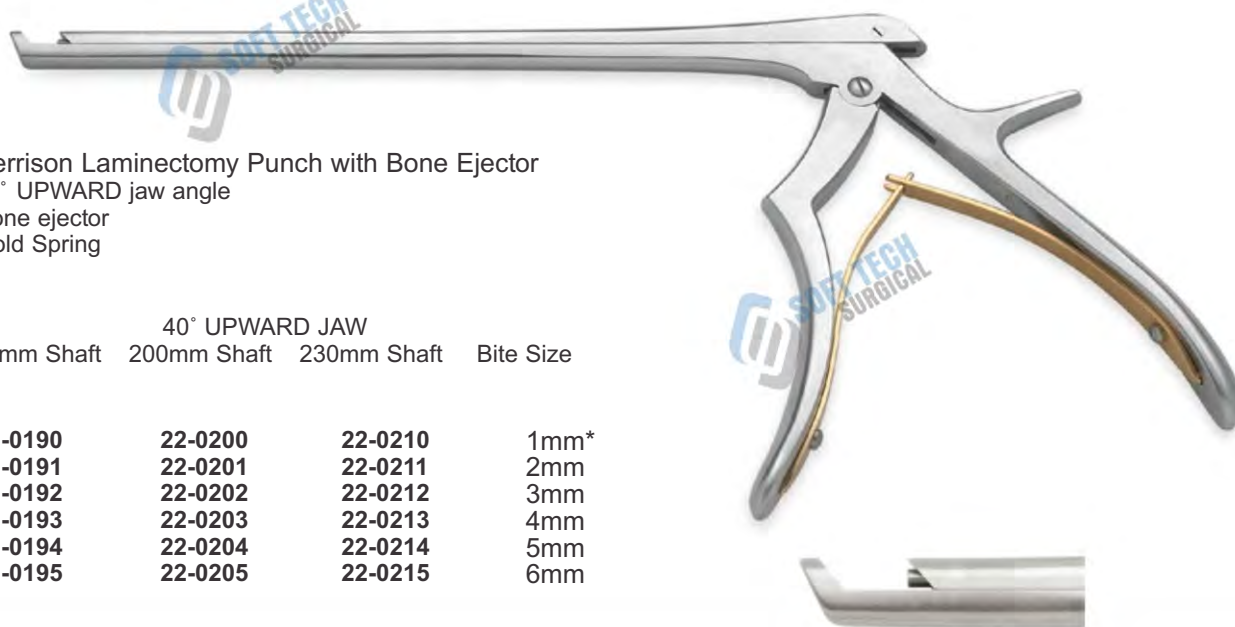

Kerrison Laminectomy Punch with Bone Ejector  
40° UPWARD jaw angle  
Bone ejector  
Gold Spring

40° UPWARD JAW			Bite Size
180mm Shaft	200mm Shaft	230mm Shaft	
22-0190	22-0200	22-0210	1mm*
22-0191	22-0201	22-0211	2mm
22-0192	22-0202	22-0212	3mm
22-0193	22-0203	22-0213	4mm
22-0194	22-0204	22-0214	5mm
22-0195	22-0205	22-0215	6mm

\*1mm size not available with Bone Ejector



40° UPWARD

SOFT TECH Surgical, Manufacturer & Exporter of Quality Instruments

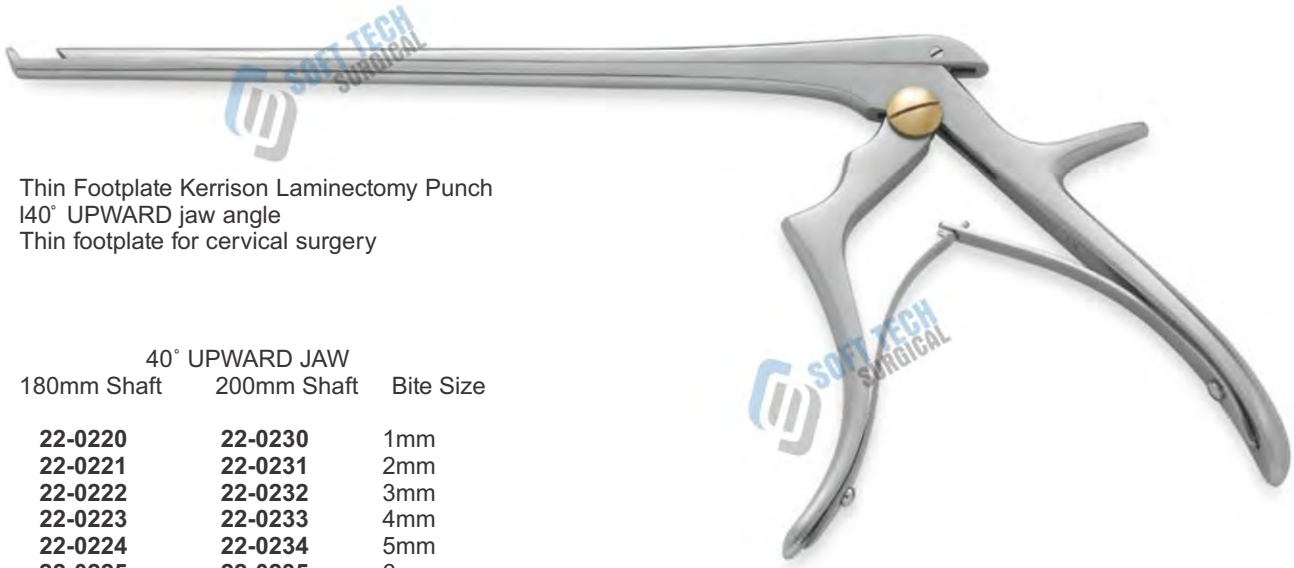

Thin Footplate Kerrison Laminectomy Punch  
140° UPWARD jaw angle  
Thin footplate for cervical surgery

40° UPWARD JAW		
180mm Shaft	200mm Shaft	Bite Size
<b>22-0220</b>	<b>22-0230</b>	1mm
<b>22-0221</b>	<b>22-0231</b>	2mm
<b>22-0222</b>	<b>22-0232</b>	3mm
<b>22-0223</b>	<b>22-0233</b>	4mm
<b>22-0224</b>	<b>22-0234</b>	5mm
<b>22-0225</b>	<b>22-0235</b>	6mm

Reduced footplate



40° UPWARD

A reduced footplate thickness useful for a restricted operating area



Wide Opening Kerrison Laminectomy Punch  
40° UPWARD jaw angle  
16mm wide opening jaw  
Bone ejector  
Black Titanium coating & Gold spring

40° UPWARD JAW	
200mm Shaft	Bite Size
<b>22-0240</b>	1mm*
<b>22-0241</b>	2mm
<b>22-0242</b>	3mm
<b>22-0243</b>	4mm
<b>22-0244</b>	5mm
<b>22-0245</b>	6mm

Wide opening jaws allowing the surgeon to envelope more bone

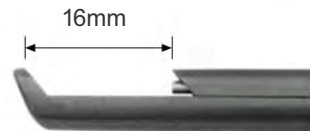

40° UPWARD

\*1mm not available with bone ejector



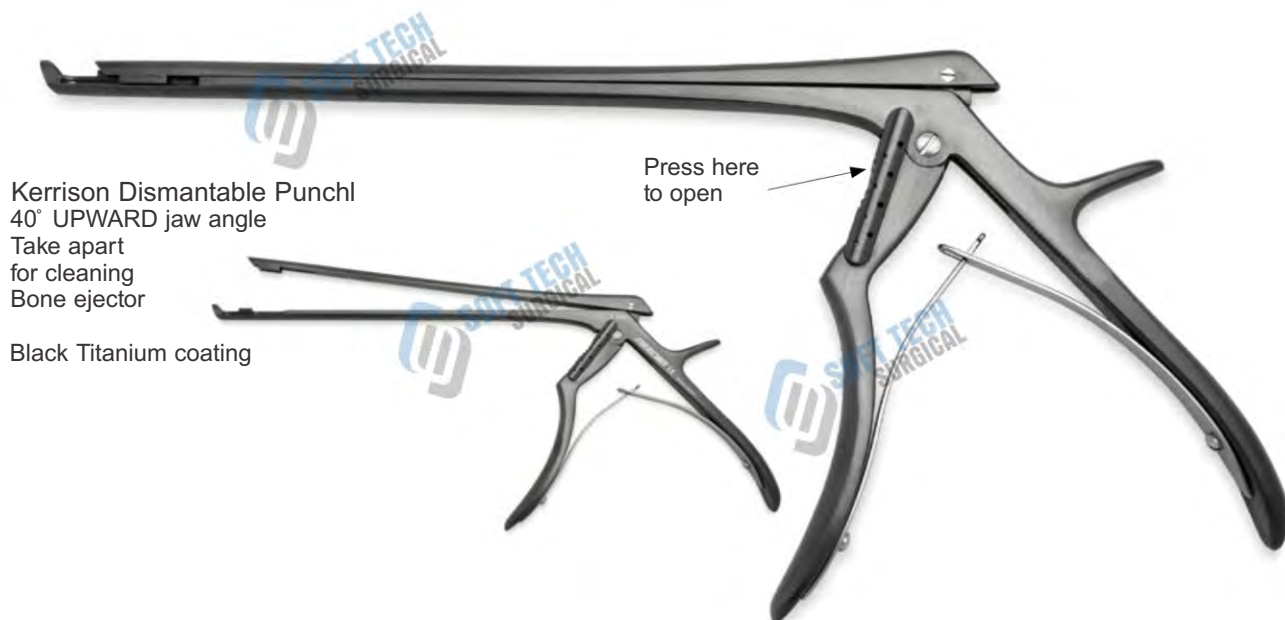

Kerrison Dismantable Punch  
40° UPWARD jaw angle  
Take apart  
for cleaning  
Bone ejector  
Black Titanium coating

		40° UPWARD JAW		
180mm Shaft	200mm Shaft	230mm Shaft		Bite Size
22-0250	22-0260	22-0270	1mm	
22-0251	22-0261	22-0271	2mm	
22-0252	22-0262	22-0272	3mm	
22-0253	22-0263	22-0273	4mm	
22-0254	22-0264	22-0274	5mm	
22-0255	22-0265	22-0275	6mm	



Curved Foramenotomy Punch  
40° UPWARD jaw angle  
Curved shaft designed to improve access to the foramen

200mm Shaft	Bite Size
22-0280	2mm
22-0281	3mm
22-0282	4mm

SOFT TECH Surgical, Manufacturer & Exporter of Quality Instruments



Long Anterior Kerrison Laminectomy Punch  
40° UPWARD jaw angle  
Extra-long shaft for thoracic approach  
Bone ejector

Black Titanium coating

40° UPWARD JAW	
280mm Shaft	Bite Size
<b>22-0290</b>	1mm*
<b>22-0291</b>	2mm
<b>22-0292</b>	3mm
<b>22-0293</b>	4mm
<b>22-0294</b>	5mm
<b>22-0295</b>	6mm



40° UPWARD

\*1mm not available with bone ejector

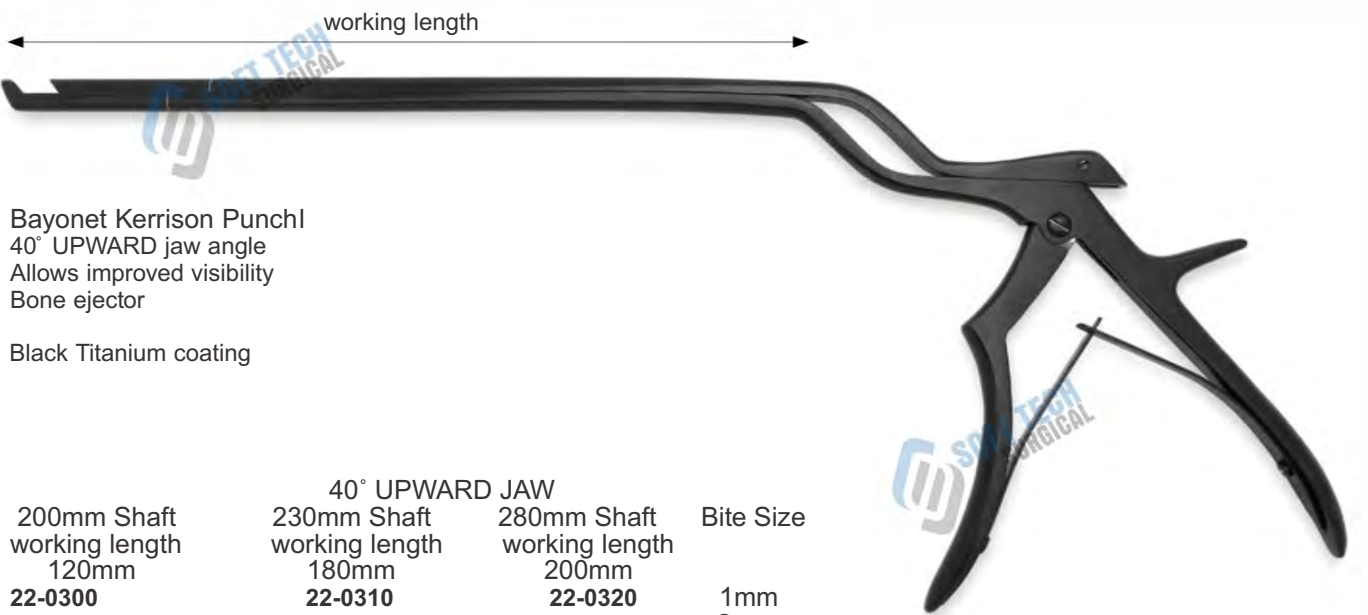

Bayonet Kerrison Punch  
40° UPWARD jaw angle  
Allows improved visibility  
Bone ejector

Black Titanium coating

40° UPWARD JAW			
200mm Shaft working length 120mm	230mm Shaft working length 180mm	280mm Shaft working length 200mm	Bite Size
<b>22-0300</b>	<b>22-0310</b>	<b>22-0320</b>	1mm
<b>22-0301</b>	<b>22-0311</b>	<b>22-0321</b>	2mm
<b>22-0302</b>	<b>22-0312</b>	<b>22-0322</b>	3mm
<b>22-0303</b>	<b>22-0313</b>	<b>22-0323</b>	4mm
<b>22-0304</b>	<b>22-0314</b>	<b>22-0324</b>	5mm

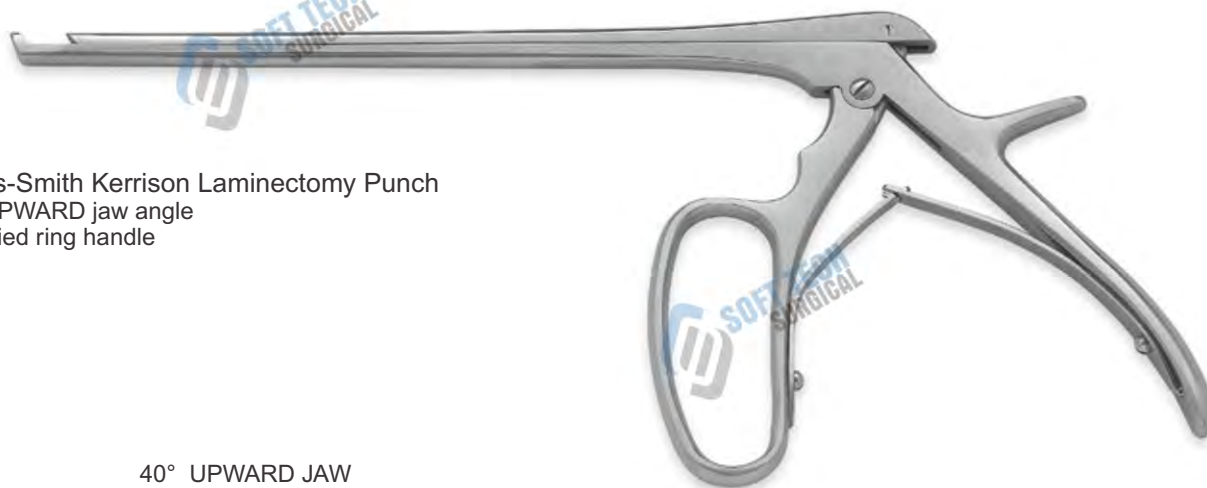

Ferris-Smith Kerrison Laminectomy Punch  
40° UPWARD jaw angle  
Modified ring handle

180mm Shaft	200mm Shaft	Bite Size
22-0330	22-0340	2mm
22-0331	22-0341	3mm
22-0332	22-0342	4mm
22-0333	22-0343	5mm
22-0334	22-0344	6mm



40° UPWARD

Intervertebral Disc Rongeur



STRAIGHT JAW

150mm Shaft	180mm Shaft	200mm Shaft	Bite Size
22-0350	22-0360	22-0370	1mm
22-0351	22-0361	22-0371	1.5mm
22-0352	22-0362	22-0372	2mm
22-0353	22-0363	22-0373	3mm
22-0354	22-0364	22-0374	4mm
22-0355	22-0365	22-0375	5mm
22-0356	22-0366	22-0376	6mm
22-0357	22-0367	22-0377	7mm

Intervertebral Disc Rongeur

150mm Shaft	40° ANGLED UPWARD JAW		Bite Size
	180mm Shaft	200mm Shaft	
22-0380	22-0390	22-0400	1mm
22-0381	22-0391	22-0401	1.5mm
22-0382	22-0392	22-0402	2mm
22-0383	22-0393	22-0403	3mm
22-0384	22-0394	22-0404	4mm
22-0385	22-0395	22-0405	5mm
22-0386	22-0396	22-0406	6mm
22-0387	22-0397	22-0407	7mm



Intervertebral Disc Rongeur

150mm Shaft	40° ANGLED DOWNWARD JAW		Bite Size
	180mm Shaft	200mm Shaft	
22-0410	22-0420	22-0430	1mm
22-0411	22-0421	22-0431	1.5mm
22-0412	22-0422	22-0432	2mm
22-0413	22-0423	22-0433	3mm
22-0414	22-0424	22-0434	4mm
22-0415	22-0425	22-0435	5mm
22-0416	22-0426	22-0436	6mm
22-0417	22-0427	22-0437	7mm





Caspar Toothed Disc Rongeur

Serrated and fenestrated jaws

STRAIGHT JAW		Bite Size
160mm Shaft	180mm Shaft	
<b>22-0440</b>	<b>22-0450</b>	2mm
<b>22-0441</b>	<b>22-0451</b>	3mm
<b>22-0442</b>	<b>22-0452</b>	4mm
<b>22-0443</b>	<b>22-0453</b>	5mm

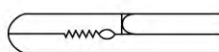

UPWARD JAW		Bite Size
160mm Shaft	180mm Shaft	
<b>22-0460</b>	<b>22-0470</b>	2mm
<b>22-0461</b>	<b>22-0471</b>	3mm
<b>22-0462</b>	<b>22-0472</b>	4mm
<b>22-0463</b>	<b>22-0473</b>	5mm

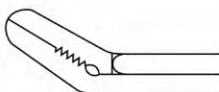

DOWNWARD JAW		Bite Size
160mm Shaft	180mm Shaft	
<b>22-0480</b>	<b>22-0490</b>	2mm
<b>22-0481</b>	<b>22-0491</b>	3mm
<b>22-0482</b>	<b>22-0492</b>	4mm
<b>22-0483</b>	<b>22-0493</b>	5mm

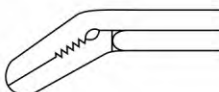

Schlesinger Toothed Rongeur  
Fine serration on the jaw edge

STRAIGHT JAW		Bite Size
150mm Shaft	180mm Shaft	
<b>22-0500</b>	<b>22-0510</b>	2mm
<b>22-0501</b>	<b>22-0511</b>	3mm
<b>22-0502</b>	<b>22-0512</b>	4mm

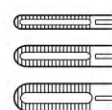

SOFT TECH Surgical, Manufacturer & Exporter of Quality Instruments

Williams Discectomy Rongeur  
140mm shaft length  
**22-0515**



Single toothed cup 1mm bite

Williams Discectomy Rongeur longer pattern  
230mm shaft length  
**22-0520**

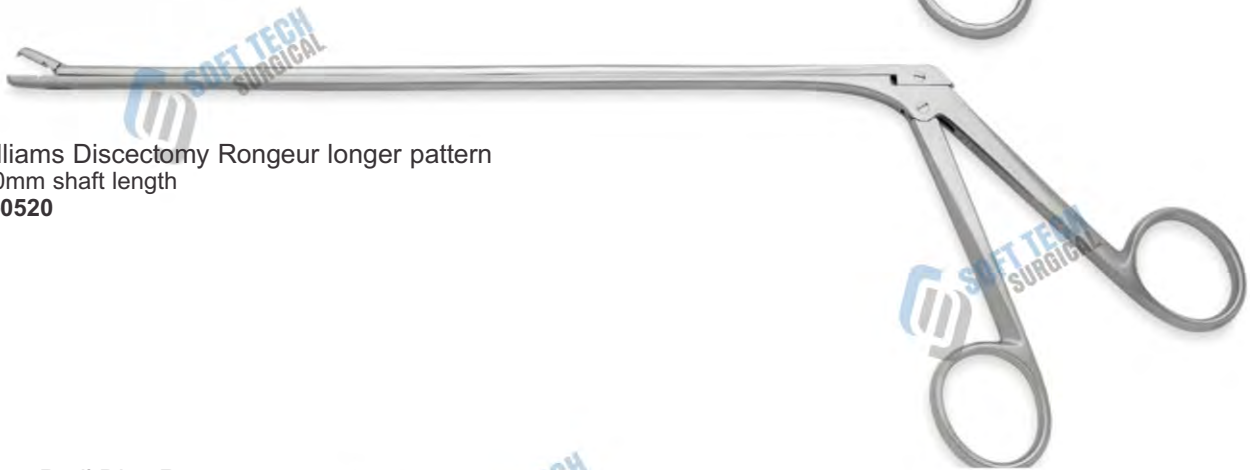

'Pea Pod' Disc Rongeur  
Short 10mm length jaw

150mm	Bite Size
<b>22-0525</b>	2mm
<b>22-0526</b>	3mm
<b>22-0527</b>	4mm



130mm      Bite Size  
**22-0530**      2mm  
Extra fine pattern 5mm length jaws

Beck Disc Rongeur  
130mm shaft length  
2mm bite size  
**22-0535**



**Munich Grasping Forceps**

180mm shaft length  
1x2 teeth  
Straight jaw

**22-0540**



Toothed serrated jaw

**Weil-Blakesley Forceps**

180mm shaft length  
Fenestrated jaw

Straight  
Jaw

**22-0545**  
**22-0546**  
**22-0547**

Bite Size  
2.5mm  
3.0mm  
3.5mm



Upward 30°  
Angled Jaw

**22-0550**  
**22-0551**  
**22-0552**

Bite Size  
2.5mm  
3.0mm  
3.5mm



**Decker Rongeur**

150mm shaft length  
Straight jaw

**22-0555**



2mm jaw

**Nicola Micro Cupped Biopsy Forceps**

165mm shaft length

**22-0560**

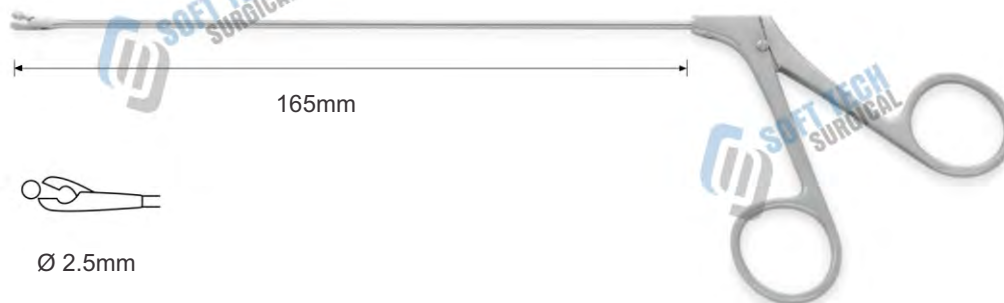

165mm

Ø 2.5mm

SOFT TECH Surgical, Manufacturer & Exporter of Quality Instruments

Micro Disc Rongeur  
170mm shaft length  
2mm bite size  
Black titanium coating

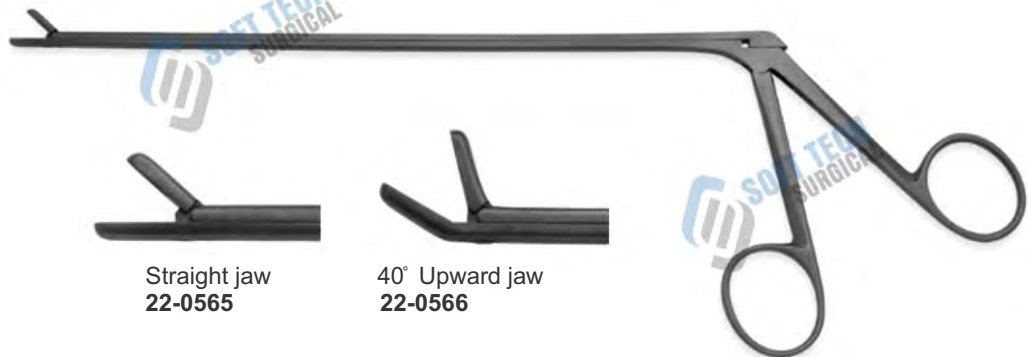

Straight jaw  
22-0565

40° Upward jaw  
22-0566

Micro Toothed Disc Rongeur

170mm shaft length  
2mm micro toothed jaw  
Black titanium coating



40° Upward jaw  
22-0570

Cushing Disc Rongeur

170mm shaft length  
2mm x 10mm jaw  
Black titanium coating



40° Upward jaw  
22-0575

Toothed Fine Disc Rongeur

170mm shaft length  
2mm fine toothed jaw  
Black titanium coating



Straight jaw  
22-0580



Ferris-Smith Disc Rongeur  
Ring handle

180mm Shaft	Straight Jaw 200mm Shaft	Bite Size
<b>22-0585</b>	<b>22-0590</b>	2mm
<b>22-0586</b>	<b>22-0591</b>	3mm
<b>22-0587</b>	<b>22-0592</b>	4mm
<b>22-0588</b>	<b>22-0593</b>	5mm

180mm Shaft	40° Upward Jaw 200mm Shaft	Bite Size
<b>22-0595</b>	<b>22-0600</b>	2mm
<b>22-0596</b>	<b>22-0601</b>	3mm
<b>22-0597</b>	<b>22-0602</b>	4mm
<b>22-0598</b>	<b>22-0603</b>	5mm



Anterior Disc Rongeur  
280mm shaft length  
Longer 28cm shaft for greater reach in the anterior approach

Straight	Upward	Bite Size
<b>22-0610</b>	<b>22-0615</b>	2mm
<b>22-0611</b>	<b>22-0616</b>	3mm
<b>22-0612</b>	<b>22-0617</b>	4mm
<b>22-0613</b>	<b>22-0618</b>	5mm



Anterior Disc Rongeur  
350mm shaft length  
Extra-long length shaft for deeper areas

Straight	Upward	Bite Size
<b>22-0620</b>	-	2.4mm
<b>22-0621</b>	<b>22-0625</b>	4mm
<b>22-0622</b>	-	6mm with teeth
<b>22-0623</b>	<b>22-0626</b>	8mm with teeth



SOFT TECH Surgical, Manufacturer & Exporter of Quality Instruments



Lempert Bone Nibbler  
190mm  
Single action



Luer Bone Nibbler  
180mm  
Single action

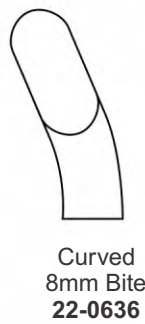

Adson Bone Nibbler  
200mm  
Single action

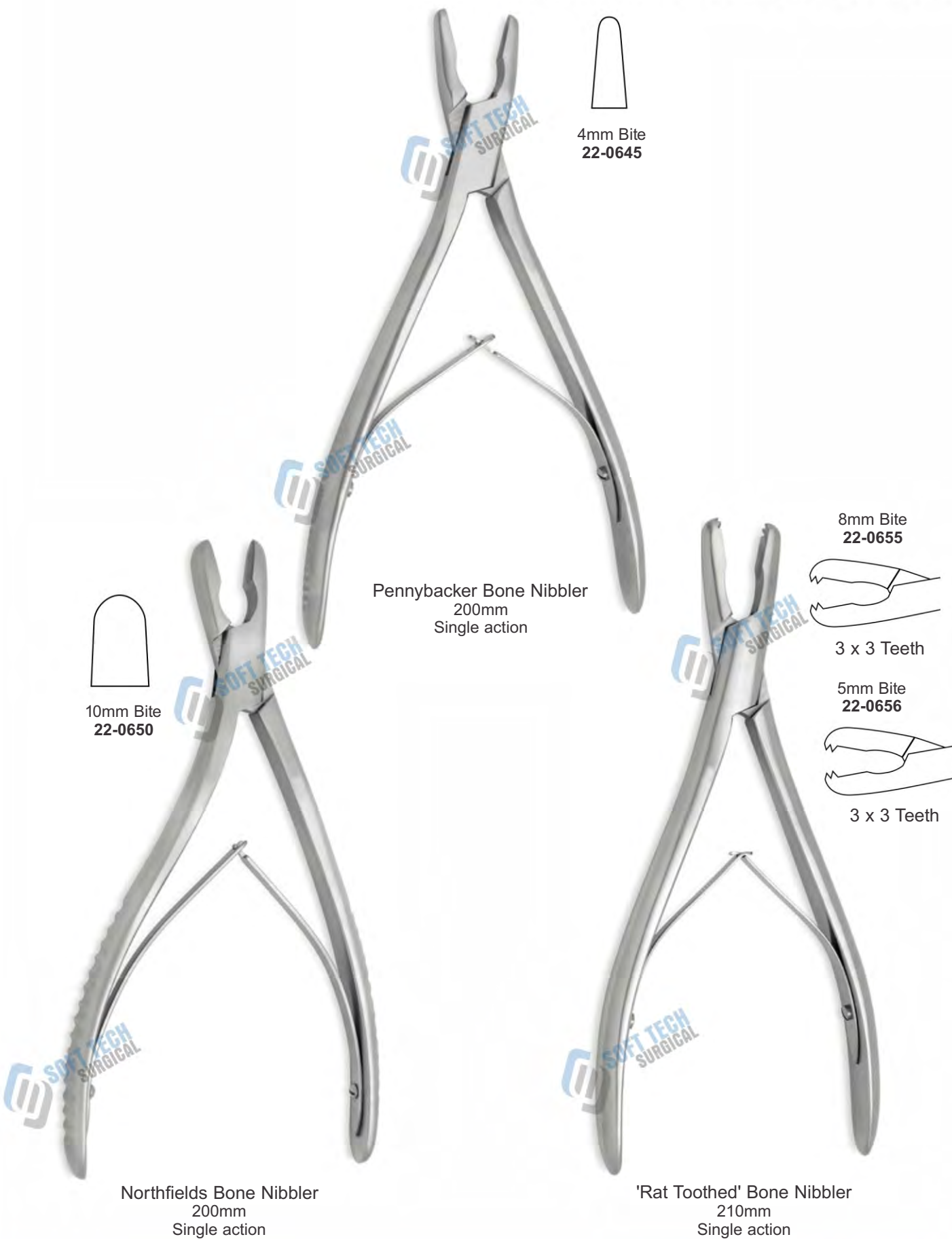

4mm Bite  
22-0645

Pennybacker Bone Nibbler  
200mm  
Single action

10mm Bite  
22-0650

Northfields Bone Nibbler  
200mm  
Single action

8mm Bite  
22-0655

3 x 3 Teeth

5mm Bite  
22-0656

3 x 3 Teeth

'Rat Toothed' Bone Nibbler  
210mm  
Single action

SOFT TECH Surgical, Manufacturer & Exporter of Quality Instruments

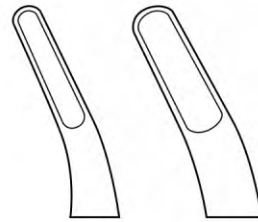

3mm Bite    5mm Bite

Zielke Intervertebral Rongeur  
Angled parallel jaws

	210mm	250mm	Bite Size
<b>22-0660</b>	<b>22-0665</b>		3mm
<b>22-0661</b>	<b>22-0666</b>		5mm



8mm Bite  
**22-0670**

Matzen Intervertebral Rongeur  
200mm  
Angled jaws



4mm Bite  
**22-0675**

Beyer Bone  
180mm  
Curved double action





5mm Bite  
22-0680

Jansen Bone Nibbler  
180mm  
Curved double action



3mm Bite  
22-0685

Marquardt Bone Nibbler  
200mm  
Curved double action



Straight  
3 mm bite

Light Curve  
3 mm bite

Smith-Peterson Bone Nibbler  
240mm  
Double action

Straight	Light Curve	Bite Size
22-0690	22-0695	3mm
22-0691	22-0696	4mm
22-0692	22-0697	5mm
22-0693	22-0698	6mm

SOFT TECH Surgical, Manufacturer & Exporter of Quality Instruments

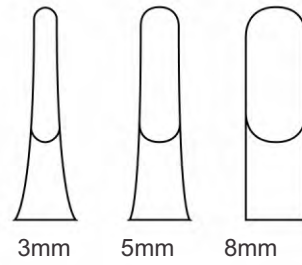

Angled Jaw	Bite Size
<b>22-0705</b>	3mm
<b>22-0706</b>	5mm
<b>22-0707</b>	8mm

Leksell Bone Nibbler  
240mm  
Double action angled

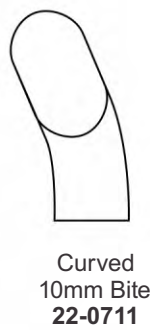
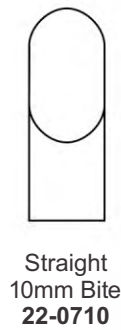

Stille-Luer Bone Nibbler  
220mm  
Double action

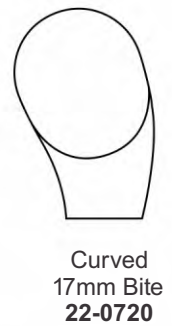

Stille-Luer Bone Nibbler  
260mm  
Double action



2mm Bite  
22-0720

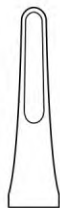

3mm Bite  
22-0721

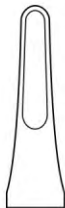

4mm Bite  
22-0722

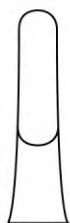

5mm Bite  
22-0725



8mm Bite  
22-0726



22-0730



8mm Bite  
22-0731



Long Anterior Leksell Bone Nibbler  
300mm  
Double action



Echlin Duckbill Nibbler  
230mm  
Double action

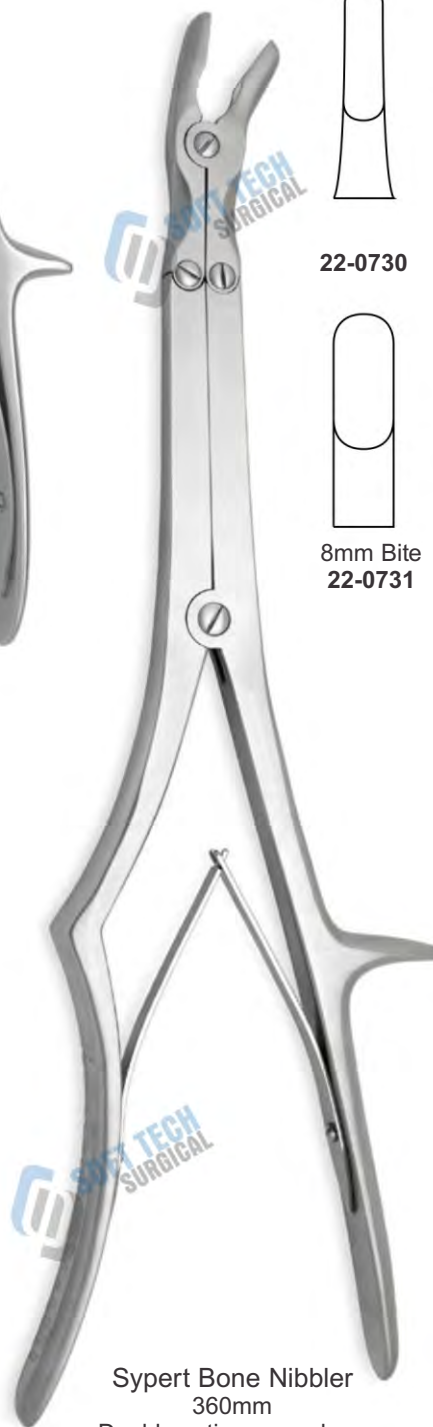

Sybert Bone Nibbler  
360mm  
Double action - very long

SOFT TECH Surgical, Manufacturer & Exporter of Quality Instruments



22-0735

McIndoe Bone Cutters  
180mm  
Double action  
Angled jaws



Straight  
22-0740



Angled  
22-0741

Stille-Liston Bone Cutters  
270mm



22-0745

Liston-Key-Horsley Bone Cutters  
270mm





	Width
22-0750	10mm
22-0751	12mm
22-0752	15mm
22-0753	20mm
22-0754	25mm
22-0755	30mm

Capener Osteotome  
250mm  
Tufnol handle



Straight	Width
22-0770	5mm
22-0771	10mm
22-0772	15mm
22-0773	20mm
22-0774	25mm
22-0775	30mm

Angled	Width
22-0780	5mm
22-0781	10mm
22-0782	15mm
22-0783	20mm
22-0784	25mm
22-0785	30mm

Dahmen Osteotome  
300mm  
Tufnol handle



22-0760
22-0761
22-0762
22-0763
22-0764

Lexer Osteotome  
220mm  
Tufnol handle

Width		
		5mm
		10mm
		15mm
		20mm
		25mm
		30mm

SOFT TECH Surgical, Manufacturer & Exporter of Quality Instruments



Width  
**22-0790** 5mm  
**22-0791** 7mm



Width  
**22-0795** 4mm  
**22-0796** 6mm  
**22-0797** 8mm

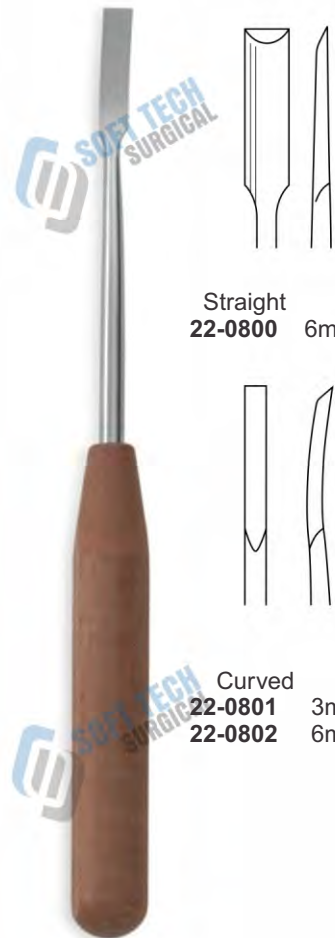

Straight  
**22-0800** 6mm

Curved  
**22-0801** 3mm  
**22-0802** 6mm

Adson Periosteal Elevator  
160mm  
Curved blunt

Pennybacker Periosteal Elevator  
160mm  
Curved sharp

Bone Raspatory with Tufnol Handle  
190mm



Straight  
**22-0805** 12mm  
 Curved\*  
**22-0806** 12mm



Straight  
**22-0810** 12mm  
 Curved\*  
**22-0811** 12mm

Farabeuf Rugine Elevator  
150mm

Farabeuf Rugine Elevator  
With Hollow Handle  
160mm



Trethowan Bone Elevator  
225mm  
22-0815



Bristow Periosteal Elevator  
230mm  
Curved sharp  
10mm width  
22-0830



Zielke S-Shaped Gouge  
230mm

Curved\*  
22-0820 6mm  
22-0801 9mm



S-Shaped Width  
22-0825 6mm  
22-0826 9mm



Capener Lamina Gouge  
230mm  
Cranked shaft

22-0835 6mm  
22-0836 8mm  
22-0837 11mm  
22-0838 16mm

SOFT TECH Surgical, Manufacturer & Exporter of Quality Instruments



Swedish Dissector  
**22-0840**  
180mm



Size  
**22-0845** 180mm  
**22-0846** 230mm  
**22-0847** 255mm

Watson Cheyne Dissector



Howarth Elevator  
**22-0850**  
215mm

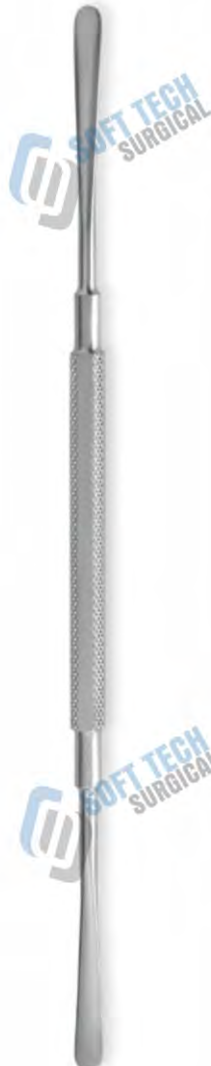

Freers Elevator/Dissector  
**22-0855**  
185mm



MacDonald  
Elevator/Dissector  
Size  
**22-0860** 180mm  
**22-0861** 230mm



**Bruns Curette 230mm**

Cup Size	Model Number
0000	22-0870
000	22-0871
00	22-0872
0	22-0873
1	22-0874
2	22-0875
3	22-0875

**Lempert Curette 210mm**

Cup Size	Model Number
00000	22-0890
0000	22-0891
000	22-0892
00	22-0893
0	22-0894
1	22-0895

**Tufnol Handle Micro Curette 260mm**

Configuration	Cup Size	Model Number
Straight	00000	22-0900
	00000	22-0901
	000	22-0902
	00	22-0903
	0	22-0904
Angled	00000	22-0905
	00000	22-0910
	000	22-0911
	00	22-0912
	0	22-0913
Angled	0000	22-0920
	000	22-0921
	00	22-0922
	0	22-0923
Angled	1	22-0924

SOFT TECH Surgical, Manufacturer & Exporter of Quality Instruments



Cobb Bone Curette  
280mm

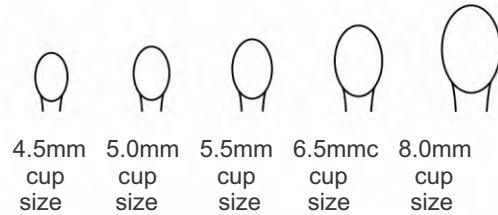

Straight	Cup Size	Angled	Cup Size
<b>22-0930</b>	2.0mm	<b>22-0940</b>	2.0mm
<b>22-0931</b>	2.5mm	<b>22-0941</b>	2.5mm
<b>22-0932</b>	3.0mm	<b>22-0942</b>	3.0mm
<b>22-0933</b>	3.5mm	<b>22-0943</b>	3.5mm
<b>22-0934</b>	4.0mm	<b>22-0944</b>	4.0mm
<b>22-0935</b>	4.5mm	<b>22-0945</b>	4.5mm
<b>22-0936</b>	5.0mm	<b>22-0946</b>	5.0mm
<b>22-0937</b>	5.5mm	<b>22-0947</b>	5.5mm
<b>22-0938</b>	6.5mm	<b>22-0948</b>	6.5mm
<b>22-0939</b>	8.0mm	<b>22-0949</b>	8.0mm

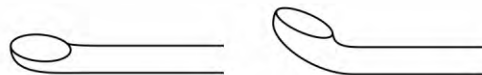
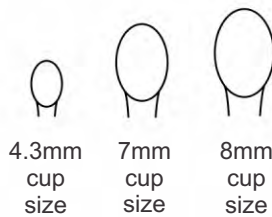

Straight	Cup Size	Angled	Cup Size
<b>22-0950</b>	4.3mm	<b>22-0955</b>	4.3mm
<b>22-0951</b>	7mm	<b>22-0956</b>	7mm
<b>22-0952</b>	8mm	<b>22-0957</b>	8mm



Long Anterior Curette  
380mm

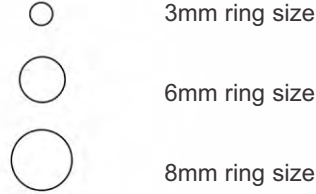

Straight	Ring Size	Angled	Ring Size
<b>22-0960</b>	3mm	<b>22-0965</b>	3mm
<b>22-0961</b>	6mm	<b>22-0966</b>	6mm
<b>22-0962</b>	8mm	<b>22-0967</b>	8mm



Cones Ring Curette  
230mm

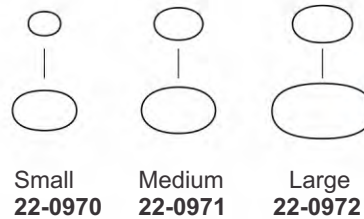

Volkman  
Double Ended Curette  
220mm

SOFT TECH Surgical, Manufacturer & Exporter of Quality Instruments

Drill Guide



**22-0975**  
Right



**22-0980**  
Left



Screw Driver  
**22-0985**



Distraction Drill  
For pre-drilling pilot holes for distraction  
screws in combination with the drill guide  
Drill 2mm Ø  
**22-0990**



Caspar Distraction Screws  
70mm post length  
Sterile packed



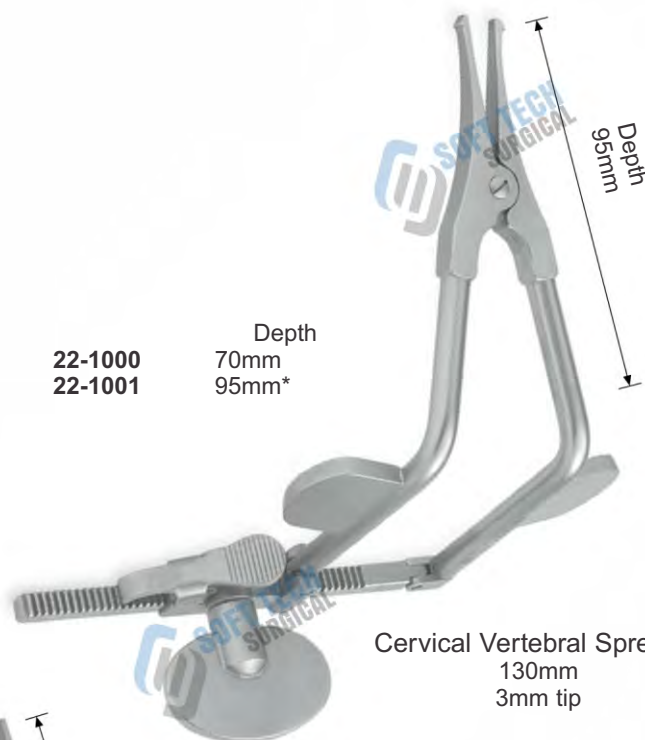

SOFT TECH Surgical, Manufacturer & Exporter of Quality Instruments

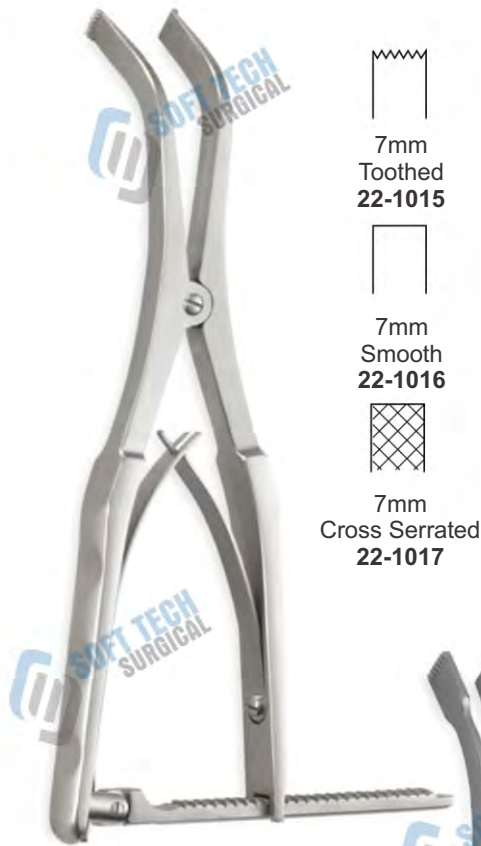

Baby Inge Lamina Spreader  
180mm







SOFT TECH Surgical, Manufacturer & Exporter of Quality Instruments

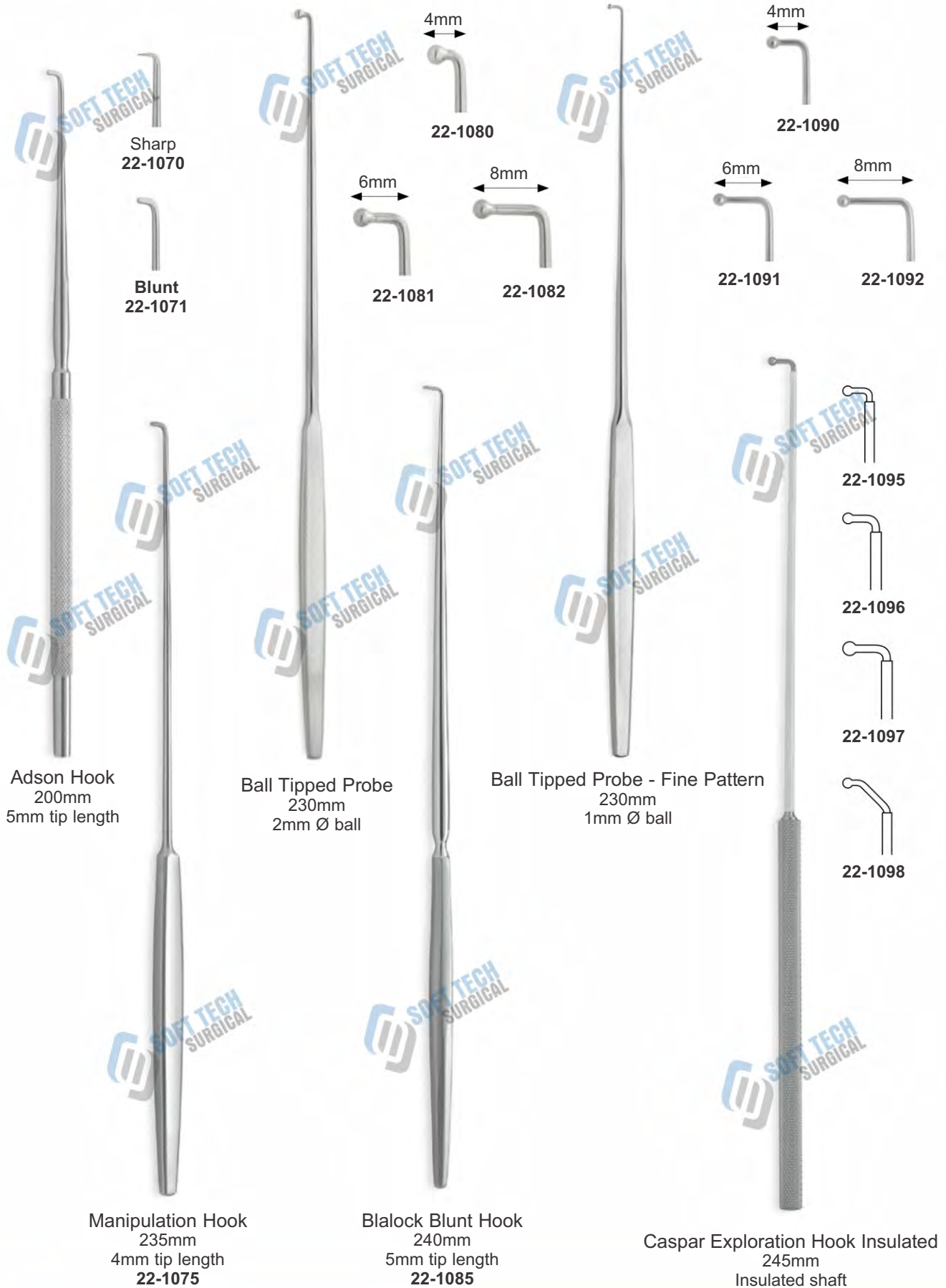



General Surgery  
Instruments  
Rhoton Micro Dissectors  
Titanium Blue Coating



SOFT TECH Surgical, Manufacturer & Exporter of Quality Instruments

No.1  
1mm Small  
22-1100

No.2  
2mm Medium  
22-1101

No.3  
3mm Large  
22-1102

No.4  
Curved  
22-1105

No.5  
Angled  
22-1106

Titanium Micro Round Dissectors  
190mm

No.6  
1mm Small  
22-1110

No.7  
1.7mm Medium  
22-1111

No.8  
2mm Large  
22-1112

Titanium Micro Elevators  
190mm

No.9  
90° Semi-sharp  
22-1115

No.10  
90° Blunt  
22-1116

No.11  
45° Semi-sharp  
22-1117

No.12  
Straight point Needle  
22-1118

Titanium Micro Spatula Dissectors  
190mm

Titanium Micro Hooks  
190mm

SOFT TECH Surgical, Manufacturer & Exporter of Quality Instruments

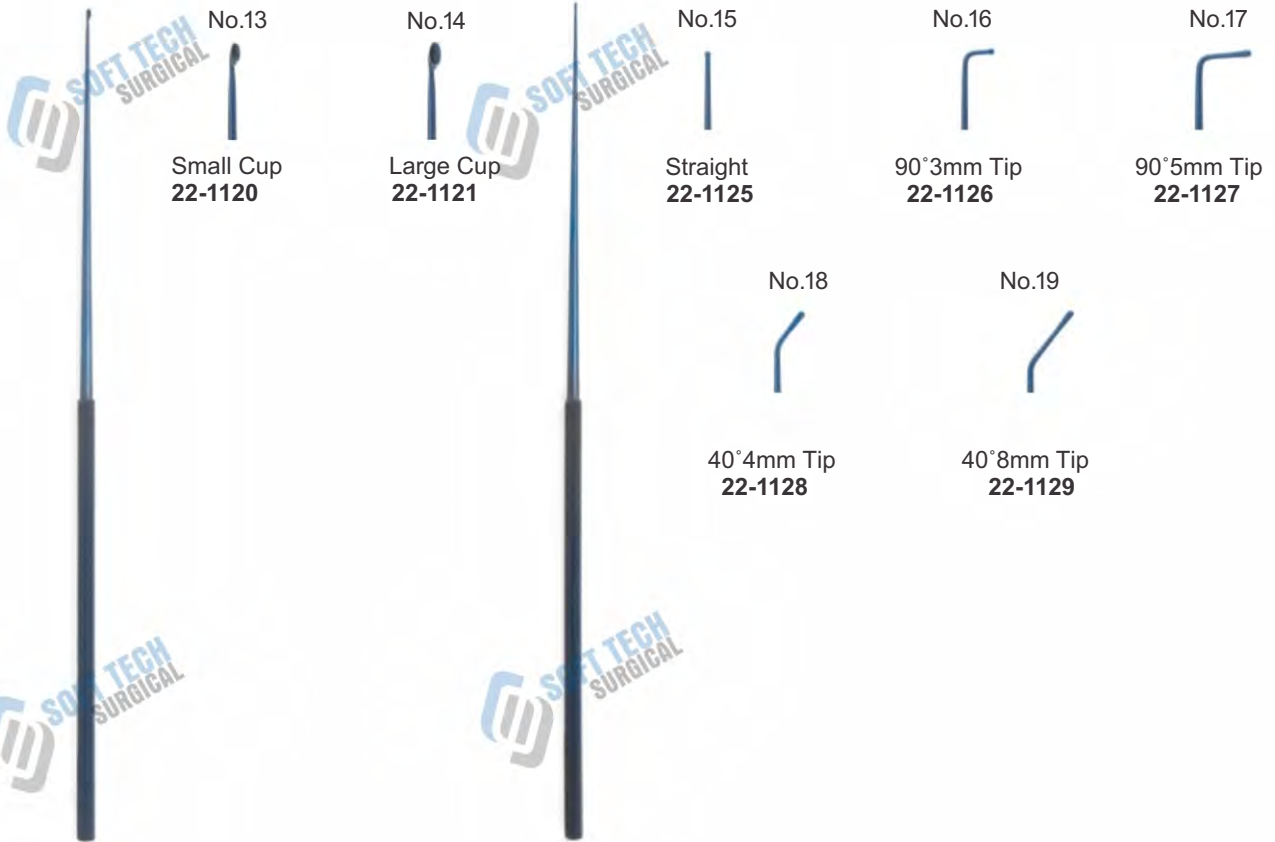

Titanium Micro Curettes  
190mm

Titanium Micro Ball Dissectors  
190mm

Complete Set  
Including Rack and 19 Micro Dissectors  
22-1130





**22-1135**  
Width 4mm

Krayenbuhl Nerve  
Root Retractor  
Double bayonet

	Width
210mm <b>22-1140</b>	3mm
240mm <b>22-1141</b>	4mm



Caspar Bayonet Nerve  
Root Retractor  
240mm

	Width
<b>22-1145</b>	4mm
<b>22-1146</b>	6mm

100mm length



Love Bayonet Nerve  
Root Retractor  
210mm



Love Nerve Root Retractor  
220mm  
5mm tip width  
**22-1155** Straight  
**22-1156** 25° Angled  
**22-1157** 90° Angled

O'Connell Nerve Root Retractor  
215mm  
**22-1155**



McCulloch Nerve Root Retractor  
125mm working length  
90° angled  
6mm tip  
**22-1160**

SOFT TECH Surgical, Manufacturer & Exporter of Quality Instruments

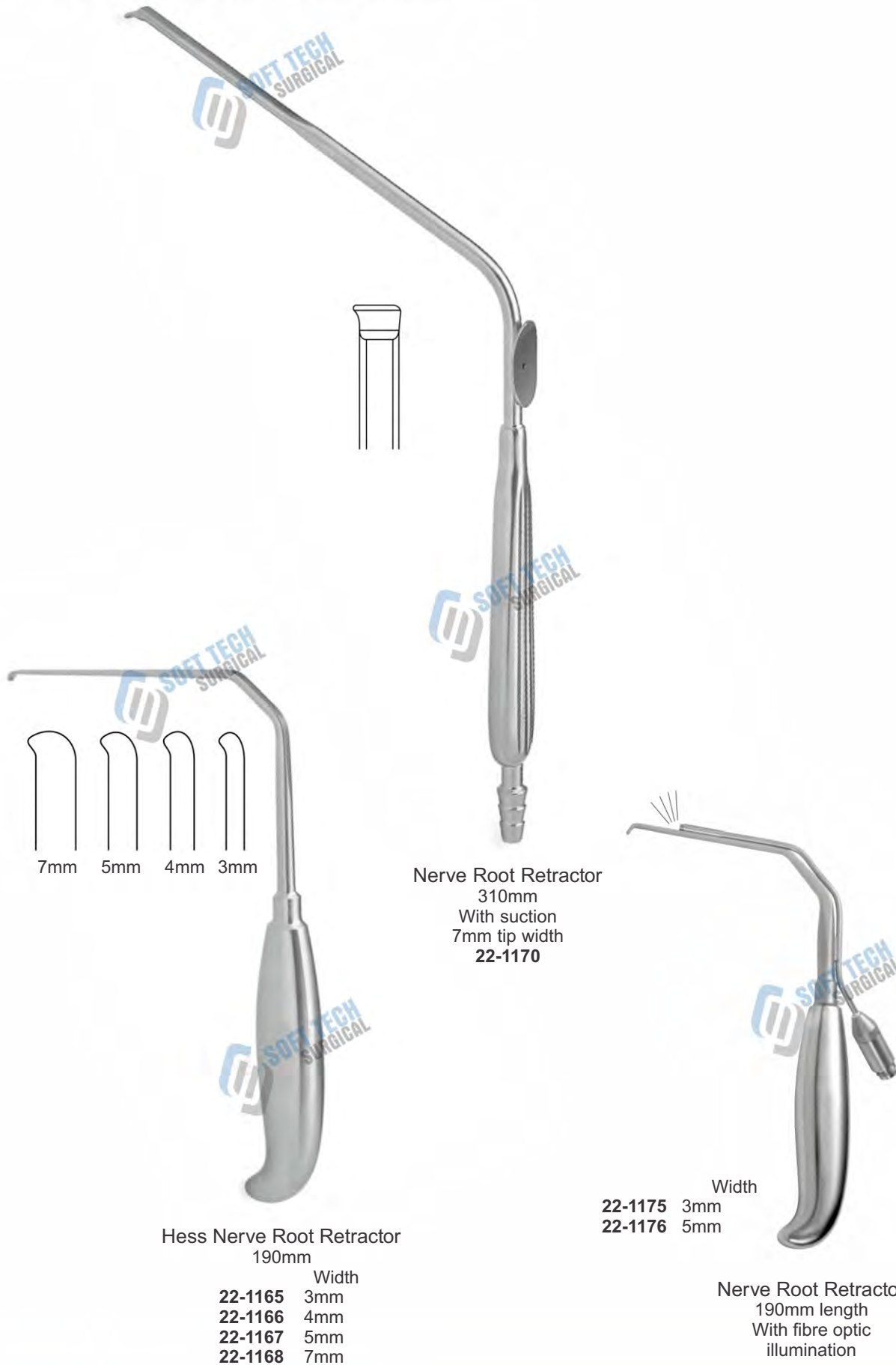

Hess Nerve Root Retractor  
190mm

	Width
22-1165	3mm
22-1166	4mm
22-1167	5mm
22-1168	7mm

Nerve Root Retractor  
310mm  
With suction  
7mm tip width  
22-1170

	Width
22-1175	3mm
22-1176	5mm

Nerve Root Retractor  
190mm length  
With fibre optic  
illumination



Meyerding Retractor  
225mm



	Blade size
<b>22-1180</b>	50mm x 16mm
<b>22-1181</b>	75mm x 25mm
<b>22-1182</b>	90mm x 50mm

Langenbeck Retractor  
215mm



	Blade size	
<b>22-1185</b>	22mm x 6mm	Small
<b>22-1186</b>	45mm x 13mm	Medium
<b>22-1187</b>	65mm x 25mm	Large
<b>22-1188</b>	90mm x 20mm	X-Large

Taylor Hip Retractor  
190mm

	Depth
<b>22-1190</b>	70mm
<b>22-1191</b>	85mm
<b>22-1192</b>	100mm



Volkman Catspaw  
Retractor  
215mm  
Semi sharp teeth



15 x 15mm  
3 Prong  
**22-1200**



15 x 20mm  
4 Prong  
**22-1201**

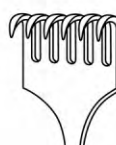

15 x 30mm  
6 Prong  
**22-1202**

Cloward Style Blade Retractor  
110mm

	Width
<b>22-1195</b>	13mm
<b>22-1196</b>	18mm
<b>22-1197</b>	20mm



SOFT TECH Surgical, Manufacturer & Exporter of Quality Instruments



West's S/R Retractor  
140mm  
3 x 4 Sharp prongs  
Prong depth 18mm  
**22-1205**



Mollison S/R Retractor - Child  
130mm  
2 x 2 Sharp prongs 12mm depth  
**22-1210**

Weitlaner S/R Retractor  
140mm  
3 x 4 Blunt prongs  
Prong depth 18mm  
**22-1206**



Mollison S/R Retractor - Adult  
170mm  
4 x 4 Sharp prongs 15mm depth  
**22-1215**

Jefferson S/R Retractor  
130mm  
3 x 4 Blunt prongs 16mm depth  
**22-1220**





Irwin S/R Retractor  
175mm  
4 x 4 Sharp prongs  
Prong depth 20mm  
**22-1225**



Travers S/R Retractor  
200mm  
4 x 5 Blunt prongs  
Prong depth 26mm  
**22-1230**



Norfolk and Norwich S/R Retractor  
200mm  
4 x 5 Blunt prongs  
Prong depth 50mm x  
23mm width  
**22-1235**



Norfolk and Norwich Deeper  
Prongs S/R Retractor  
200mm  
4 x 5 Blunt prongs  
Prong depth 70mm x  
23mm width  
**22-1240**

SOFT TECH Surgical, Manufacturer & Exporter of Quality Instruments

**Cones Self Retaining Retractor**

3 x 4 Prongs

Jointed arms

Blunt Prongs	Length	Depth	Sharp Prongs	Length	Depth
<b>22-1250</b>	130mm	15mm	<b>22-1260</b>	130mm	15mm
<b>22-1251</b>	160mm	15mm	<b>22-1261</b>	160mm	15mm
<b>22-1252</b>	200mm	20mm	<b>22-1262</b>	200mm	20mm
<b>22-1253</b>	240mm	25mm	<b>22-1263</b>	240mm	25mm



**Harvey Jackson Self Retaining  
Retractor**  
280mm  
Prong depth 45mm  
3x3 Sharp prongs  
**12-0395**



**Beckman - Adson Retractor**  
330mm  
4 x 5 Blunt prongs  
Prong depth 32mm  
Jointed arms  
**22-1275**



Gelpi Laminectomy Retractor

	Sharp Prongs	Prong depth
185mm	<b>22-1280</b>	30mm
195mm	<b>22-1281</b>	50mm
200mm	<b>22-1282</b>	70mm
200mm	<b>22-1283</b>	90mm

	Blunt Prongs	Prong depth
185mm	<b>22-1290</b>	30mm
195mm	<b>22-1291</b>	50mm
200mm	<b>22-1292</b>	70mm
200mm	<b>22-1293</b>	90mm

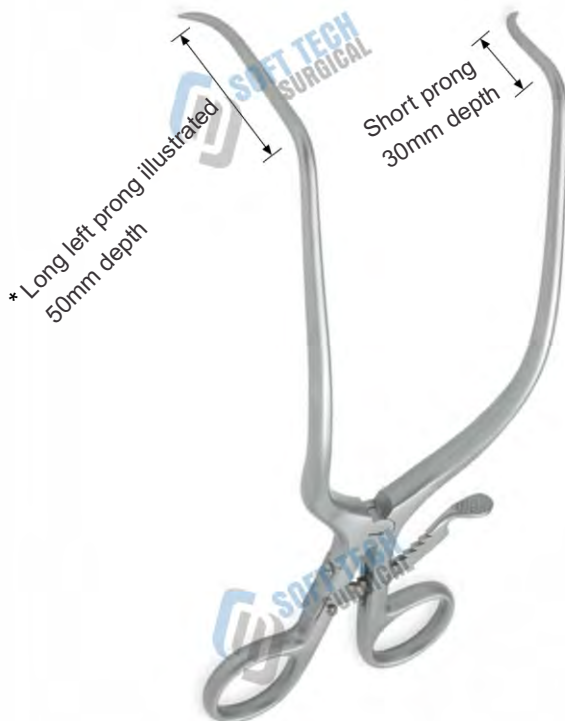

Hardman Retractor  
200 mm

	Prong depth
<b>22-1300</b>	50mm equal prongs
<b>22-1301</b>	long prong - Left*
<b>22-1302</b>	long prong - Right

Meyerding Hemi  
Laminectomy Retractor  
180mm



Solid Blade Left	Blade Size	Solid Blade Right	
<b>22-1310</b>	50 x 10mm	<b>22-1320</b>	Narrow Blade
<b>22-1311</b>	60 x 10mm	<b>22-1321</b>	
<b>22-1312</b>	70 x 10mm	<b>22-1322</b>	
<b>22-1315</b>	50 x 20mm	<b>22-1325</b>	Wide Blade
<b>22-1316</b>	60 x 20mm	<b>22-1326</b>	
<b>22-1317</b>	70 x 20mm	<b>22-1327</b>	

SOFT TECH Surgical, Manufacturer & Exporter of Quality Instruments

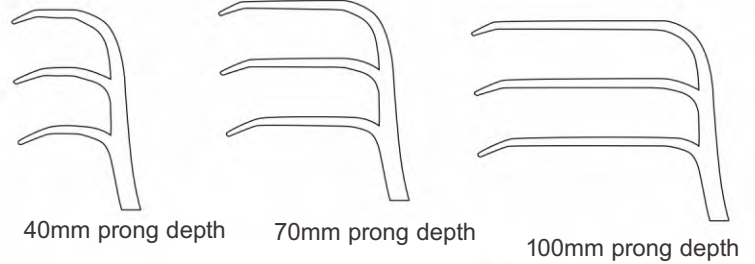

Depth Prongs  
22-7248-38H 40mm  
22-7248-40H 70mm  
22-7248-50H 100mm

Viper Hinged Scoliosis Retractor  
300mm  
Sharp



Depth Prongs  
22-7248-38 40mm  
22-7248-40 70mm  
22-7248-50 100mm

Viper Scoliosis Retractor  
300mm  
Sharp prongs

Jointed Arms



Jointed arms  
Maximum spread 70mm  
**22-1340**  
Retractor Frame  
Rigid arms  
**22-1341**

Retractor Frame  
Extra long rack 140mm spread **22-1342**



Wide Muscle  
Blades - 6 Teeth

27mm width  
**22-1370** 3cm depth  
**22-1371** 4cm depth  
**22-1372** 5cm depth  
**22-1373** 6cm depth  
**22-1374** 7cm depth  
**22-1375** 8cm depth  
**22-1376** 9cm depth  
**22-1377** 10cm depth  
**22-1378** 12cm depth

Extra deep {



Hook Blades

**22-1390** 2cm depth  
**22-1391** 3cm depth  
**22-1392** 4cm depth  
**22-1393** 5cm depth  
**22-1394** 6cm depth  
**22-1395** 7cm depth  
**22-1396** 8cm depth  
**22-1397** 9cm depth  
**22-1398** 10cm depth

Extra deep {



Narrow Muscle  
Blades - 4 Teeth

20mm width  
**22-1360** 3cm depth  
**22-1361** 4cm depth  
**22-1362** 5cm depth  
**22-1363** 6cm depth  
**22-1364** 7cm depth  
**22-1365** 8cm depth  
**22-1366** 9cm depth  
**22-1367** 10cm depth  
**22-1368** 12cm depth

Extra deep {



Toothed Blades

**22-1380** 2cm depth  
**22-1381** 3cm depth  
**22-1382** 4cm depth  
**22-1383** 5cm depth  
**22-1384** 6cm depth  
**22-1385** 7cm depth  
**22-1386** 8cm depth  
**22-1387** 9cm depth  
**22-1388** 10cm depth

Extra deep {



Thin Muscle  
Blades - 2 Teeth

17mm width  
**22-1350** 3cm depth  
**22-1351** 4cm depth  
**22-1352** 5cm depth  
**22-1353** 6cm depth  
**22-1354** 7cm depth  
**22-1355** 8cm depth



SOFT TECH Surgical, Manufacturer & Exporter of Quality Instruments

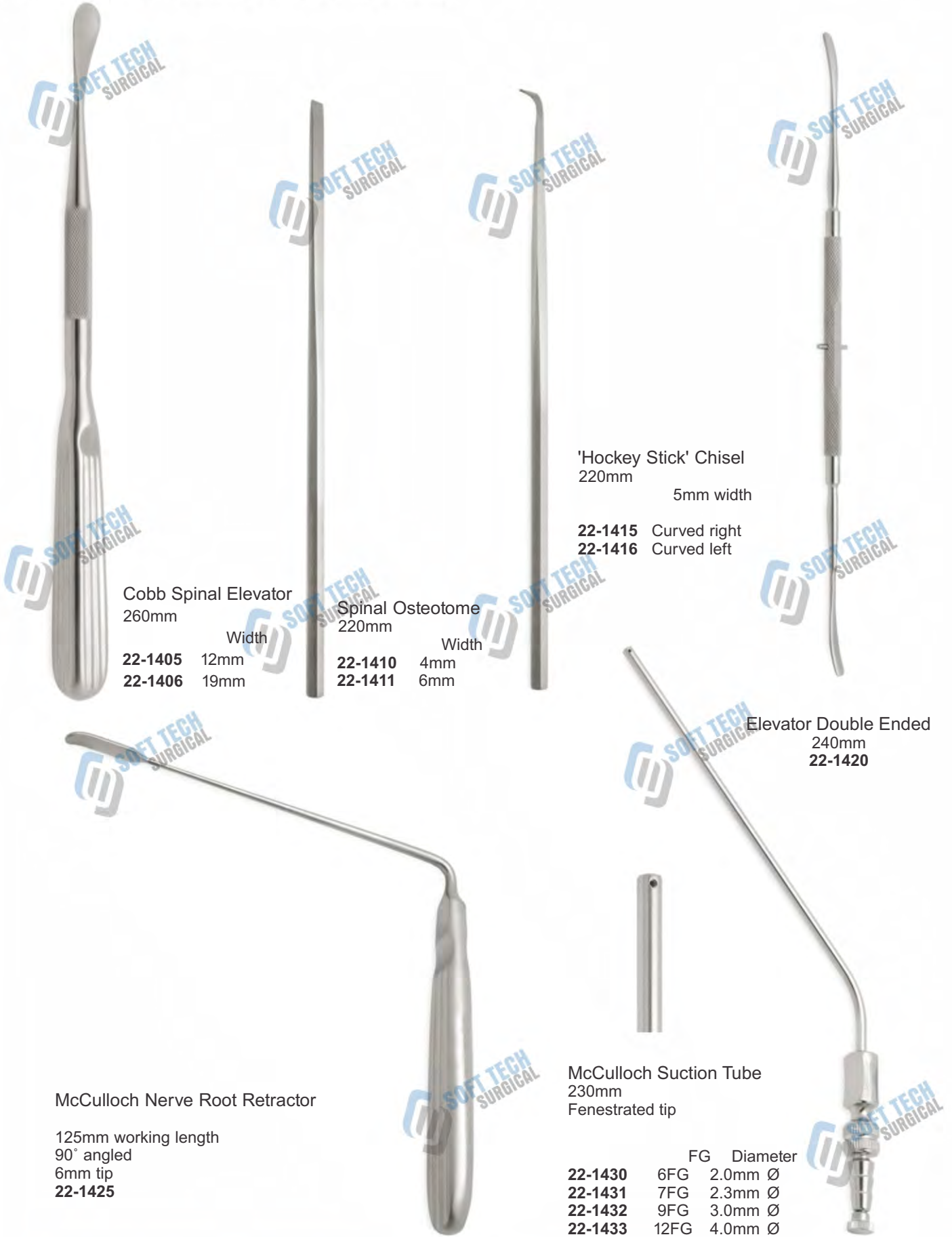

**Cobb Spinal Elevator**  
260mm

	Width
<b>22-1405</b>	12mm
<b>22-1406</b>	19mm

**Spinal Osteotome**  
220mm

	Width
<b>22-1410</b>	4mm
<b>22-1411</b>	6mm

**'Hockey Stick' Chisel**  
220mm

5mm width

- 22-1415** Curved right
- 22-1416** Curved left

**Elevator Double Ended**  
240mm  
**22-1420**

**McCulloch Nerve Root Retractor**

125mm working length  
90° angled  
6mm tip  
**22-1425**

**McCulloch Suction Tube**  
230mm  
Fenestrated tip

	FG	Diameter
<b>22-1430</b>	6FG	2.0mm Ø
<b>22-1431</b>	7FG	2.3mm Ø
<b>22-1432</b>	9FG	3.0mm Ø
<b>22-1433</b>	12FG	4.0mm Ø



General Surgery  
Instruments  
Caspar Micro Lumbar &  
Discectomy Retractor Set



SOFT TECH Surgical, Manufacturer & Exporter of Quality Instruments



**Caspar Micro Discectomy Retractor**

This Retractor Set allows a micro surgery approach to Lumbar Disc  
Specula have a black surface finish to prevent glare  
Fenestrated blades on the specula reduce the risk of movement  
during surgery  
Black Titanium Coated Frame & Blades  
Matt Finish

**Complete Set**

**22-1440**

Consisting of:

Lateral Blades	Depth	Specula	Depth
22-1450	40mm	22-1460	40mm
22-1451	45mm	22-1461	45mm
22-1452	50mm	22-1462	50mm
22-1453	55mm	22-1463	55mm
22-1454	60mm	22-1464	60mm
22-1455	65mm	22-1465	65mm
22-1456	75mm	22-1466	75mm
22-1457	80mm	22-1467	80mm
22-1458	85mm	22-1468	85mm
22-1459	100mm	22-1469	100mm

Optional extra depth

- 22-1475 Counter Retractor Frame
- 22-1476 Blade Ejector Forceps
- 22-1477 Sterilising Container
- 22-1478 Tray Insert for Specula
- 22-1479 Tray Insert for Lateral Blades
- Black Titanium Coated Frame & Blades  
Matt Finish

SOFT TECH Surgical, Manufacturer & Exporter of Quality Instruments

Lateral Blades  
Black Titanium Coated



Blade Ejector Forceps  
22-1490  
Black Titanium Coated



Specula Range  
Black Titanium Coated



Casper Micro Discectomy  
Retractor Frame  
22-1500

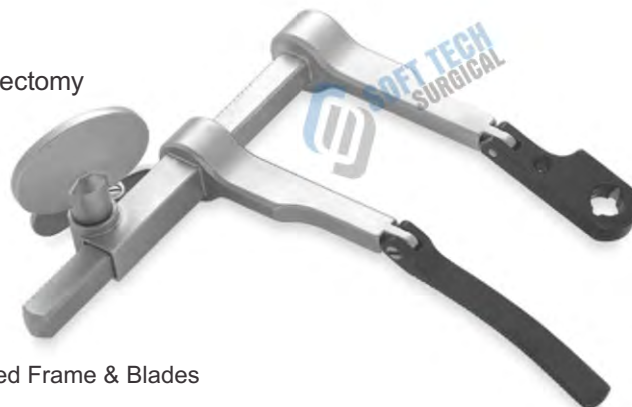

Black Titanium Coated Frame & Blades  
Matt Finish

# General Surgery

## Instruments

### Piccolino Mini Lumbar & Retractor Set



SOFT TECH Surgical, Manufacturer & Exporter of Quality Instruments

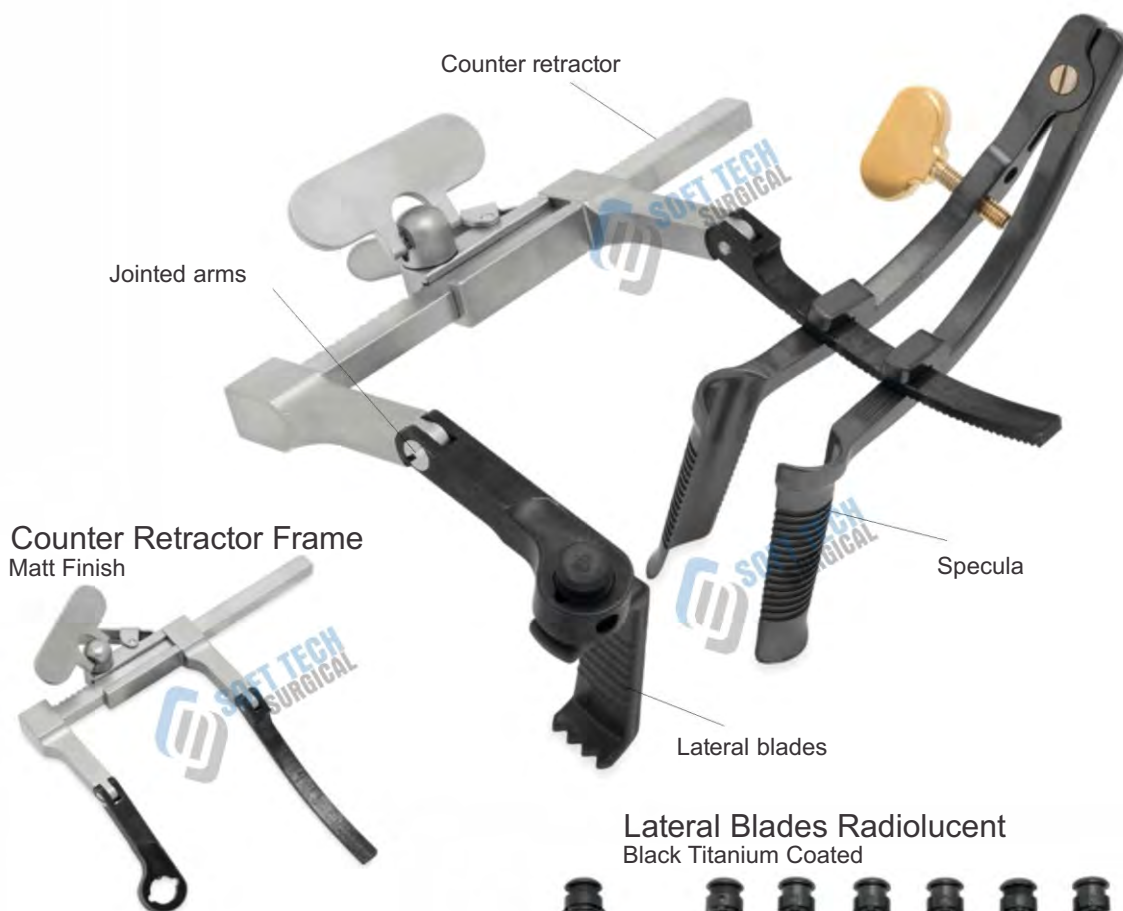

Counter Retractor Frame  
Matt Finish

Lateral Blades Radiolucent  
Black Titanium Coated



Piccolino Mini Lumbar Retractor Set

Micro Lumbar Surgery  
Lateral blades are radiolucent  
Reduced 20mm incision

Complete Set  
22-1510

Consisting of:

Lateral Blades	Depth	Specula	Depth
22-1520	40mm	22-1530	40mm
22-1521	45mm	22-1531	45mm
22-1522	50mm	22-1532	50mm
22-1523	55mm	22-1533	55mm
22-1524	60mm	22-1534	60mm
22-1525	65mm	22-1535	65mm
22-1526	75mm	22-1536	75mm
		22-1537	85mm
22-1540	Counter Retractor Frame		

Specula  
Black Titanium Coated





SOFT TECH Surgical, Manufacturer & Exporter of Quality Instruments



Spoon shaped jaws  
225mm **22-1560** Tip size 3mm  
225mm **22-1561** Tip size 5mm



Flat serrated jaws  
225mm **22-1565** Tip size 3mm  
225mm **22-1566** Tip size 5mm



Curette toothed jaws  
225mm **22-1570** Tip size 3mm  
225mm **22-1571** Tip size 5mm



Yasargil Bayonet Tumour Grasping Forceps  
Flat handled

Yasargil Bayonet Micro Forceps  
Flat handled  
Blunt tips

Tip size  
225mm **22-1550** 1mm  
240mm **22-1551** 1mm



Tip size



Bayonet Tumour Grasping Forceps  
Round bodied  
Flat serrated jaws  
230mm **22-1575** 5mm



Tip size

Bayonet Micro Forceps  
Round bodied  
210mm **22-1555** 1mm  
230mm **22-1556** 1mm



SOFT TECH Surgical, Manufacturer & Exporter of Quality Instruments



With Lock 230mm	Straight <b>22-1580</b>	Curved <b>22-1585</b>
Without Lock 230mm	Straight <b>22-1581</b>	Curved <b>22-1586</b>

Yasargil Bayonet Micro  
Needle Holder  
Flat handled  
Delicate 1mm jaws



With Lock 210mm 230mm	Straight <b>22-1590</b> <b>22-1591</b>	Curved <b>22-1600</b> <b>22-1601</b>
Without Lock 210mm 23mm	Straight <b>22-1595</b> <b>22-1596</b>	Curved <b>22-1605</b> <b>22-1606</b>

Bayonet Micro Needle Holder  
Round bodied  
Delicate 1mm jaws



Yasargil Bayonet Micro Scissors  
Flat handled  
225mm



Curved  
**22-1610**



Straight  
**22-1615**

Regular  
Blades



Curved  
**22-1611**



Straight  
**22-1616**

Yannas  
Fine  
Blades

SOFT TECH Surgical, Manufacturer & Exporter of Quality Instruments



Regular Blades  
Curved  
**22-1620**

Regular Blades  
Straight  
**22-1621**



Vannas  
Fine Blades  
Curved  
**22-1625**

Vannas  
Fine Blades  
Straight  
**22-1626**



Yasargil Bayonet Micro Scissors  
Flat handled  
225mm



Yasargil Bayonet Micro Scissors  
Flat handled  
225mm

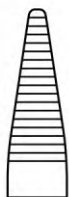

Slim Nose  
**22-1630**  
Serrated jaw



Square Ended\*  
**22-1631**



Slim & Square Ended Wire Pliers  
190mm



Muller Claus Wire Cutters  
Tungsten carbide edges  
**22-1635**  
180mm  
Cuts wire up to 2mm Ø  
**22-1636**  
220mm  
Cuts wire up to 3mm Ø



Combined Wire Cutters & Pliers  
180mm  
Suitable for wires up to 1.6mm Ø  
Parallel closing jaws  
**22-1640**

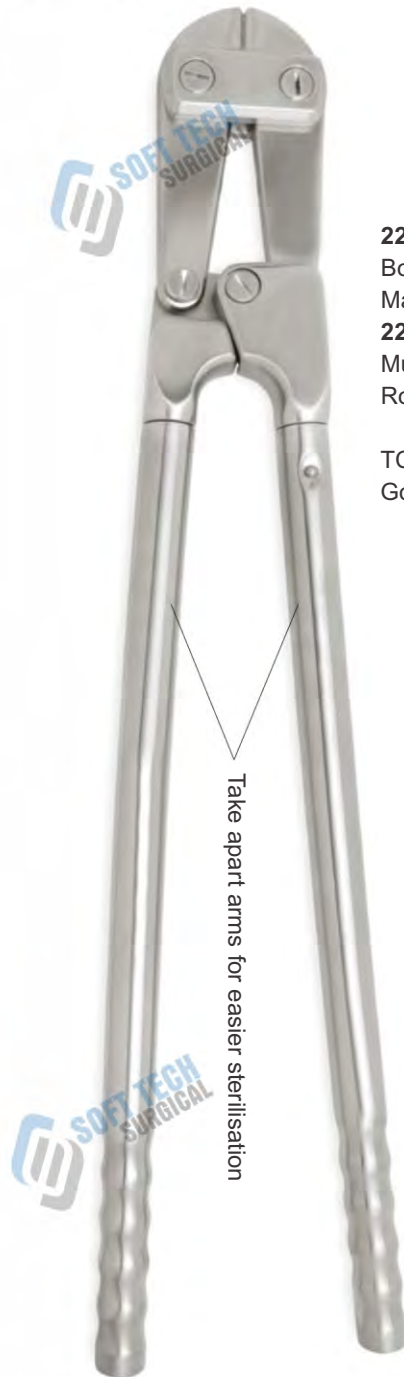

**22-1650**

Bolt Cutters with detachable arms  
Max. cap 6.3mm pins

**22-1655**

Must be used in conjunction with a  
Rod Holder.

TC Carbide Jaws  
Golden Handle



Orthopaedic Locking Pliers  
Hardened jaws

	Length	
<b>22-1645</b>	180mm	Small
<b>22-1646</b>	200mm	Medium
<b>22-1667</b>	240mm	Larg



Needle Nosed Locking Pliers

Code	Length	
<b>22-1660</b>	220mm	Small
<b>22-1661</b>	250mm	Medium
<b>22-1662</b>	300mm	Large

A very useful instrument for  
orthopaedic surgery allowing the  
surgeon to securely clamp on  
to wires and implants.





Measuring Caliper  
250mm  
Measuring range 0 to 50mm  
**22-1665**



Castroviejo Caliper  
70mm  
Measuring range 3mm to 25mm  
**22-1670**



Depth Gauge  
Measuring depth up to 50mm  
**22-1675**



Depth Gauge  
Measuring depth up to 70mm  
**22-1680**

SOFT TECH Surgical, Manufacturer & Exporter of Quality Instruments

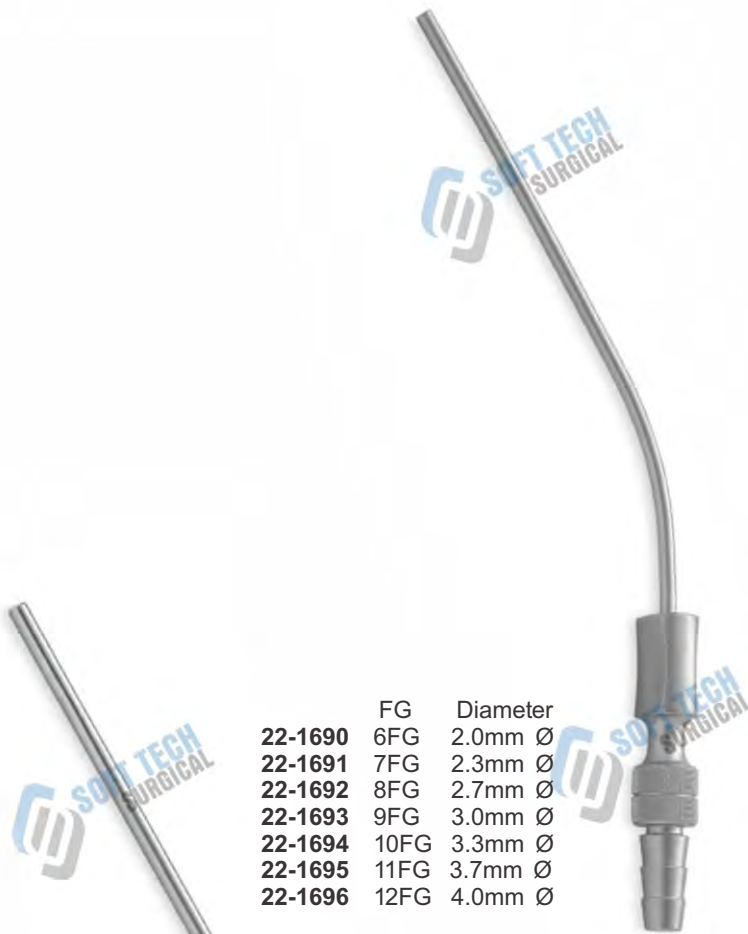

	FG	Diameter
<b>22-1690</b>	6FG	2.0mm Ø
<b>22-1691</b>	7FG	2.3mm Ø
<b>22-1692</b>	8FG	2.7mm Ø
<b>22-1693</b>	9FG	3.0mm Ø
<b>22-1694</b>	10FG	3.3mm Ø
<b>22-1695</b>	11FG	3.7mm Ø
<b>22-1696</b>	12FG	4.0mm Ø

Frazier Suction Tube  
170mm

	FG	Diameter
<b>22-1700</b>	6FG	2.0mm Ø
<b>22-1701</b>	7FG	2.3mm Ø
<b>22-1702</b>	8FG	2.7mm Ø
<b>22-1703</b>	9FG	3.0mm Ø
<b>22-1704</b>	10FG	3.3mm Ø
<b>22-1705</b>	11FG	3.7mm Ø
<b>22-1706</b>	12FG	4.0mm Ø

Frazier Suction Tube  
230mm



	Tip Size
<b>22-1710</b>	190mm
<b>22-1711</b>	1mm
<b>22-1711</b>	2mm

	Tip Size
<b>22-1715</b>	210mm
<b>22-1715</b>	1mm
<b>22-1716</b>	2mm

Bayonet Dissecting Forceps



**SOFT TECH  
SURGICAL**

## **General Surgery Instruments Catalogue**

### **SOFT TECH Surgical**

Muslim Town, Airport Road  
Kotli Behram, Sialkot 51310  
Pakistan.

Email : [info@softtechsurgical.com](mailto:info@softtechsurgical.com)  
Website : [www.softtechsurgical.com](http://www.softtechsurgical.com)

Phone : +92 52 3573488  
+92 52 3242929  
+92 52 4264934  
Fax : +92 52 3242929

 +92 336 4770459