



SOFT TECH
SURGICAL

18

Uterine Probes
&
Dressing
Forceps



SOFT TECH Surgical, Manufacturer & Exporter of Quality Instruments

5 mm
Diam. of tip



1/2

MAYO UTERINE PROBE
STRAIGHT MALLEABLE
18-0100
330 mm

4 mm
Diam. of tip



1/2

SIMS UTERINE PROBE
MALLEABLE, CURVED,
GRADUATED
18-0105
330 mm

3,6 mm
Diam. of tip



295 mm

GALABINS, UTERINE
PROBE MALLEABLE,
CURVED, SHAFT
GRADUATED IN CM
18-0110
295 mm

3 mm
Diam. of tip



1/2

MARTIN, UTERINE PROBE
MALLEABLE, GRADUATED
18-0115
300 mm



VALLEIX, UTERINE PROBE
GRADUATED WITH SLIDER
18-0120
250 mm

SIMPSON, UTERINE PROBE
MALLEABLE, GRADUATED,
SILVER PLATED
18-0125
310 mm

BRAUN, UTERINE DEPRESSOR
DOUBLE-ENDED
18-0130
270 mm

SOFT TECH Surgical, Manufacturer & Exporter of Quality Instruments

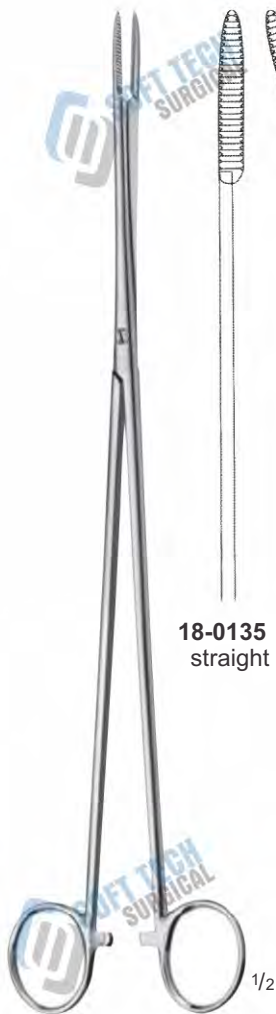

18-0135
straight

18-0136
curved

**PELKMANN UTERINE
DRESSING FORCEPS**
260 mm



**BOZEMANN, UTERINE
DRESSING FORCEPS S-SHAPE**
18-0140
250 mm



**BOZEMANN, UTERINE
DRESSING
FORCEPS S-SHAPE, JAWS
LONGITUDINAL GROOVE**
18-0150
255 mm

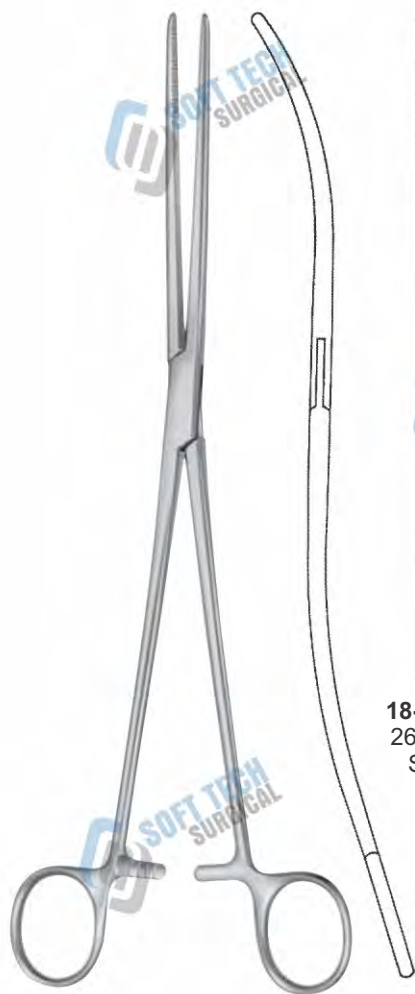

BOZEMANN, UTERINE
DRESSING FORCEPS



18-0155
260 mm
STR

18-0156
250 mm
CVD

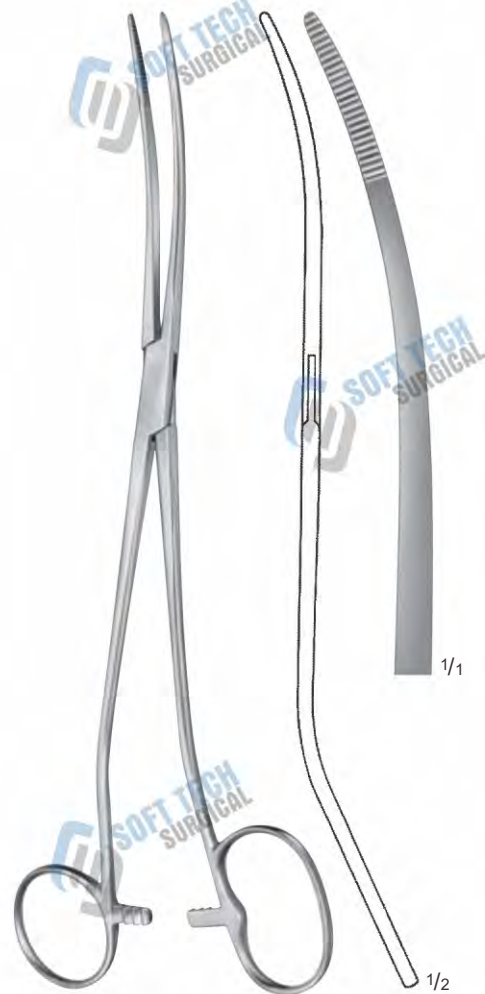

BOZEMANN-DOUGLAS, UTERINE
DRESSING FORCEPS S-SHAPE
18-0160
260 mm

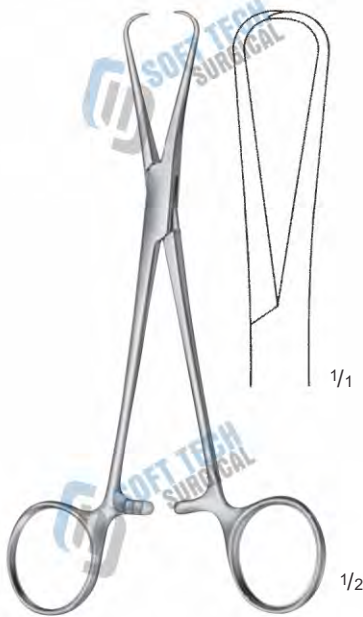

BERNHARD TOWEL CLAMP
18-0165
160 mm



**POZZI, UTERINE
TENACULUM FORCEP**
18-0170
175 mm



**ADAIR, UTERINE
TENACULUM FORCEPS**
18-0175
190 mm



**BRAUN, UTERINE TENACULUM
FORCEPS SLENDER PATTERN**
18-0180
250 mm



**COLLIN- POZZI, UTERINE
TENACULUM FORCEPS**
18-0185
250 mm



**SCHRÖDER UTERINE
TENACULUM FORCEPS
STANDARD PATTERN**
18-0190
250 mm



**SCHRÖDER, UTERINE
TENACULUM FORCEPS**
18-0195
250 mm



**WILSON UTERINE
TENACULUM FORCEPS**
18-0200
240 mm



**POZZI, UTERINE TENACULUM
FORCEPS HEAVY PATTERN**
18-0205
255 mm

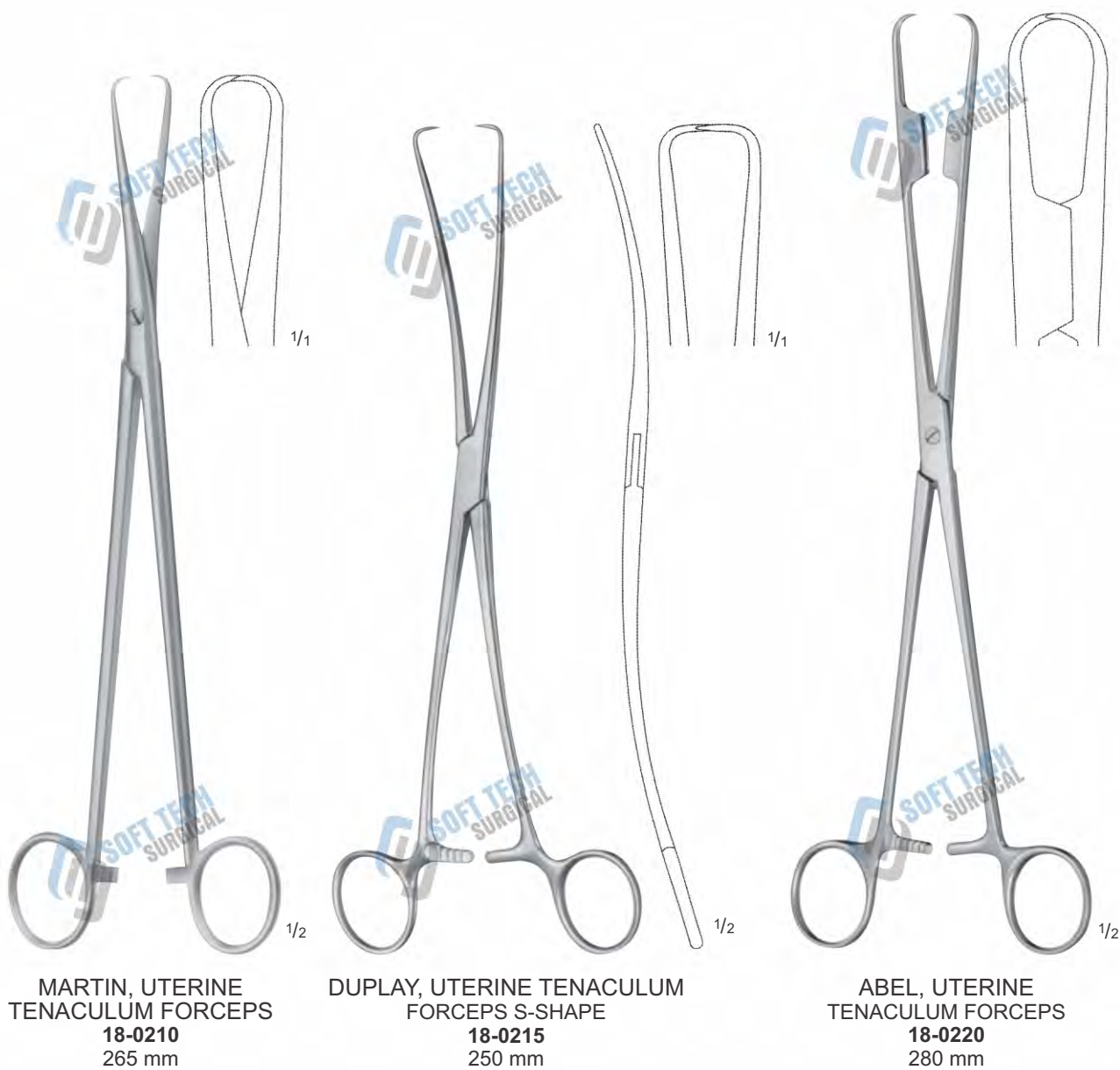

SOFT TECH Surgical, Manufacturer & Exporter of Quality Instruments



**LAHEY TISSUE GRASPING
FORCEPS 2X2 PRONGE**
18-0225
155 mm

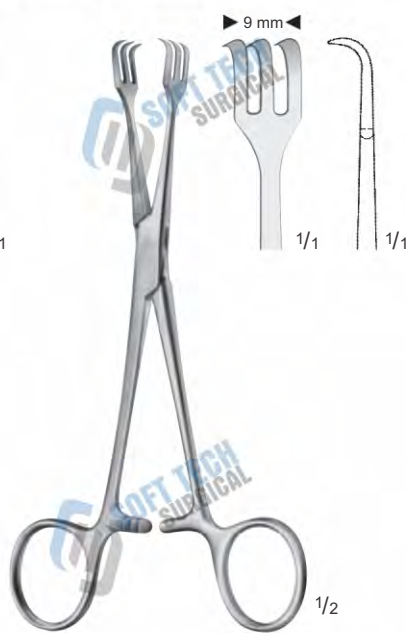

**LAHEY TISSUE GRASPING
FORCEPS 3X3 PRONGE**
18-0230
155 mm

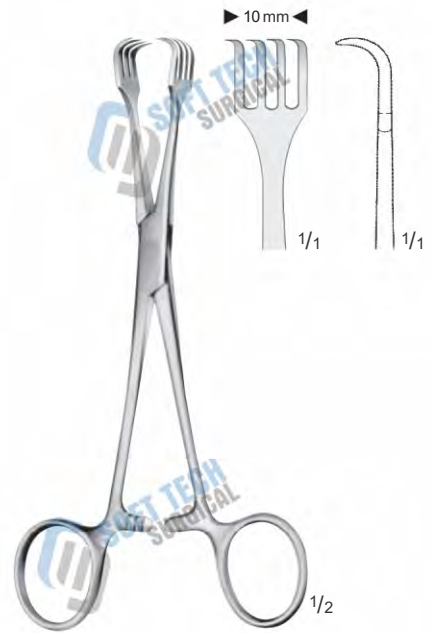

**BRAUN TISSUE GRASPING
FORCEPS 4 x 4 PRONGE**
18-0235
155 mm



**MUSEUX UTERINE TENACULUM
GRASPING FORCEPS**
18-0240
200 mm

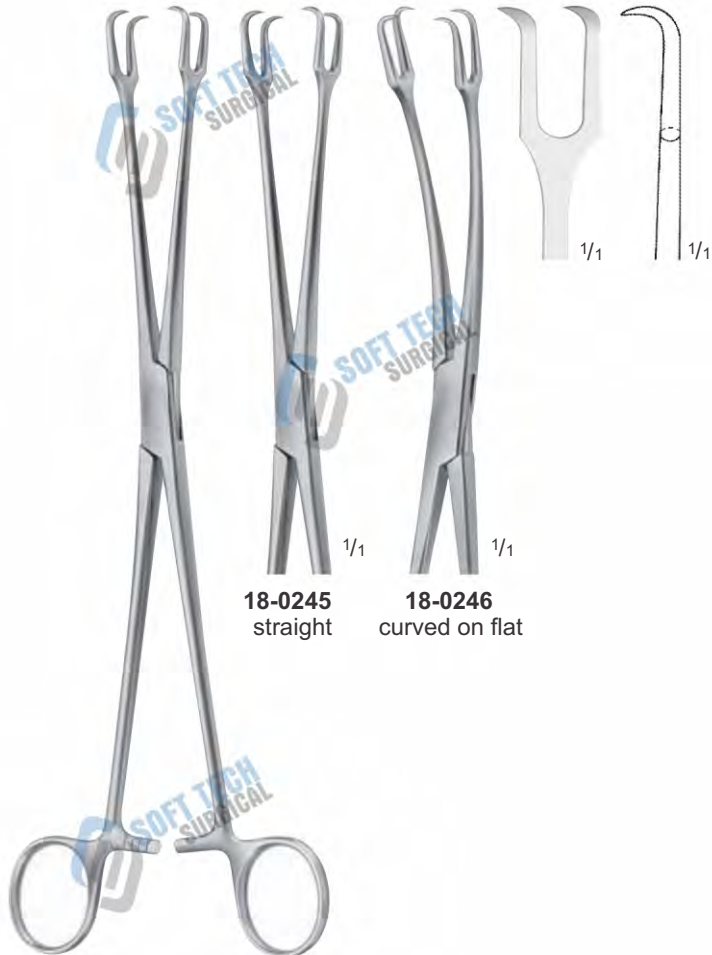

**SCHRÖDER, UTERINE
TENACULUM FORCEPS 2X2 PRONGE**
250 mm

SOFT TECH Surgical, Manufacturer & Exporter of Quality Instruments



**CZERNY, UTERINE TENACULUM
FORCEPS 4 x 4 PRONGE**
18-0250
200 mm

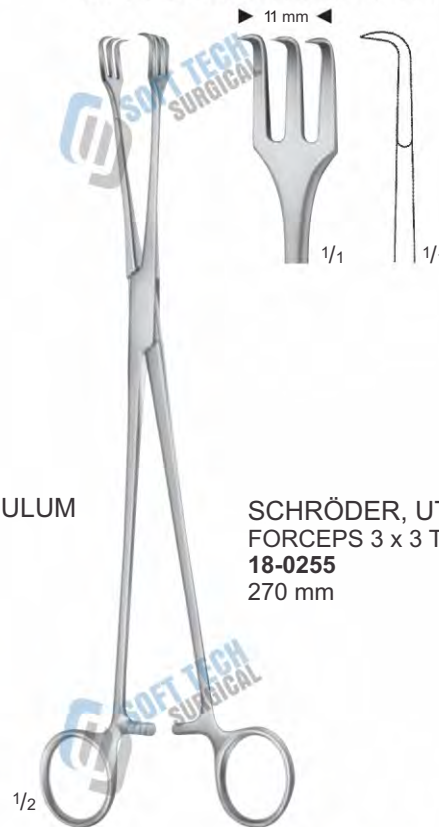

**SCHRÖDER, UTERINE TENACULUM
FORCEPS 3 x 3 TEETH**
18-0255
270 mm



**AESCULAP-PRATT, UTERINE
TENACULUM FORCEPS 4 x 4 PRONGE**
18-0260
260 mm



**PRATT, UTERINE TENACULUM
FORCEPS 4 x 4 PRONGE**
18-0265
270 mm

SOFT TECH Surgical, Manufacturer & Exporter of Quality Instruments



**KÜSTNER, UTERINE
TENACULUM FORCEPS**
2X3 TEETH
18-0270
250 mm



**TEALE, UTERINE
TENACULUM FORCEPS**
3 x 4 TEETH
18-0275
180 mm



**TEALE, UTERINE TENACULUM
FORCEPS 3X4 TEETH,
ANGLED TO SIDE**
18-0280
255 mm



**JACOBS, UTERINE
TENACULUM
FORCEPS 2X2 TEETH**
18-0285
215 mm

LITTLEWOOD UTERINE
TENACULUM FORCEPS
2X3 TEETH
18-0290
185 mm



MUSEUX UTERINE
TENACULUM FORCEPS
2X2 TEETH
18-0295
200 mm

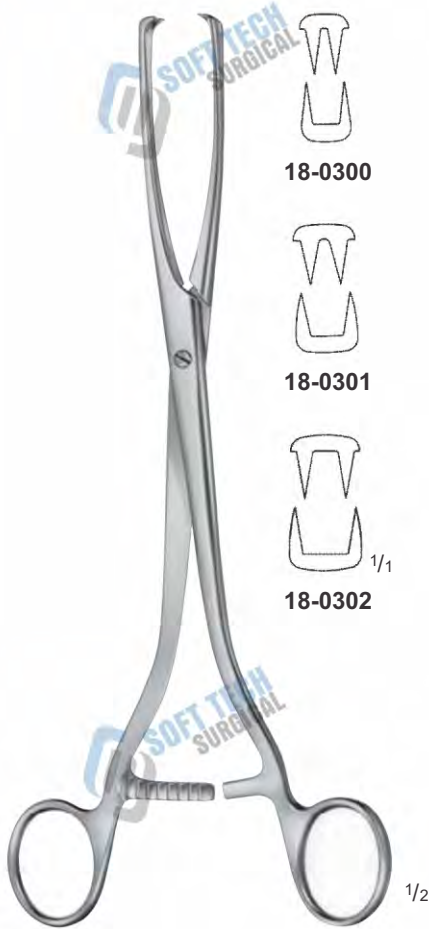

MUSEUX UTERINE TENACULUM
FORCEPS 2X2 TEETH
240 mm

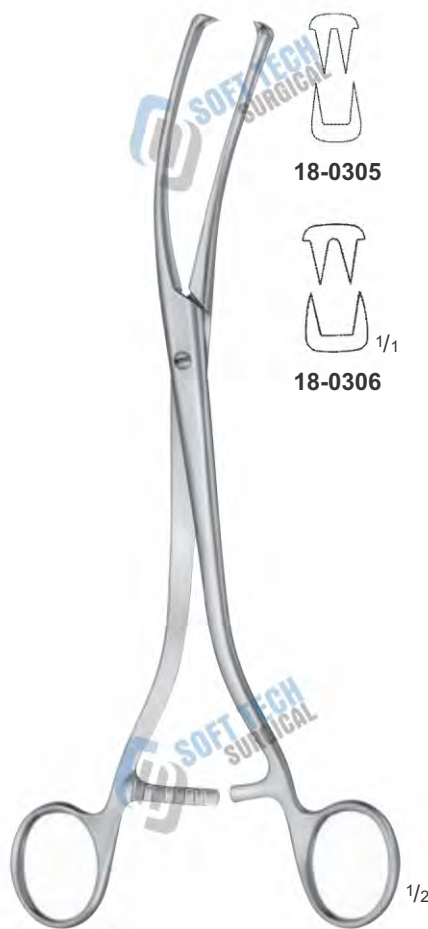

MUSEUX, UTERINE TENACULUM
FORCEPS 2X2 TEETH, SIDE CURVED
240 mm

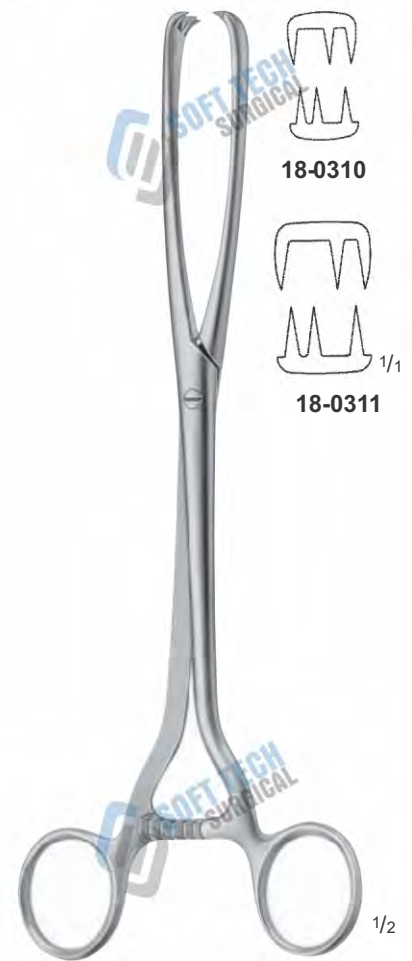

MUSEUX, UTERINE TENACULUM
FORCEPS 3X3 TEETH
265 mm



HEYWOOD-SMITH SPONGE
HOLDING GRASPING FORCEPS
18-0315
200 mm

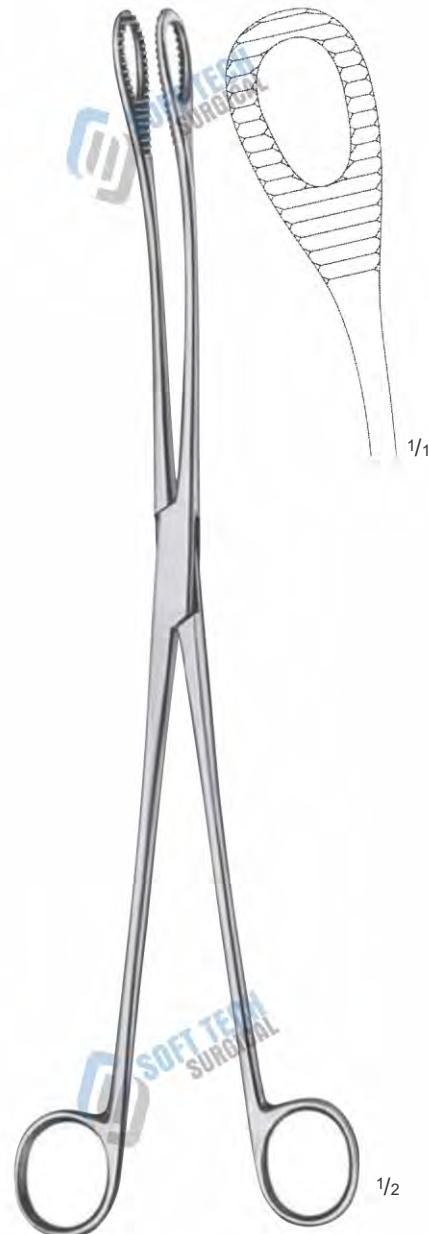

KELLY SPONGE HOLDING GRASPING
FORCEPS CURVED, WITHOUT RATCHET
18-0320
320 mm

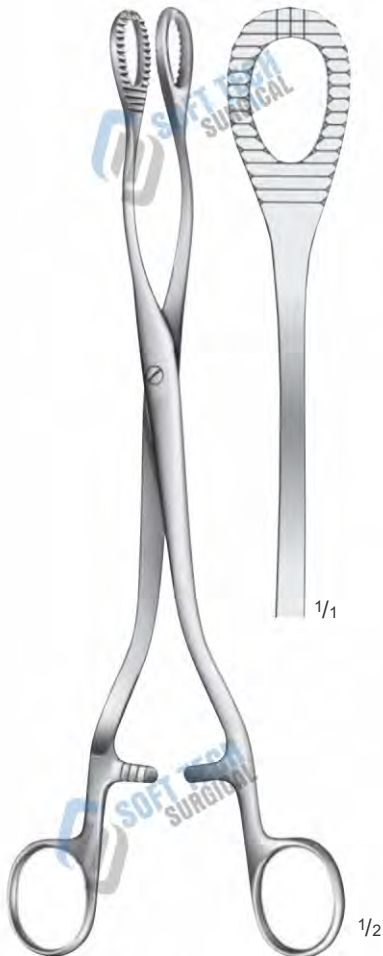

HEYWOOD-SMITH SPONGE
HOLDING GRASPING FORCEPS
18-0325
250 mm

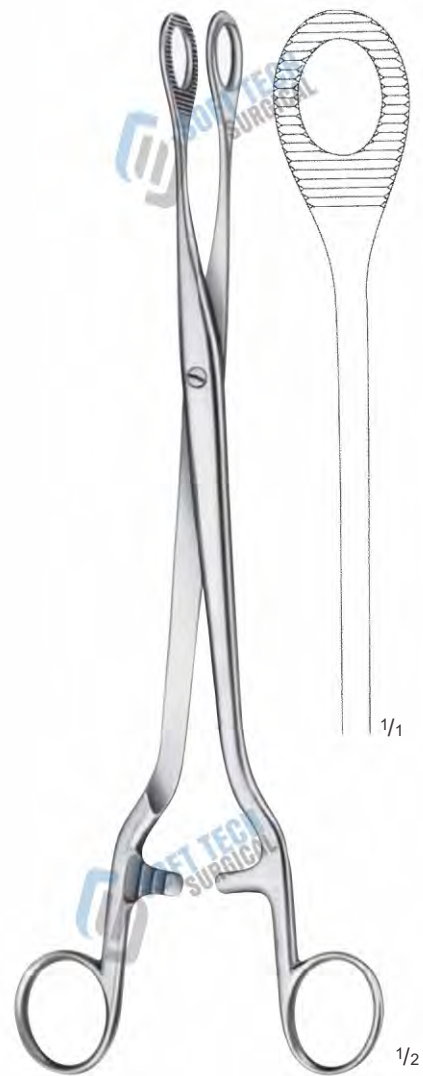

NOTO SPONGE HOLDING
GRASPING FORCEPS
18-0330
280 mm



**DOYEN POLYPUS
BLADDER FORCEP**
18-0335
185 mm



18-0340
250 mm

18-0341
270 mm

**ATRAUMATA POLYPUS
OVUM FORCEPS**

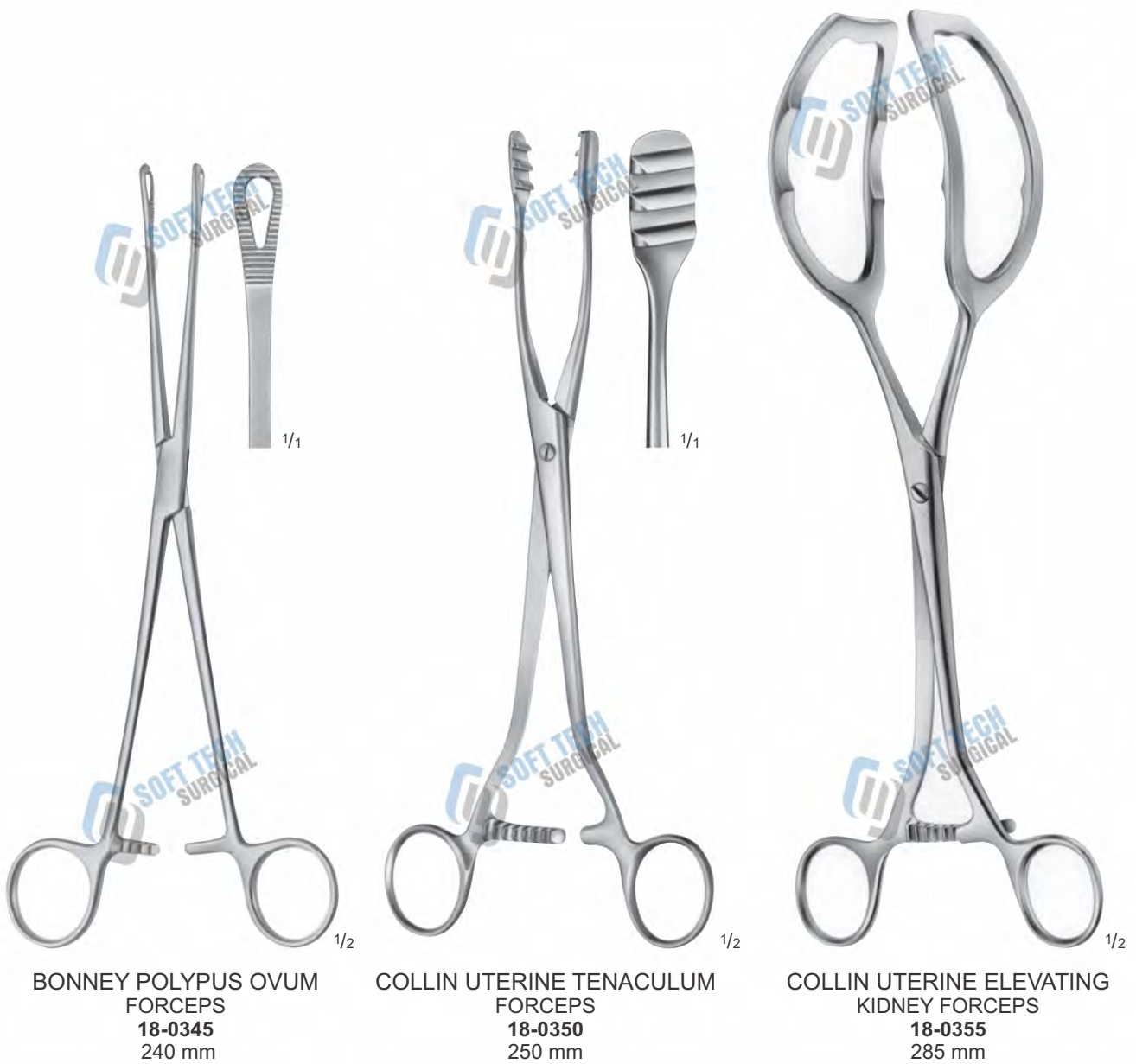

with movable jaws



**DARTIGUES UTERINE ELEVATING
KIDNEY FORCEPS**
18-0360
255 mm



**SOMMER, UTERINE ELEVATING
FORCEPS CURVED**
18-0365
235 mm



**COLLIN UTERINE ELEVATING
FORCEPS**
18-0370
265 mm



DOYEN, MYOMA SCREW
18-0375
150 mm



DOYEN, MYOMA SCREW
18-0380
190 mm



UCHIDA (MODIF. N. BURKE) SPOON

18-0385 270 mm
18-0386 350 mm



18-0390 235 mm
18-0391 350 mm

KIEBACK URETERAL TUNNEL
CLAMP CURVED TO SIDE

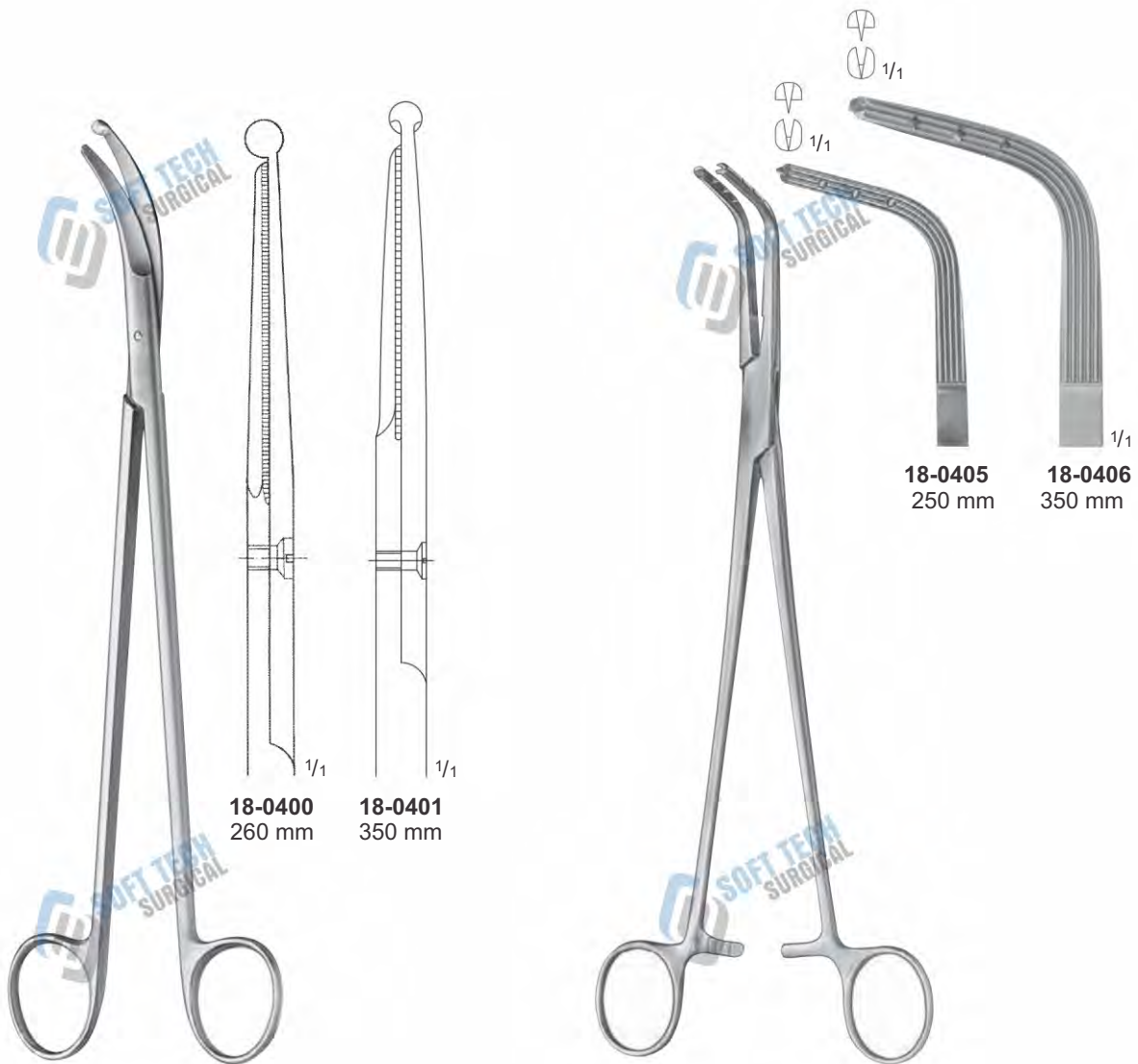

**KIEBACK PARAMETRIUM
SCISSORS CURVED, PROBE
POINTED, ONE BLADE
SERRATED**

**BURKE HYSTERECTOMY
FORCEPS
PARAMETRIUM, SHORT JAWS**



BURKE HYSTERECTOMY
FORCEPS PARAMETRIUM,
LONG JAWS

18-0410
250 mm



BURKE HYSTERECTOMY
FORCEPS PARAMETRIUM,
LONG JAWS

18-0415
350 mm



**KIEBACK PARAMETRIUM
SCISSORS 90° ANGLED**

18-0420
240 mm



**KIEBACK PARAMETRIUM
SCISSORS 90° ANGLED**

18-0425
350 mm



**SOFT TECH
SURGICAL**

General Surgery Instruments Catalogue

SOFT TECH Surgical

Muslim Town, Airport Road
Kotli Behram, Sialkot 51310
Pakistan.

Email : info@softtechsurgical.com
Website : www.softtechsurgical.com

Phone : +92 52 3573488
+92 52 3242929
+92 52 4264934
Fax : +92 52 3242929

 +92 336 4770459