



SOFT TECH
SURGICAL

11
Wound
Retractors



SOFT TECH Surgical, Manufacturer & Exporter of Quality Instruments

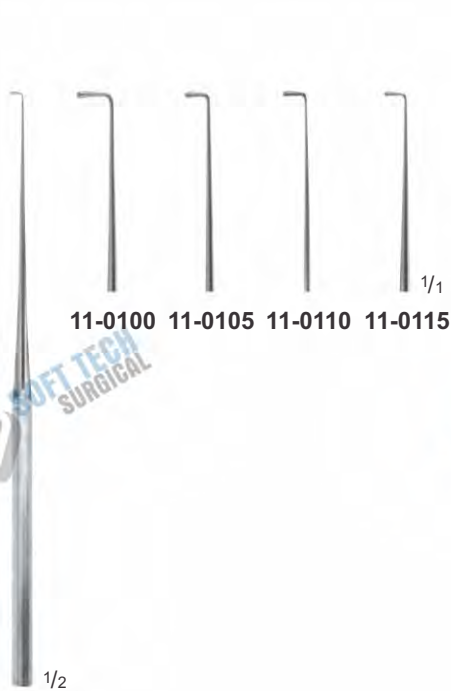

WAGENER EAR HOOK
PROBE ENDED
150 mm



GRAEFE STRABISMUS
HOOK
140 mm



ST. BARTS EAR
HOOK BLUNT
11-0135
180 mm



BROM VEIN RETRACTOR
11-0140
170 mm



CRILE
11-0145
200 mm



CUSHING
190 mm

SOFT TECH Surgical, Manufacturer & Exporter of Quality Instruments



KRAYENBÜHL
NERVE HOOK
185 mm



ADSON NERVE
HOOK
190 mm

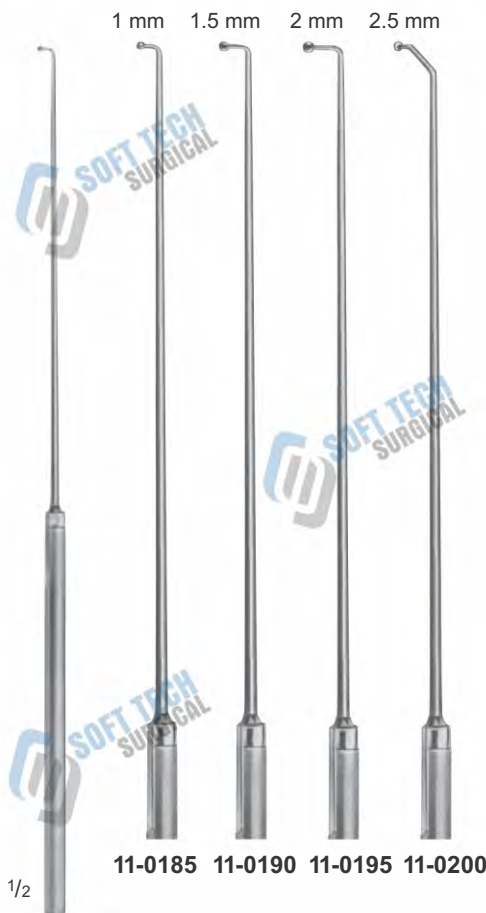

CASPAR EXPLORATION-
COAGULATION HOOK
245 mm



CUSHING NERVE
HOOK
11-0205
280 mm

SOFT TECH Surgical, Manufacturer & Exporter of Quality Instruments

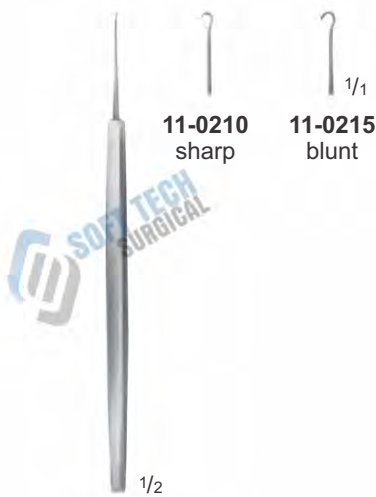

**GRAEFE GRAEFE
IRIS HOOK**
125 mm



**GUTHRIE GUTHRIE
IRIS HOOK SHARP**

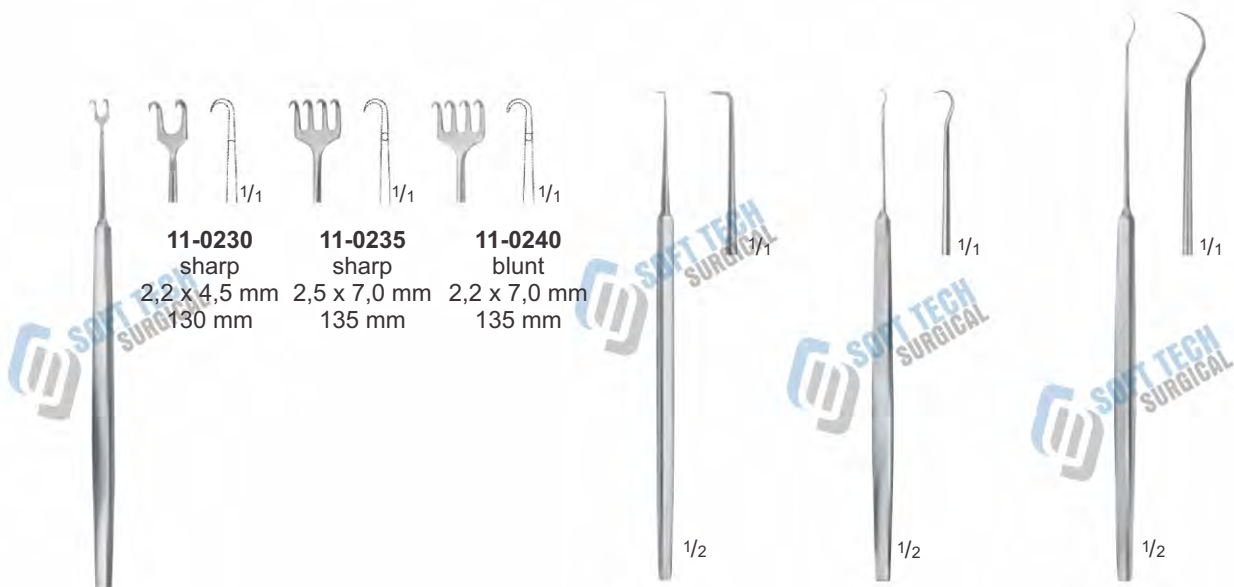

ROLLET ROLLET IRIS HOOK

**CAIRNS DURA
HOOK**
11-0245
130 mm

**FRAZIER DURA
HOOK**
11-0250
130 mm

**TOENNIS DURA
HOOK**
11-0255
150 mm



KILNER SKIN
HOOK
11-0260
160 mm



MC INDOE SKIN
RETRACTOR
150 mm



11-0266
Sharp



FREER SKIN
RETRACTOR
11-0270
150 mm



MÜLLER SKIN
RETRACTOR WITH
BALL
11-0275
150 mm



MÜLLER SKIN
RETRACTOR
WITH BALL
11-0280
150 mm



COTTLE SKIN
RETRACTOR
11-0285
160 mm



COTTLE SKIN
RETRACTOR
11-0290
160 mm



KLEINERT-KUTZ
SKIN HOOK
160 mm

SOFT TECH Surgical, Manufacturer & Exporter of Quality Instruments



**JAEGER STRABISMUS
HOOK**
11-0300
135 mm

JOSEPH SKIN RETRACTOR
165 mm

**GILLIES SKIN
RETRACTOR**
180 mm

General Surgery
Instruments
Fine Wound Retractors, Dura & Skin
Retractors, & Trachea Retractors



SOFT TECH Surgical, Manufacturer & Exporter of Quality Instruments



**BARSKY SKIN
RETRACTOR**
11-0325
155 mm

**DURA
RETRACTOR**
11-0330
185 mm

**FISCH DURA
RETRACTOR**
11-0335
185 mm

**KILNER ALAR
RETRACTOR**
11-0340
80 mm

**CONVERSE DOUBLE
HOOK**
11-0345
120 mm

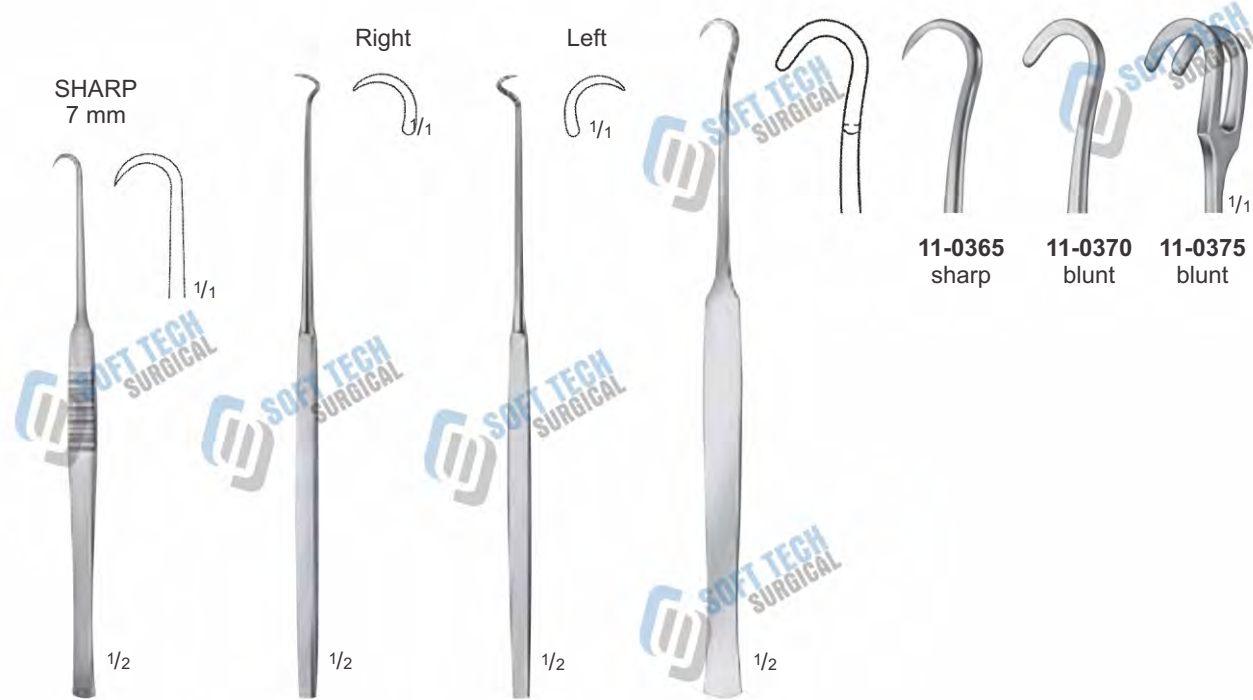

**BERGMANN
RETRACTOR**
11-0350
140 mm

**BOSE
RETRACTOR**
11-0355
165 mm

**BOSE
RETRACTOR**
11-0360
165 mm

**TRACHEA
RETRACTOR**
180 mm

SOFT TECH Surgical, Manufacturer & Exporter of Quality Instruments



11-0380
3.5 x 4.5 mm
Sharp

1/2

WOUND RETRACTOR
FLEXIBLE SHAFT
155 mm



11-0385
4.0 x 7.2 mm
Sharp



11-0390
4.0 x 1.0 mm
Sharp



11-0345
4.0 x 4.5 mm
Blunt

1/2

WOUND RETRACTOR
FLEXIBLE SHAFT
155 mm



11-0400
4.0 x 7.5 mm
Blunt



11-0405
4.0 x 10.2 mm
Blunt



11-0410
5.0 x 4.2 mm
Sharp

1/2

RETRACTOR
SMALL CURVE
165 mm



11-0415
5.0 x 7.0 mm
Sharp



11-0420
5.0 x 7.0 mm
Sharp



11-0425
5.0 x 9.5 mm
Sharp

1/1



11-0430
4.5 x 4.2 mm
Blunt

1/2

RETRACTOR
SMALL CURVE
165 mm



11-0435
4.5 x 7.0 mm
Blunt



11-0440
4.5 x 7.0 mm
Blunt



11-0445
4.5 x 9.5 mm
Blunt

1/1



WOUND TRACHEAL
RETRACTOR LARGE CURVE
165 mm

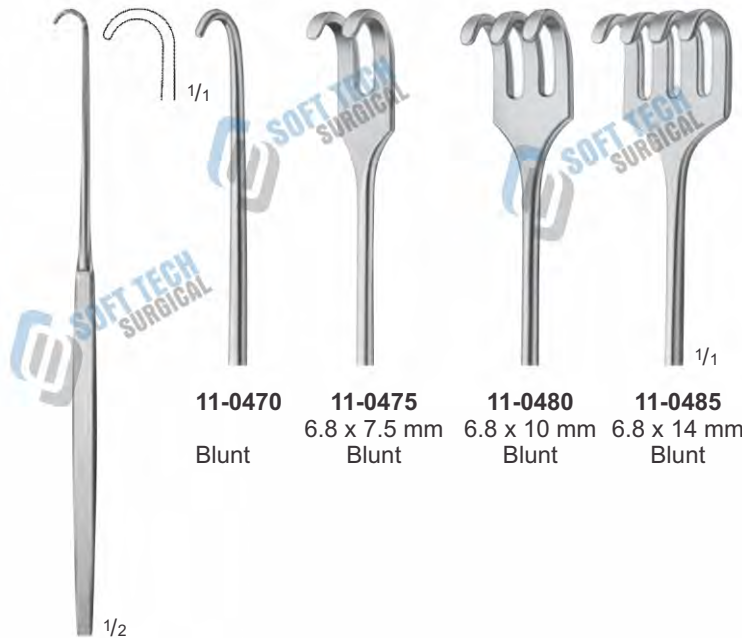

WOUND TRACHEAL
RETRACTOR LARGE CURVE
165 mm

SOFT TECH Surgical, Manufacturer & Exporter of Quality Instruments



MANNERFELT
MODIF. RETRACTOR
11-0490
135 mm

MANNERFELT
MODIF. RETRACTOR
11-0495
155 mm

MANNERFELT
MODIF. RETRACTOR
11-0500
155 mm

MANNERFELT MODIF.
FORKED HOOK forked
hooks
155 mm



MANNERFELT MODIF. RETRACTOR
SMALL CURVE
155 mm

MANNERFELT MODIF. RETRACTOR
LARGE CURVE
155 mm



MANNERFELT MODIF.
RETRACTOR SMALL CURVE
FLEXIBLE SHAFT
11-0550
155 mm

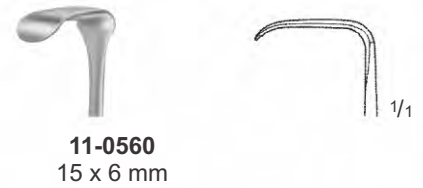

11-0560
15 x 6 mm



11-0561
20 x 6 mm



16 x 6 mm



MANNERFELT MODIF.
RETRACTOR HOLLOW
GROOVED
11-0555
155 mm



11-0562
25 x 6 mm



11-0563
30 x 8 mm



LANGENBECK- MANNERFELT
MODIF. RETRACTOR .
155 mm

SOFT TECH Surgical, Manufacturer & Exporter of Quality Instruments

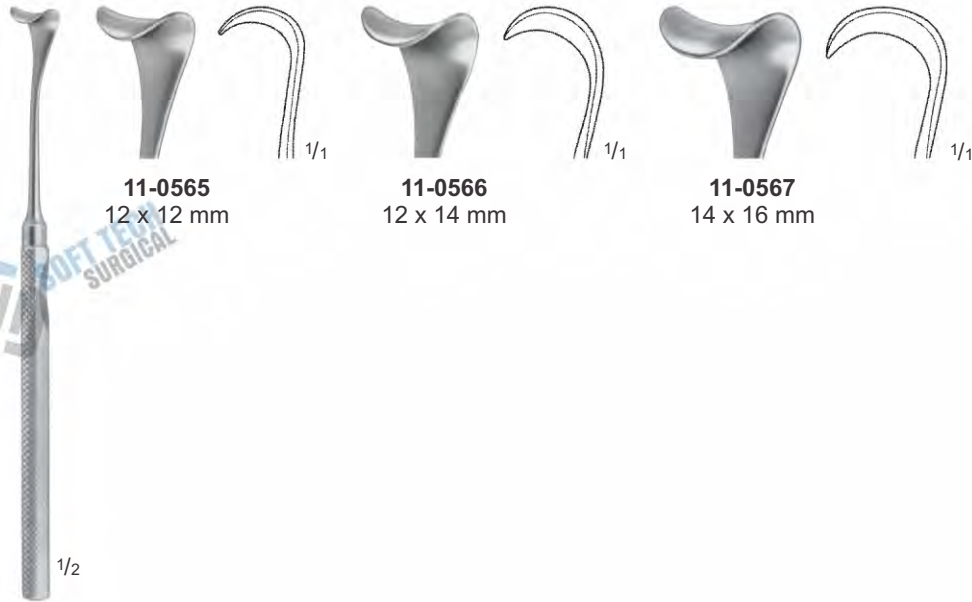

**MANNERFELT MODIF.
SADDLE HOOK**
155 mm



**MANNERFELT MODIF.
SADDLE HOOK
FENESTRATED**
11-0570
155 mm



**MANNERFELT
MODIF. TEBDON
DOUBLE HOOK**
11-0575
160 mm



**MANNERFELT MODIF.
SPATULA DOUBLE-
ENDED**
11-0580
160 mm



FOMON ALAR.
RETRACTOR
BLUNT/BLUNT
11-0585
145 mm

RETRACTOR
SHARP PRONG
160 mm

LANGENBECK- GREEN
RETRACTOR
160 mm

RETRACTOR SADDLE-
SHAPED
11-0600
160 mm



MEYERDING
RETRACTOR
180 mm



Fig. A
11-0605
18 x 7 mm



Fig. B
11-0610
16 x 5 mm

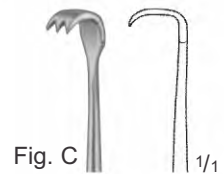

Fig. C
11-0615
7 x 4 mm



Fig. D
11-0620
5 x 10 mm



Fig. E
11-0625
11 x 4 mm

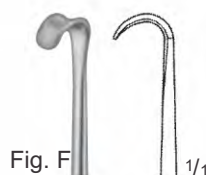

Fig. F
11-0630
6 x 4 mm

SOFT TECH Surgical, Manufacturer & Exporter of Quality Instruments



**EMMET FISTULA
HOOK**
11-0635
220 mm



**SIMON FISTULA
HOOK**
11-0640



**SIMON FISTULA
HOOK**
11-0645
220 mm



**LANGE FISTULA
HOOK**
11-0650
235 mm



PAUL TENDON
HOOK IRIS HOOK
11-0655
120 mm

TENDON HOOK
175 mm

KLAPP TENDON
HOOK
11-0665
175 mm

STRANDELL-STILLE
TENDON HOOK
180 mm



MASING
ALAR-RETRACTOR
11-0680
140 mm

COTTLE ALAR
RETRACTOR
11-0685
140 mm

DESMARRES RETRACTOR
140 mm

SOFT TECH Surgical, Manufacturer & Exporter of Quality Instruments



11-0700
13 x 13 mm



11-0701
12 x 16 mm



10 x 10 mm



11-0710
20 x 12 mm



11-0711
20 x 15 mm



1/2



1/2



1/2

KÖNIG RETRACTOR
180 mm

**CUSHING- KOCHER
RETRACTOR**
11-0705
175 mm

KOCHER RETRACTOR
205 mm



13 x 6 mm



11-0720
10 x 13 mm



11-0721
14 x 18 mm

20 x 15 mm



1/2

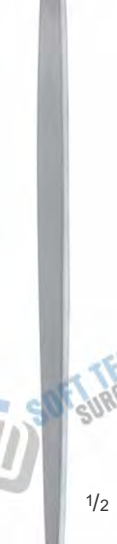

1/2



20 x 19 mm

1/2

**SCHÖNBORN
RETRACTOR**
11-0715
200 mm

CUSHING RETRACTOR
205 mm

RETRACTOR DUBLE ENDED
11-0725
205 mm



CUSHING RETRACTOR
250 mm



DISSECTION HOOK,
BLUNT
11-0735
235 mm

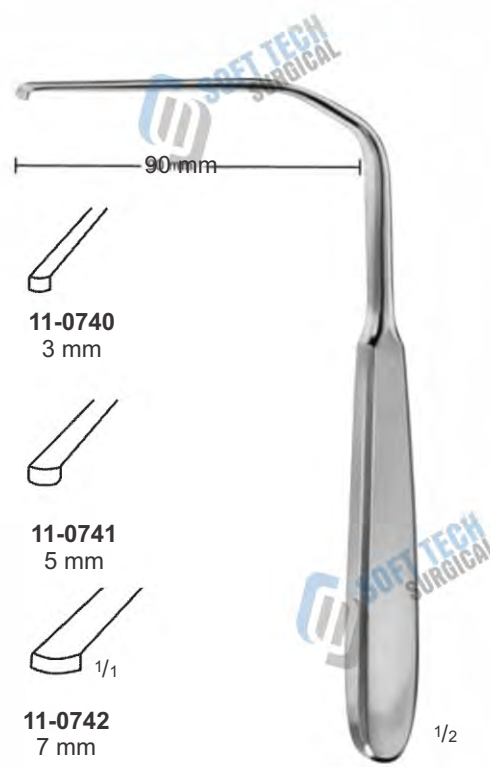

HESS NERVE ROOT
RETRACTOR
175 mm

SOFT TECH Surgical, Manufacturer & Exporter of Quality Instruments

6 x 10 mm



13 x 5 mm

**KILNER RETRACTOR
DOUBLE-ENDED
11-0745
155 mm**



**11-0750
8 x 7 mm
Sharp**



**11-0755
8 x 7 mm
Blunt**



22 x 7 mm

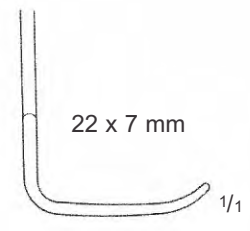

22 x 7 mm

**BABY-SENN-MILLER
RETRACTOR DOUBLE-ENDED
155 mm**

8 x 7 mm



18 x 5,5 mm

**SENN-MILLER RETRACTOR
DOUBLE-ENDED
11-0760
165 mm**



**COLLIN- HARTMANN
RETRACTOR
11-0765
150 mm**



**11-0770
120 mm**

**11-0771
130 mm**

**11-0772
135 mm**

**STERNBERG CHEEK
RETRACTOR**



**LUER RETRACTOR
DOUBLE-ENDED**
11-0775
110 mm



**ROSE RETRACTOR
DOUBLE-ENDED**
11-0780
130 mm



**BABY-ROUX RETRACTOR
DOUBLE-ENDED**
11-0785
135 mm



**PARKER RETRACTOR
DOUBLE-ENDED**
11-0790
135 mm



**RAGNELL RETRACTOR
DOUBLE-ENDED**
11-0795
150 mm



**CRILE RETRACTOR
DOUBLE-ENDED**
11-0800
110 mm



**FARABEUZ RETRACTOR
DOUBLE ENDED**
11-0805
125 mm



**FARABEUZ RETRACTOR
DOUBLE-ENDED**
11-0810
150 mm

SOFT TECH Surgical, Manufacturer & Exporter of Quality Instruments

36 x 44 mm
30 x 24 mm



36 x 44 mm
30 x 24 mm

**PARKER RETRACTOR
DOUBLE ENDED
11-0815
180 mm**

21 x 14 mm
17 x 14 mm



28 x 16 mm
32 x 16 mm

**COLLIN RETRACTOR
DOUBLE-ENDED
11-0820
150 mm**

Set complete,



**ROUX RETRACTOR
DOUBLE-ENDED
165 mm**

19 x 22 mm

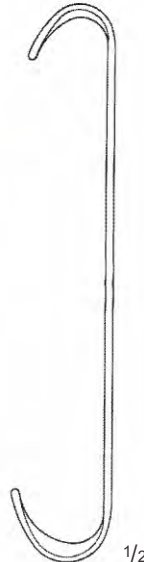

23 x 30 mm
11-0825

25 x 26 mm

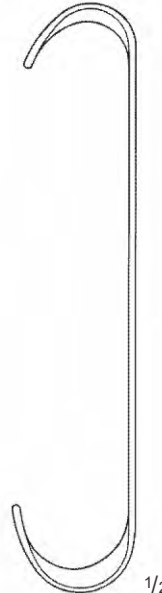

28 x 38 mm
11-0826

28 x 29 mm

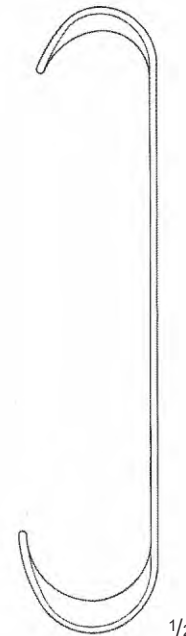

33 x 45 mm
11-0827

SOFT TECH Surgical, Manufacturer & Exporter of Quality Instruments

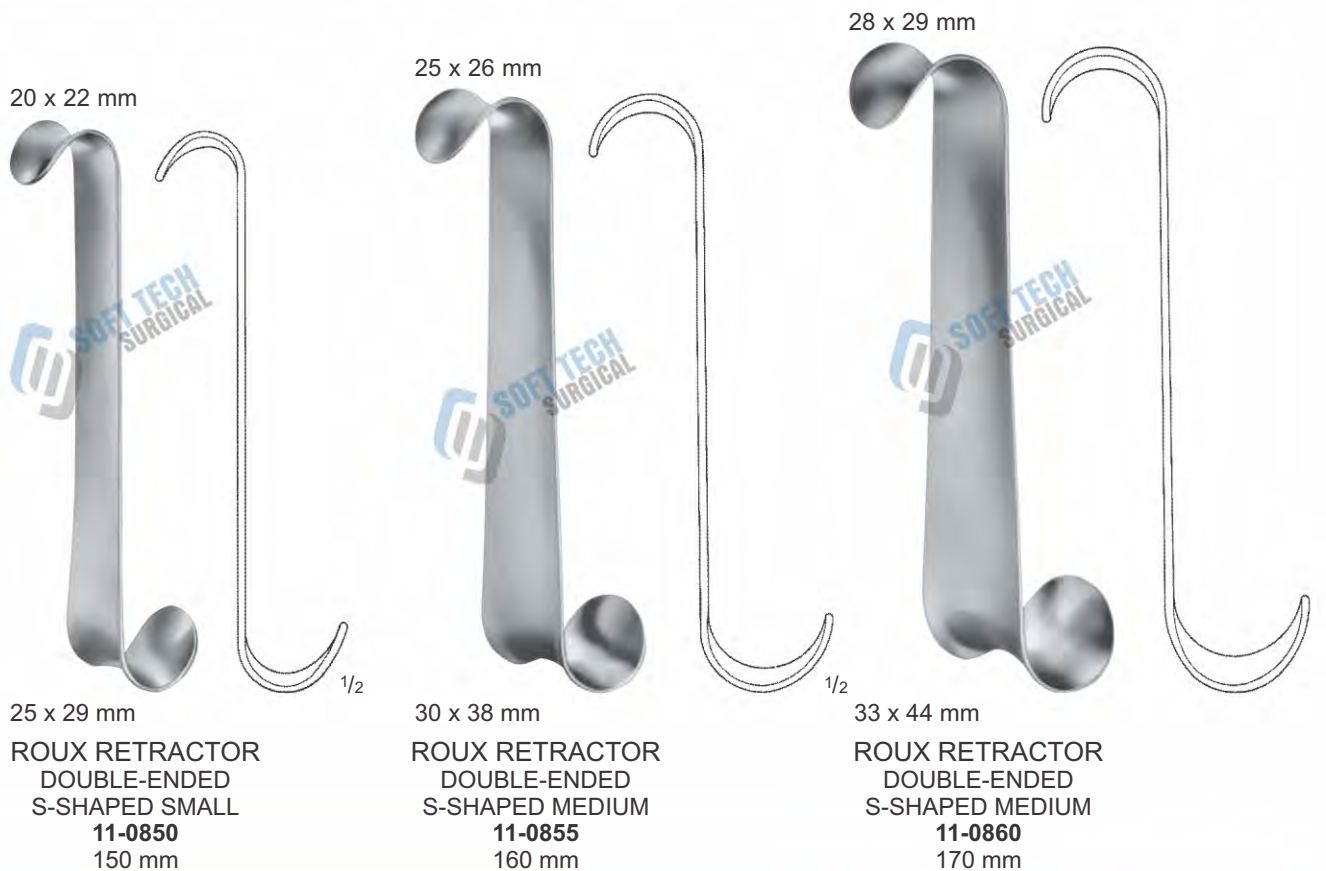

SOFT TECH Surgical, Manufacturer & Exporter of Quality Instruments

30 x 13 mm



35 x 19 mm

**LANE RETRACTOR
DOUBLE-ENDED**
11-0865
230 mm

30 x 25 mm



35 x 32 mm

**LANE RETRACTOR
DOUBLE-ENDED**
11-0870
230 mm

38 x 22 mm



38 x 22 mm

**CZERNY RETRACTOR
DOUBLE-ENDED**
11-0875
175 mm

30 x 18 mm

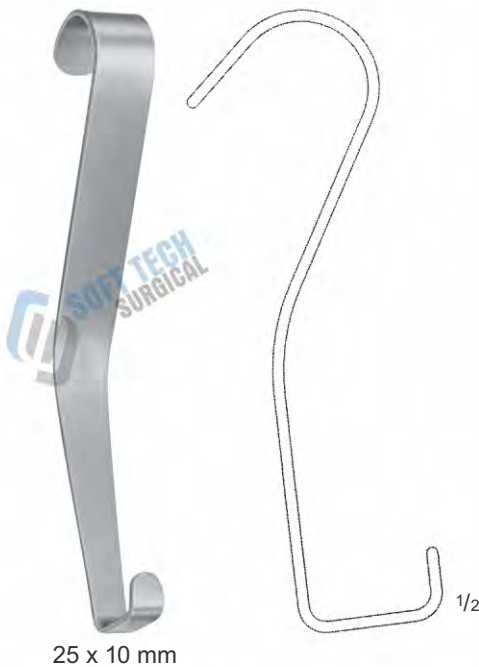

25 x 10 mm

HAJEK RETRACTOR
11-0880
165 mm

47 x 13 mm

41 x 13 mm

38 x 22 mm



37 x 25 mm
45 x 25 mm

38 x 22 mm

**MATHIEU RETRACTOR
DOUBLE-ENDED, SET OF 2**
11-0885
200 mm

26 x 15 mm
22 x 15 mm

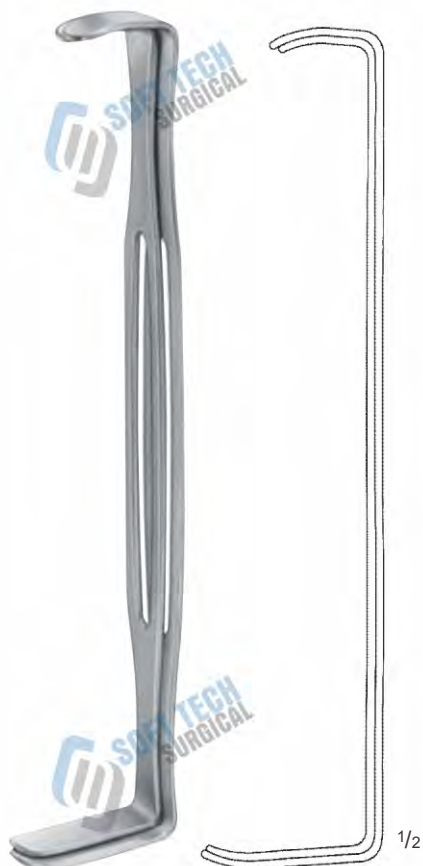

39 x 15 mm
43 x 15 mm

US-ARMY RETRACTOR
DOUBLE-ENDED
11-0890
220 mm



GOELET RETRACTOR
DOUBLE-ENDED
11-0895
190 mm



CANNY- RYALL
RETRACTOR

WIDTH OF BLADE	Blade width
11-0900 190 mm	16 mm
11-0901 190 mm	20 mm
11-0902 200 mm	25 mm

SOFT TECH Surgical, Manufacturer & Exporter of Quality Instruments

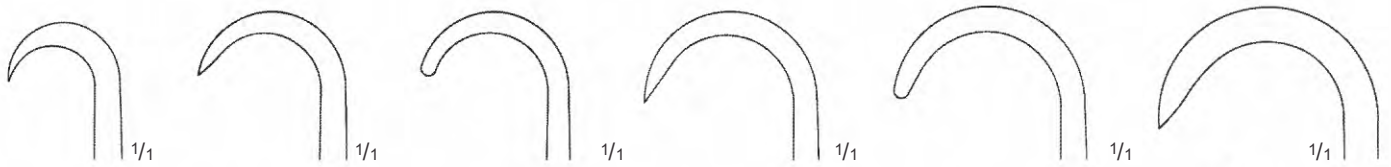

**KOCHER
RETRACTOR
11-0905**
sharp
205 mm

**KOCHER
RETRACTOR
11-0910**
sharp
220 mm

**KOCHER
RETRACTOR
11-0915**
blunt
220 mm

**VOLKMANN
RETRACTOR
11-0920**
sharp
220 mm

**VOLKMANN
RETRACTOR
11-0925**
blunt
220 mm

**RETRACTOR
11-0930**
sharp
245 mm

SOFT TECH Surgical, Manufacturer & Exporter of Quality Instruments

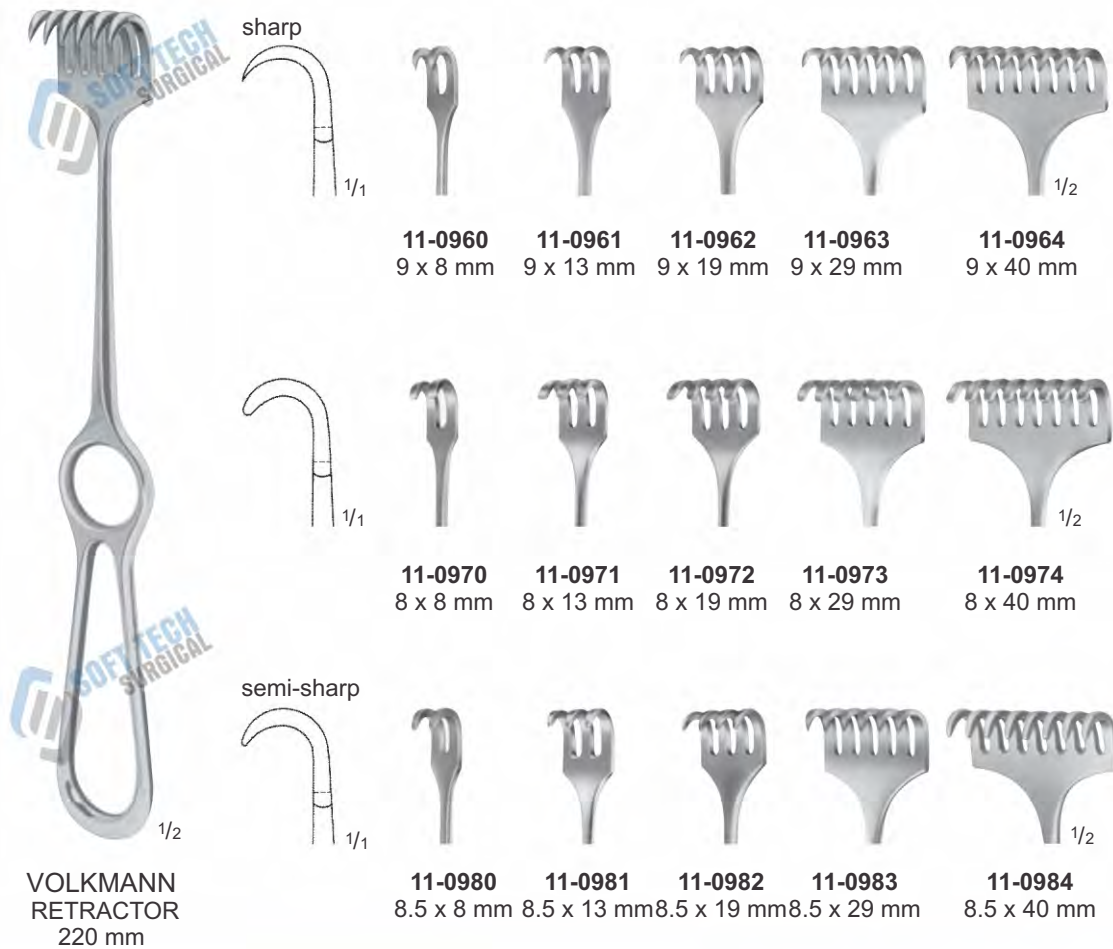
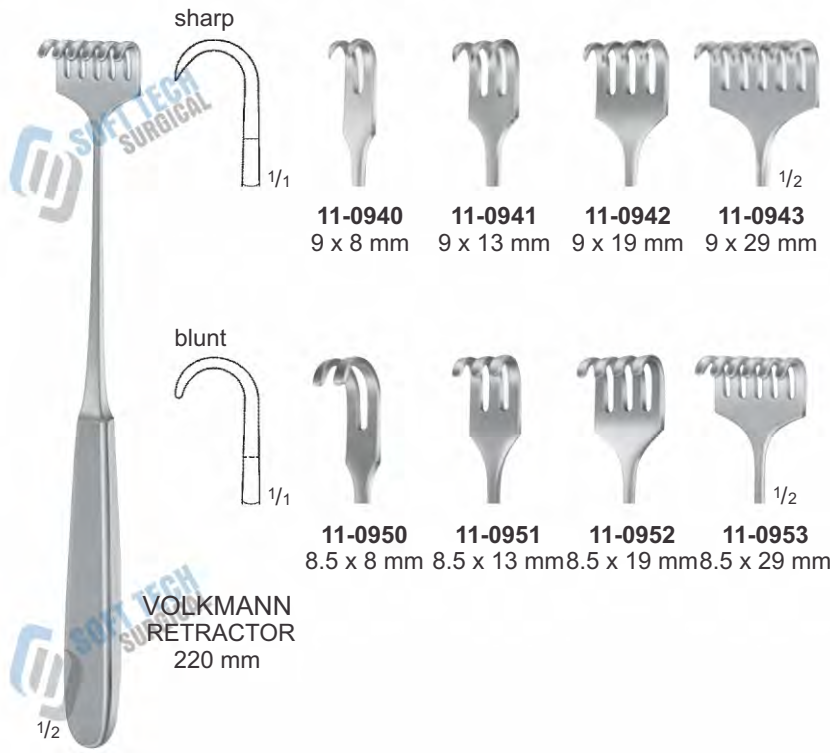

SOFT TECH Surgical, Manufacturer & Exporter of Quality Instruments

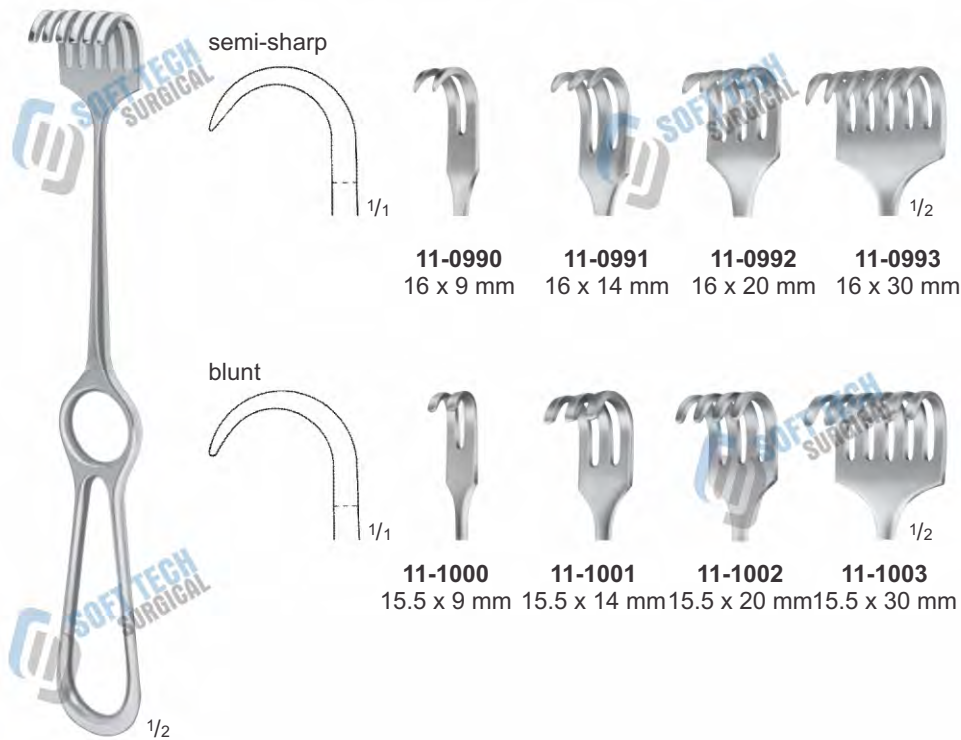

KOCHER RETRACTOR
220 mm



MURPHY RETRACTOR
195 mm

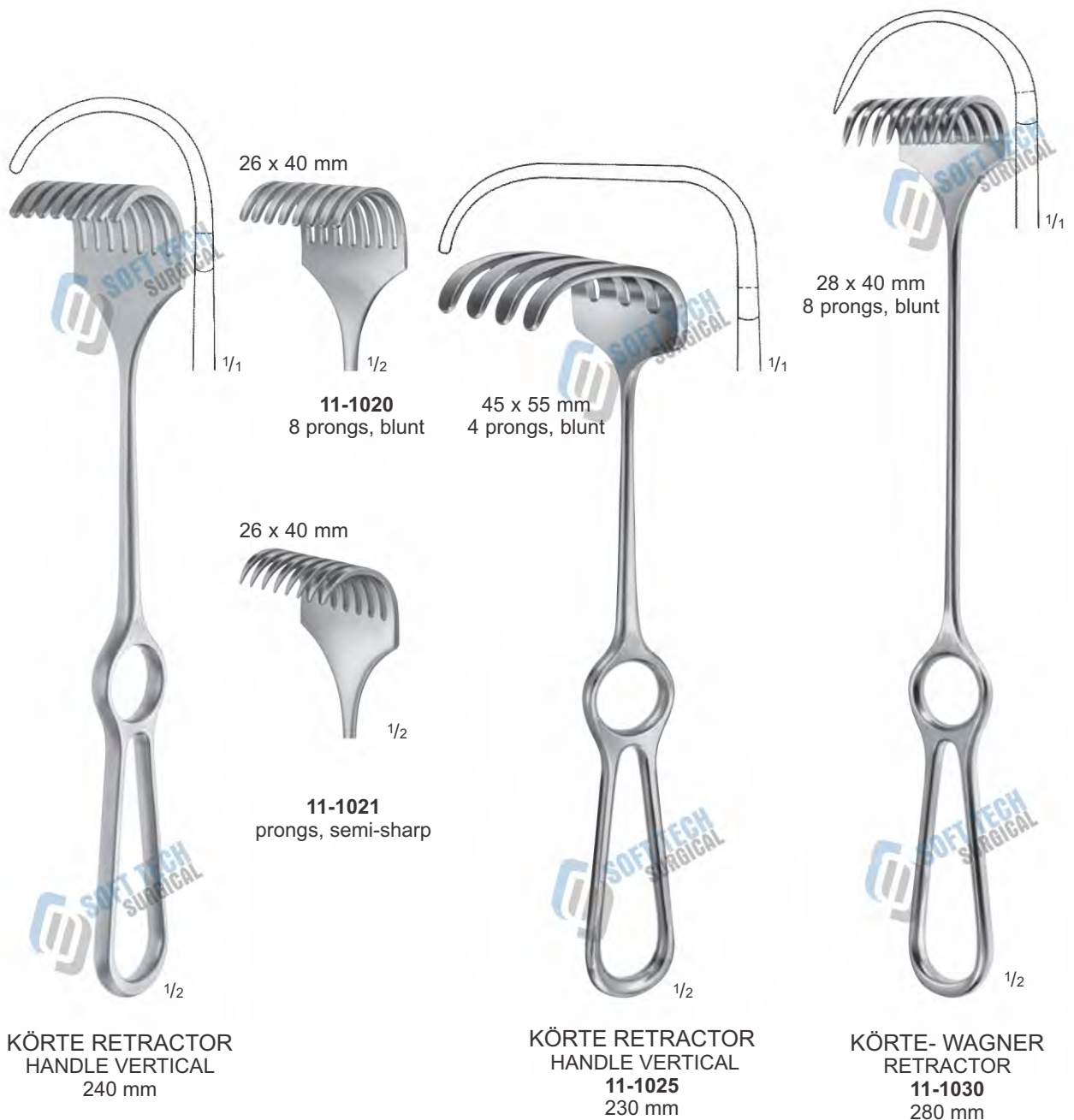

SOFT TECH Surgical, Manufacturer & Exporter of Quality Instruments

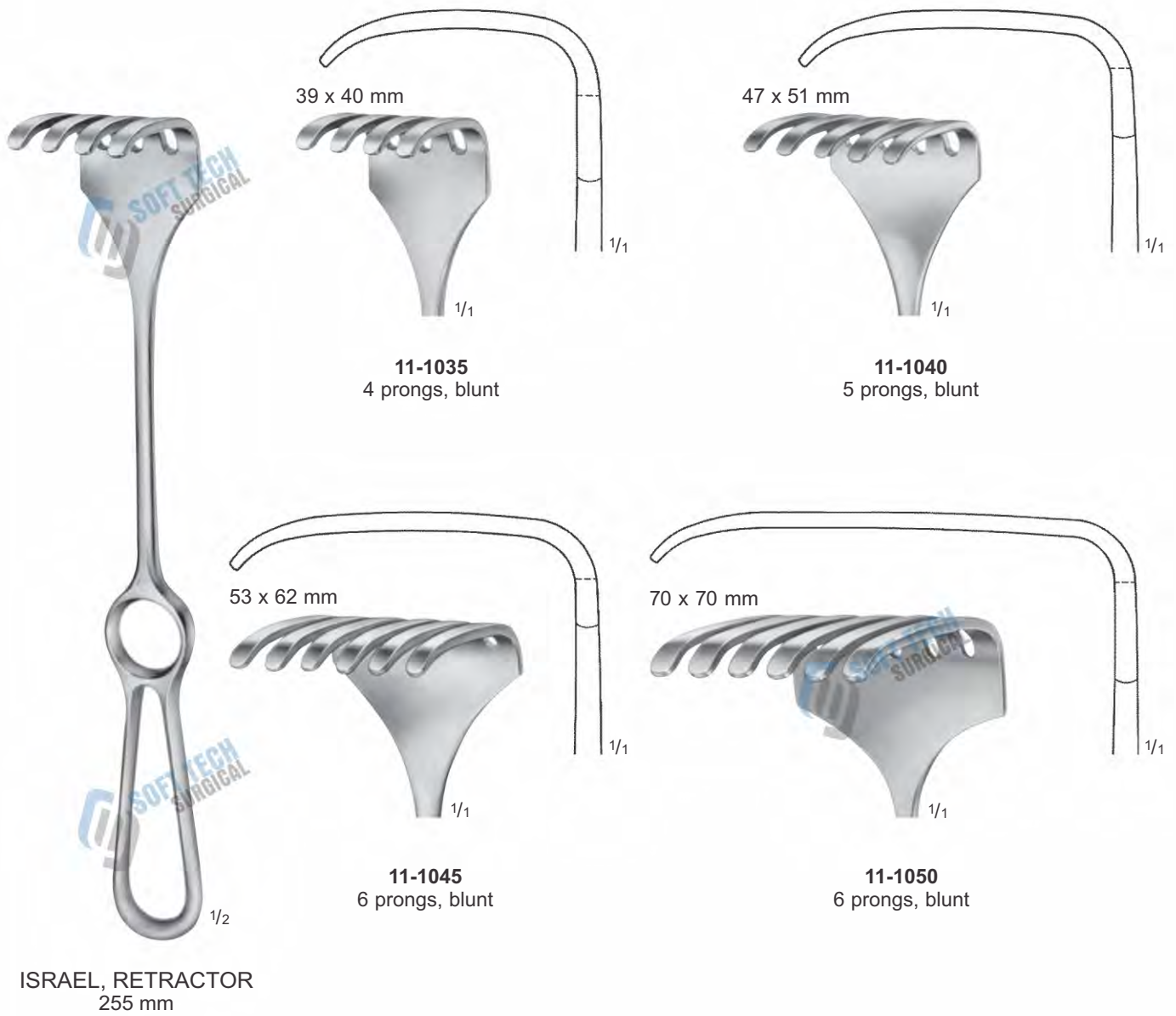



OLLIER RETRACTOR
11-1055
230 mm



11-1060
30 x 10 mm

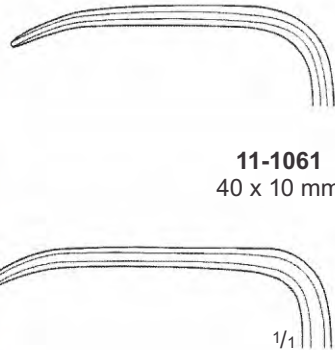

11-1061
40 x 10 mm

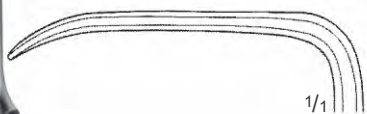

11-1062
43 x 13 mm

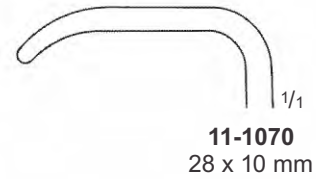

11-1070
28 x 10 mm

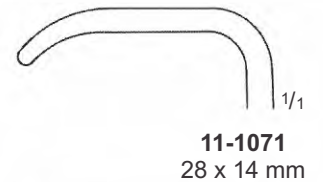

11-1071
28 x 14 mm

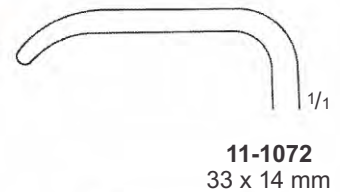

11-1072
33 x 14 mm

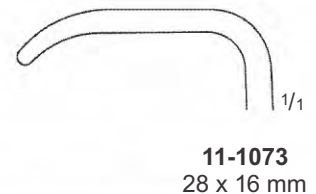

11-1073
28 x 16 mm

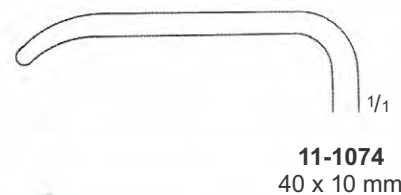

11-1074
40 x 10 mm

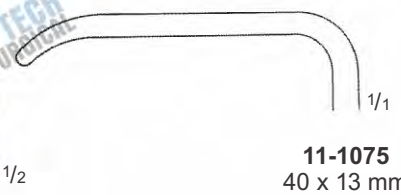

11-1075
40 x 13 mm

LANGENBECK RETRACTOR
210 mm

SOFT TECH Surgical, Manufacturer & Exporter of Quality Instruments



**KOCHER- LANGENBECK
RETRACTOR**
215 mm



11-1080
25 x 6 mm

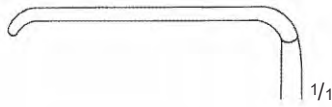

11-1081
35 x 8 mm

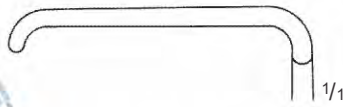

11-1082
35 x 11 mm

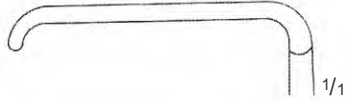

11-1083
35 x 15 mm

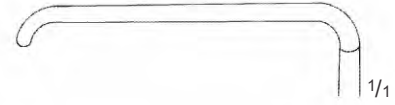

11-1084
41 x 11 mm

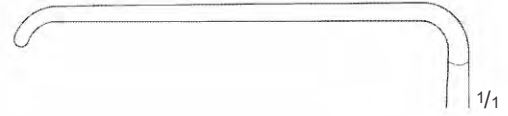

11-1085
55 x 11 mm



11-1086
70 x 14 mm



11-1087
80 x 12 mm

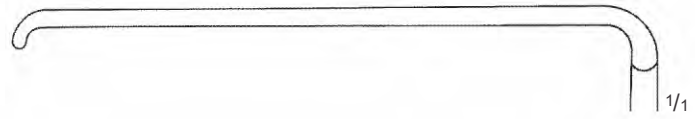

11-1088
80 x 16 mm



KOCHER RETRACTOR
11-1095
210 mm

23 x 8 mm



11-1100
55 x 20 mm
220 mm



LANGENBECK RETRACTOR

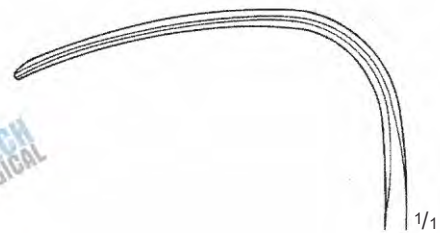

11-1101
63 x 20 mm
210 mm

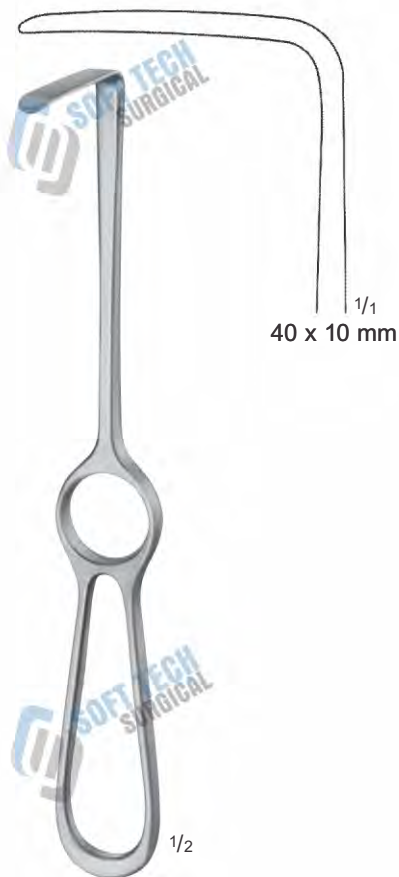

RETRACTOR
11-1105
215 mm



LANGENBECK RETRACTOR
HANDLE VERTICAL
11-1110
215 mm



SMILLIE RETRACTOR
140 mm

11-1115
32 x 19 mm

11-1120
48 x 19 mm

11-1125
57 x 19 mm

11-1130
12 x 13 mm

11-1135
52 x 13 mm



KNEE RETRACTOR
11-1140
225 mm

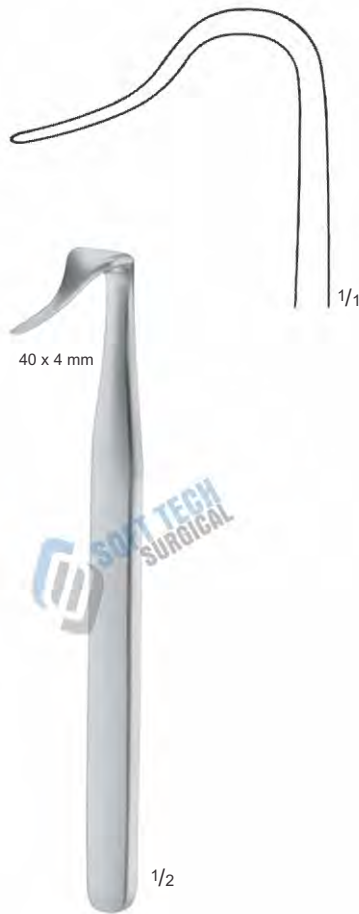

BLOUNT KNEE RETRACTOR
11-1145
175 mm



KNEE RETRACTOR
11-1150
170 mm



OBWEGESER RETRACTOR
215 mm

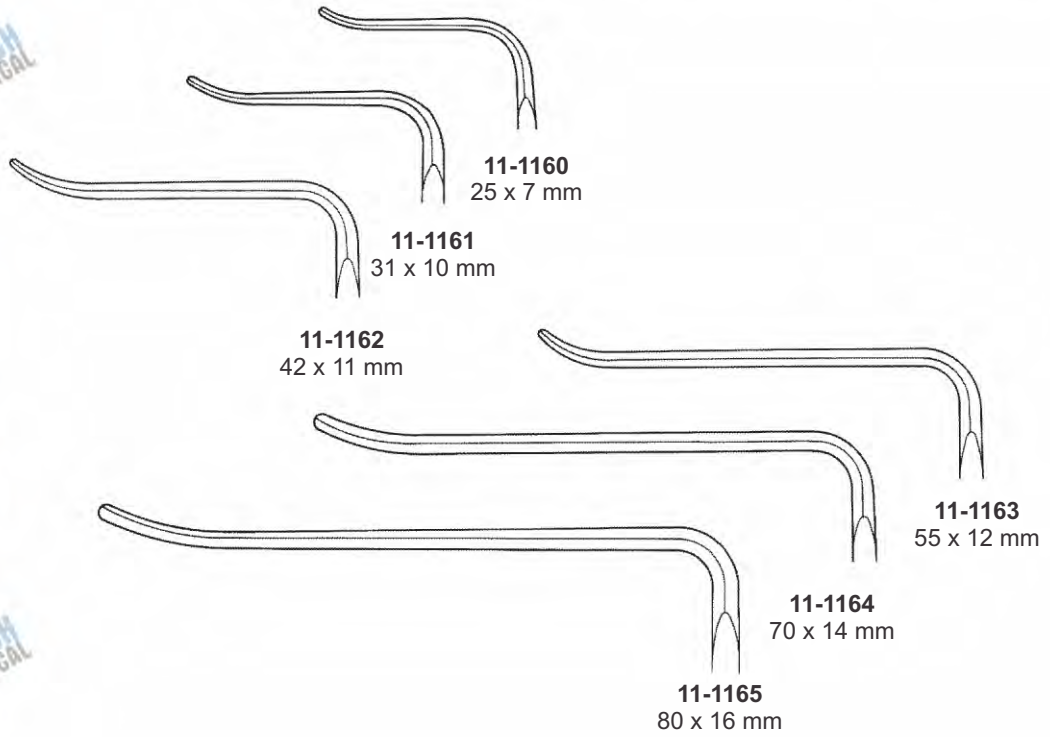

OBWEGESER RETRACTOR
215 mm

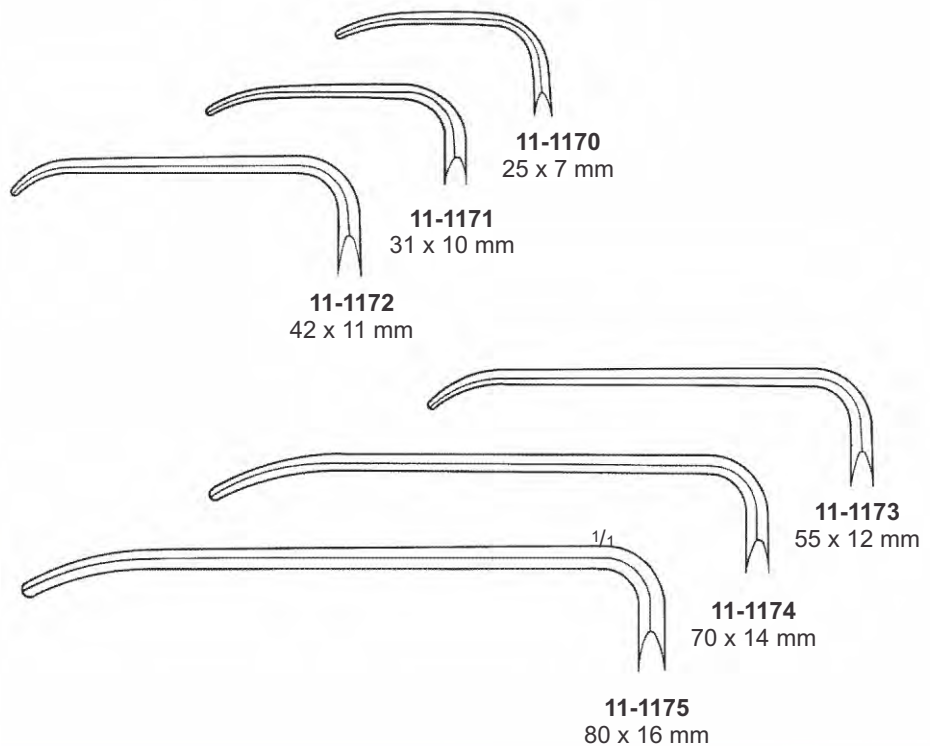

SOFT TECH Surgical, Manufacturer & Exporter of Quality Instruments

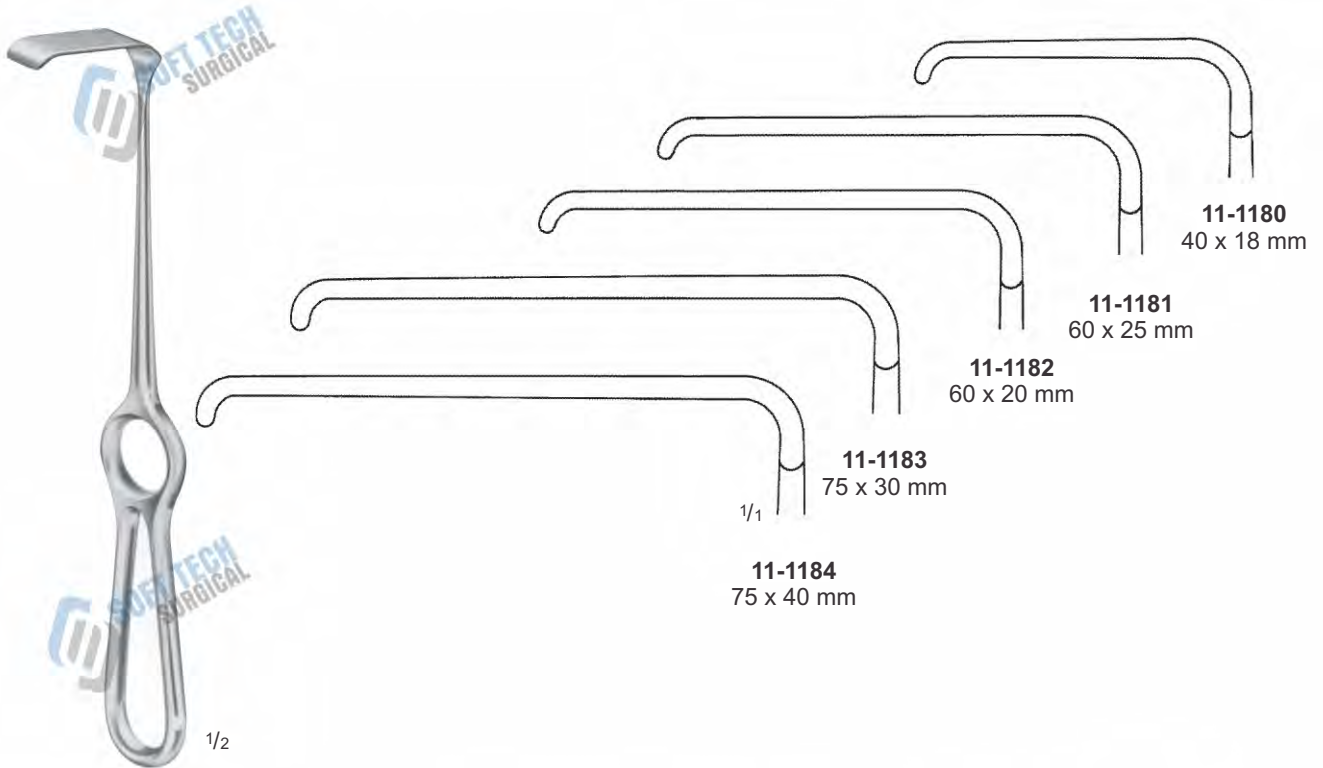

KOCHER RETRACTOR
230 mm



SAUERBRUCH RETRACTOR
225 mm

LAHEY RETRACTOR
11-1200
200 mm

SOFT TECH Surgical, Manufacturer & Exporter of Quality Instruments

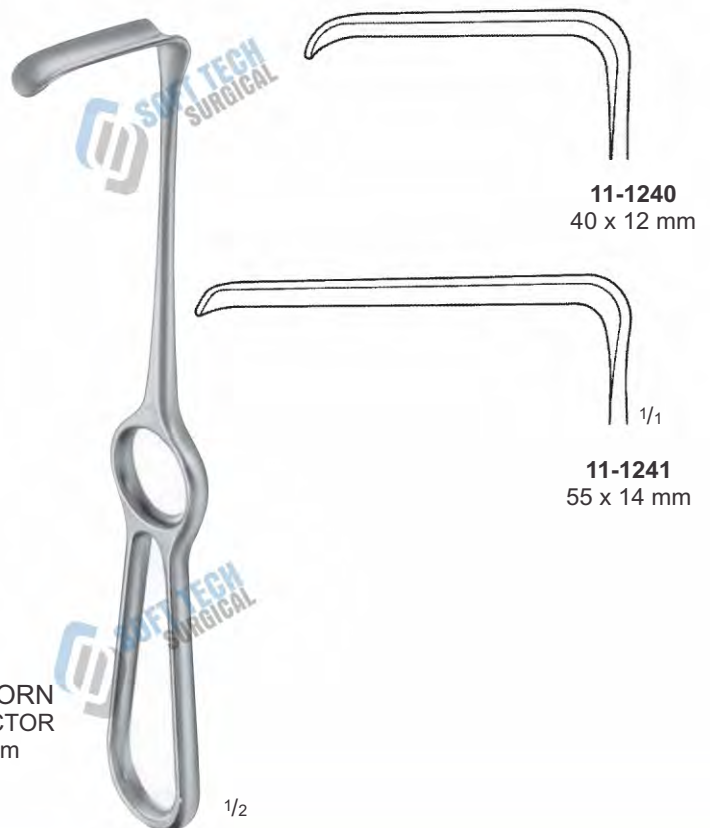
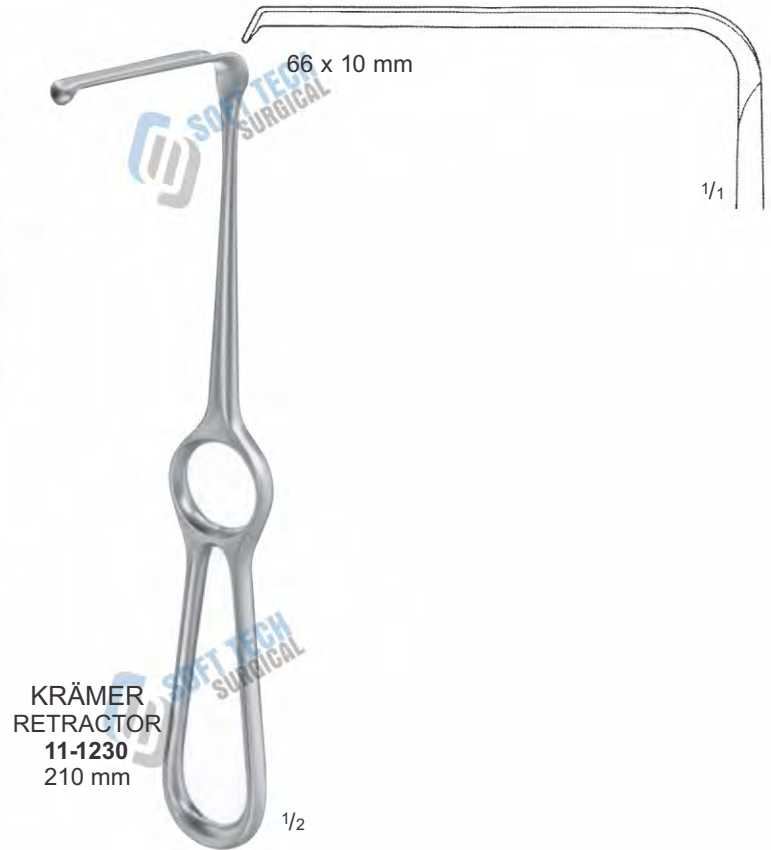



SOFT TECH Surgical, Manufacturer & Exporter of Quality Instruments



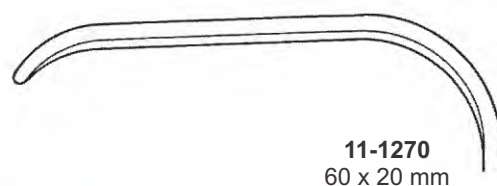
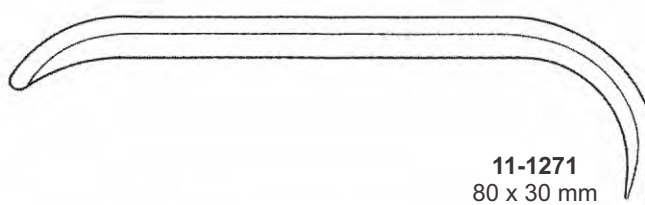
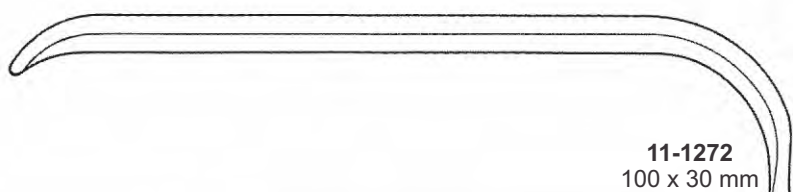
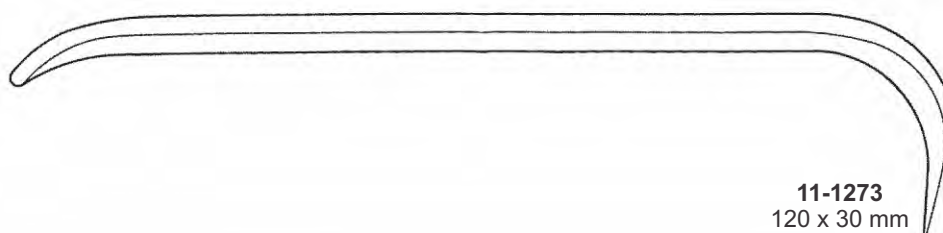
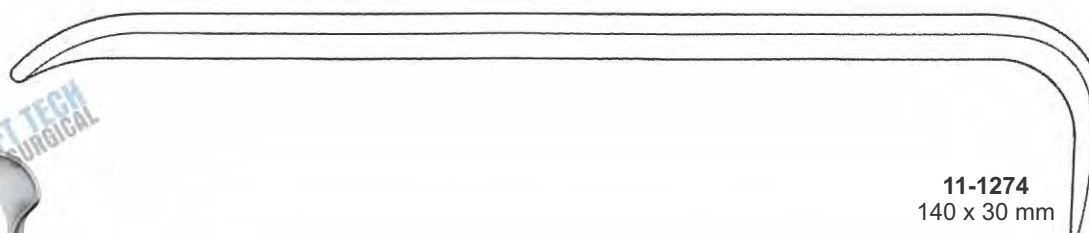
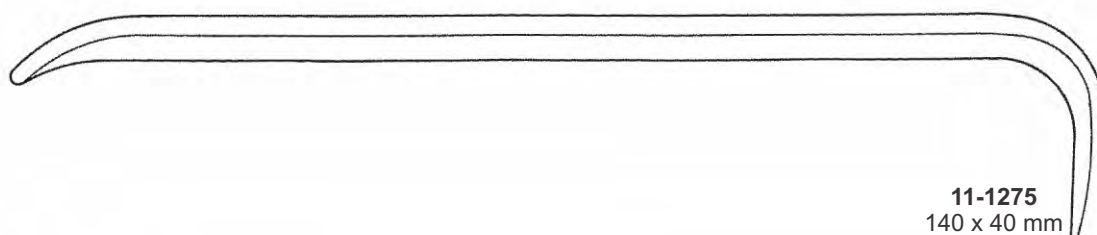
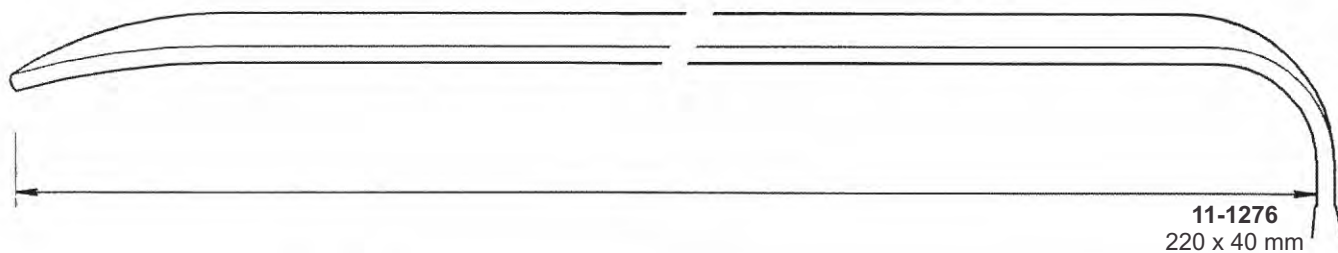

HÖSEL RETRACTOR
250 mm



11-1280
60 x 40 mm

11-1281
100 x 40 mm

11-1283
140 x 40 mm

CARBOTRAC RETRACTOR
255 mm
Titanium Black Coating



RICHARDSON- EASTMAN
RETRACTOR SET OF 2



RICHARDSON RETRACTOR
240 mm



RICHARDSON RETRACTOR
11-1295
240 mm



RICHARDSON RETRACTOR
11-1300
250 mm

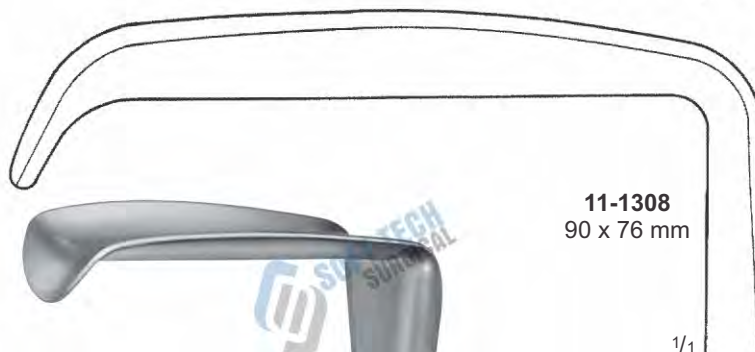
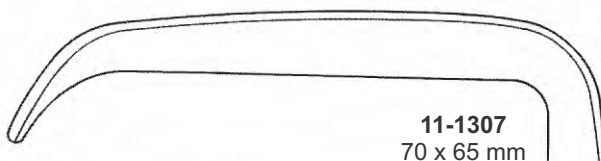
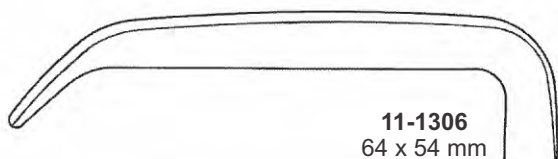
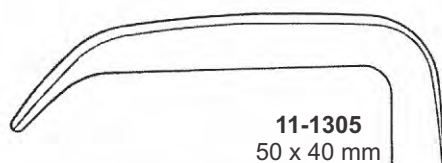

11-1310 70 x 40 mm
11-1311 70 x 50 mm
11-1312 70 x 65 mm

KELLY RETRACTOR
260 mm



MORRIS RETRACTOR
245 mm





MEYERDING RETRACTOR
SERRATED TIP



11-1320
52 x 16 mm
230 mm

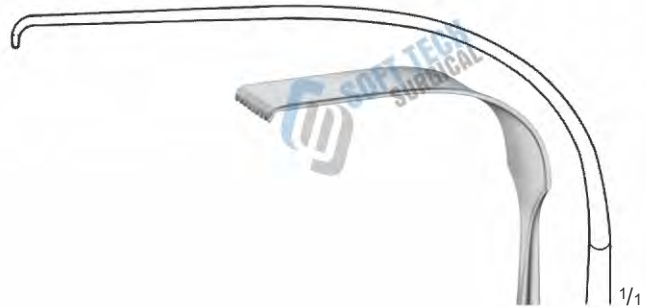

11-1321
76 x 25 mm
230 mm

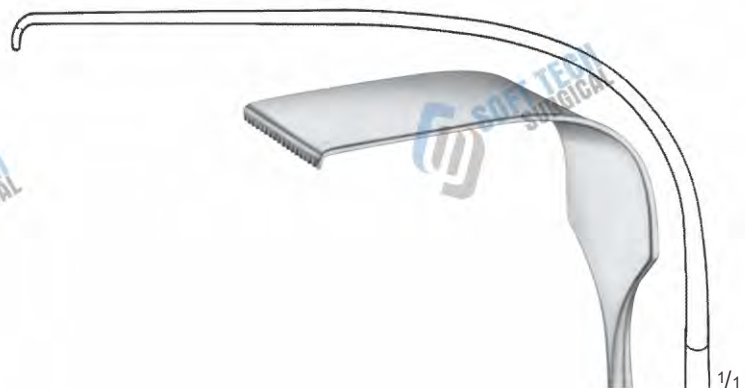

11-1322
89 x 50 mm
255 mm

SOFT TECH Surgical, Manufacturer & Exporter of Quality Instruments

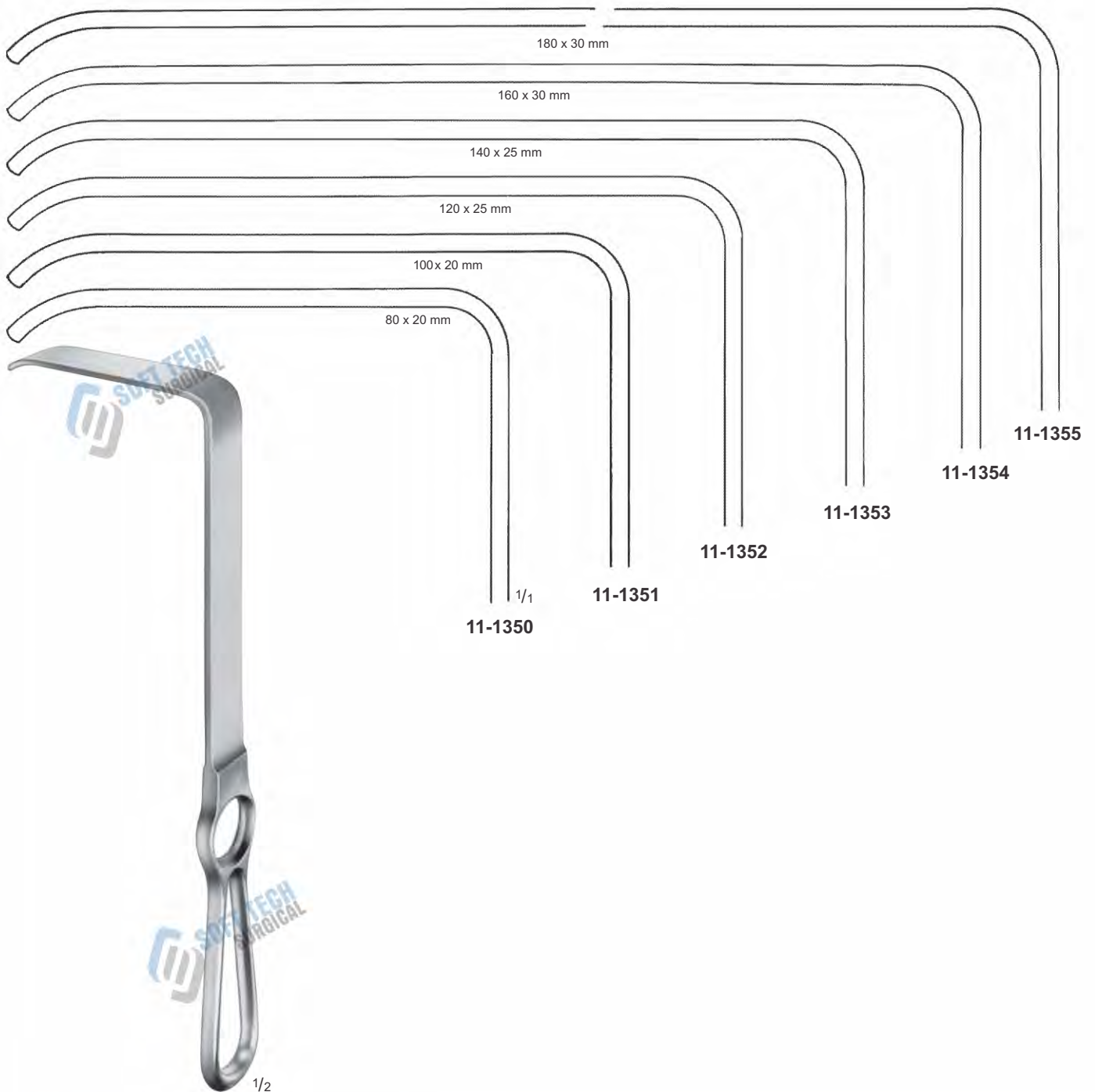

BRUNNER RETRACTOR
250 mm

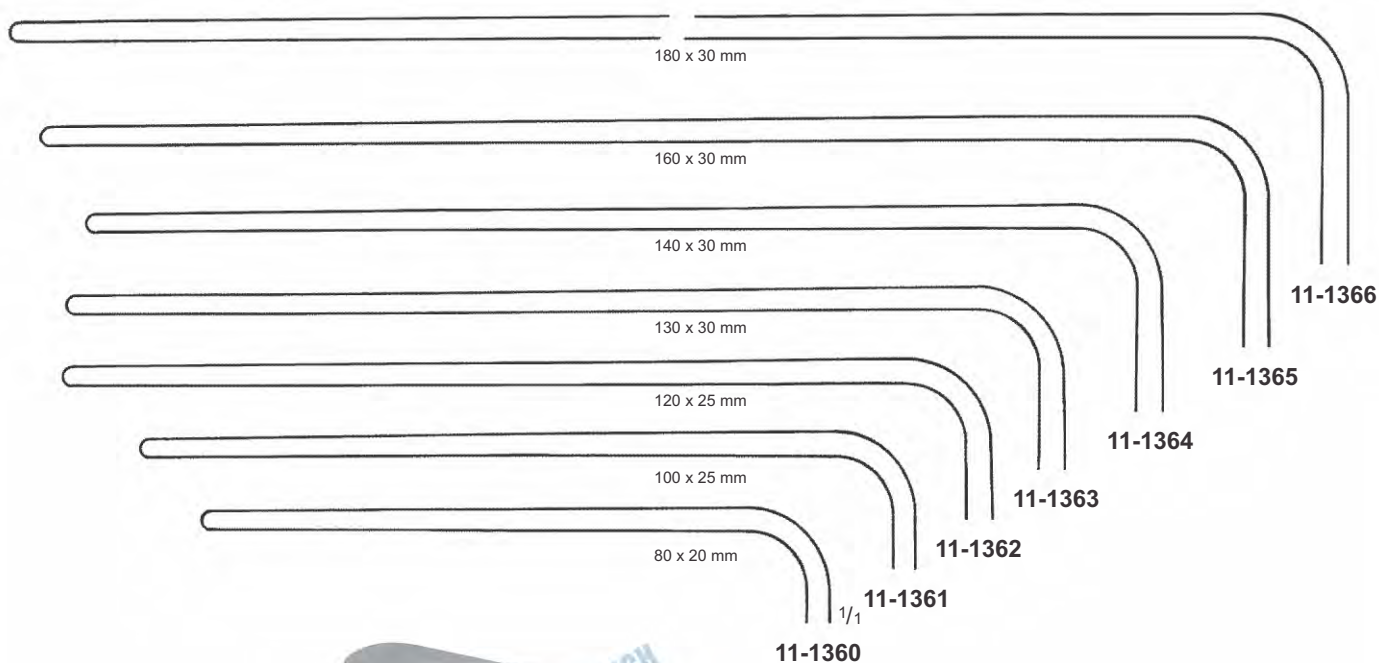

BRUNNER RETRACTOR
275 mm

SOFT TECH Surgical, Manufacturer & Exporter of Quality Instruments

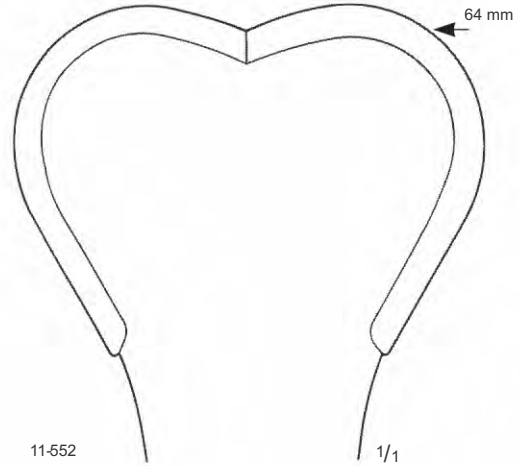
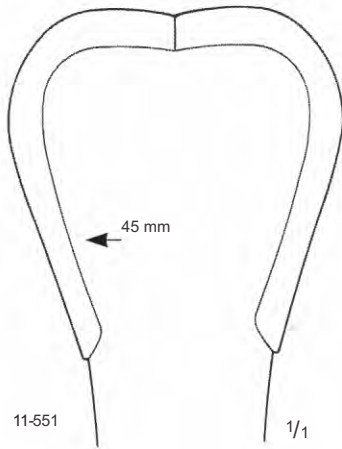

**HARRINGTON
RETRACTOR FLEXIBLE**
11-1370 123 x 45 mm
11-1371 123 x 64 mm
 295 mm

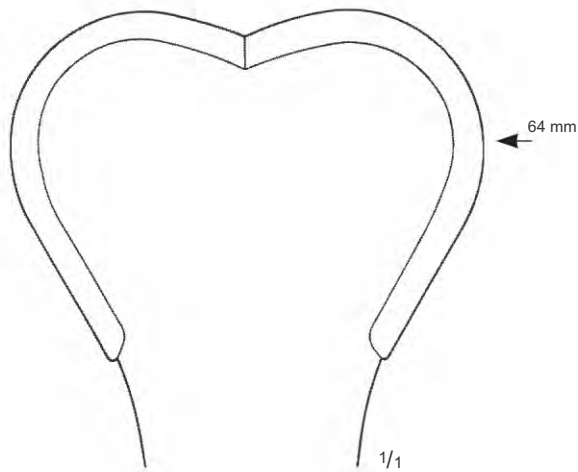

HARRINGTON PEMBERTON
RETRACTOR FLEXIBLE
11-1375
175 x 64 mm

SOFT TECH Surgical, Manufacturer & Exporter of Quality Instruments

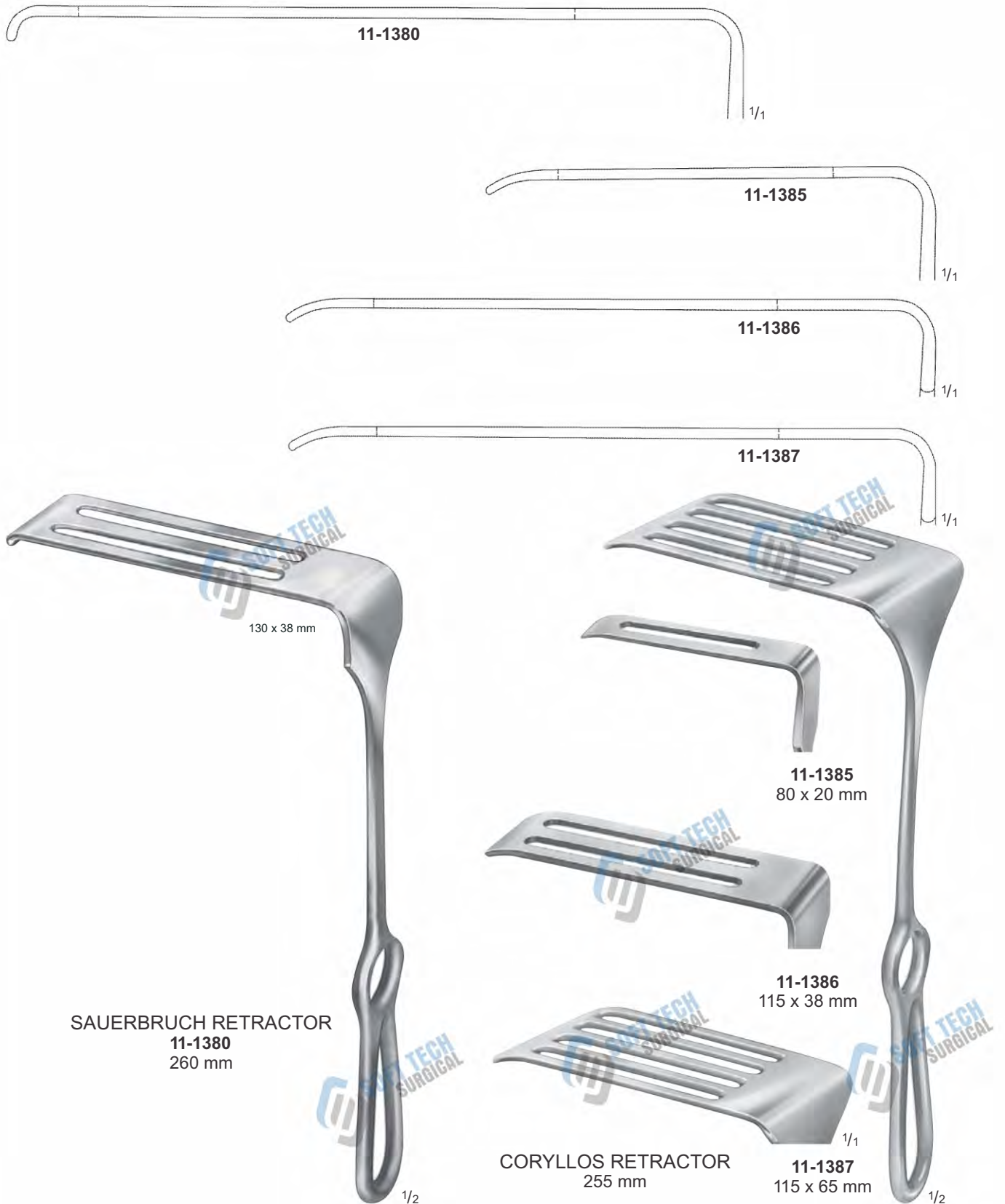



DAVIDSON SCAPULA
RETRACTOR
11-1390
195 mm

SOFT TECH Surgical, Manufacturer & Exporter of Quality Instruments

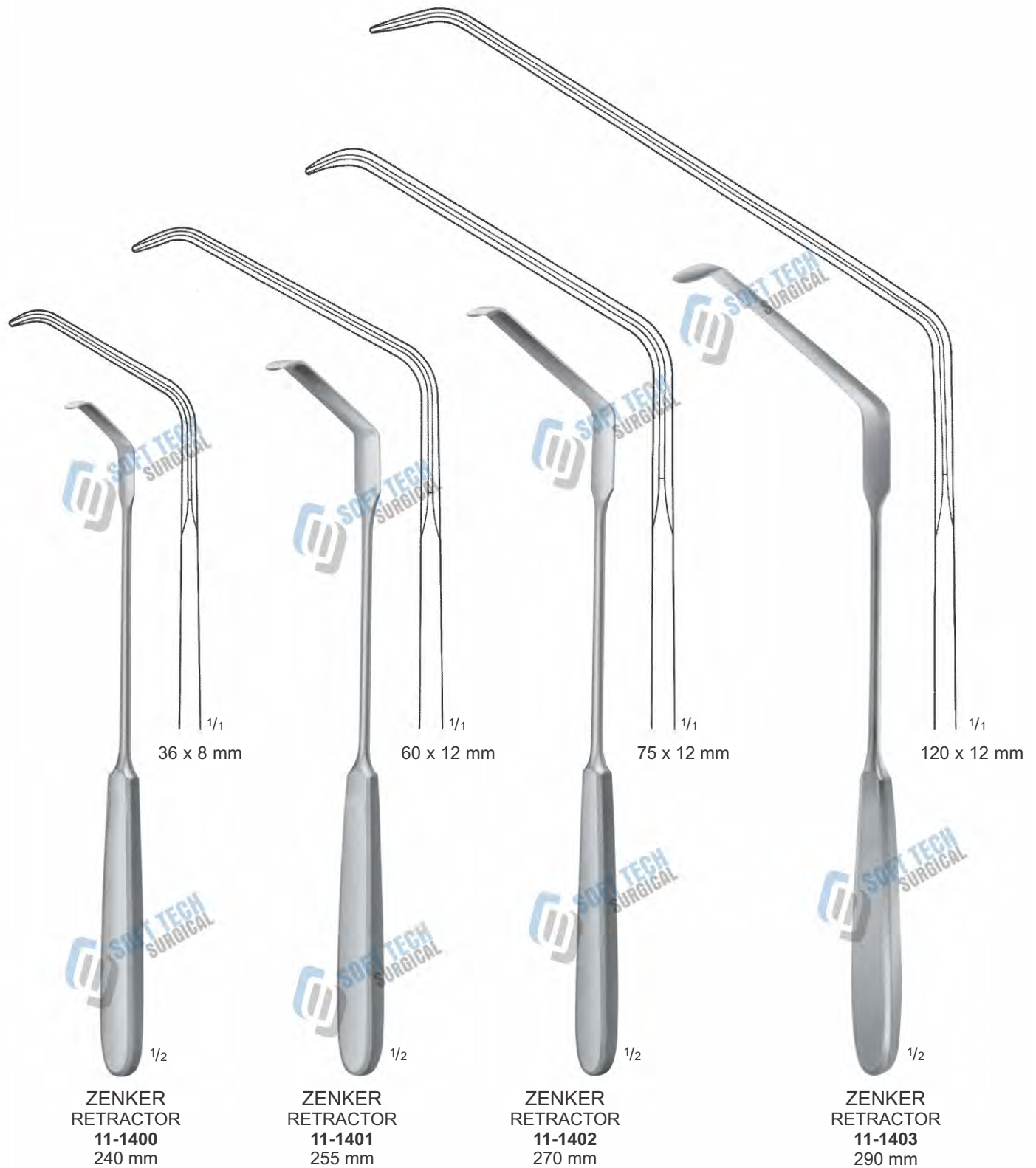

SOFT TECH Surgical, Manufacturer & Exporter of Quality Instruments

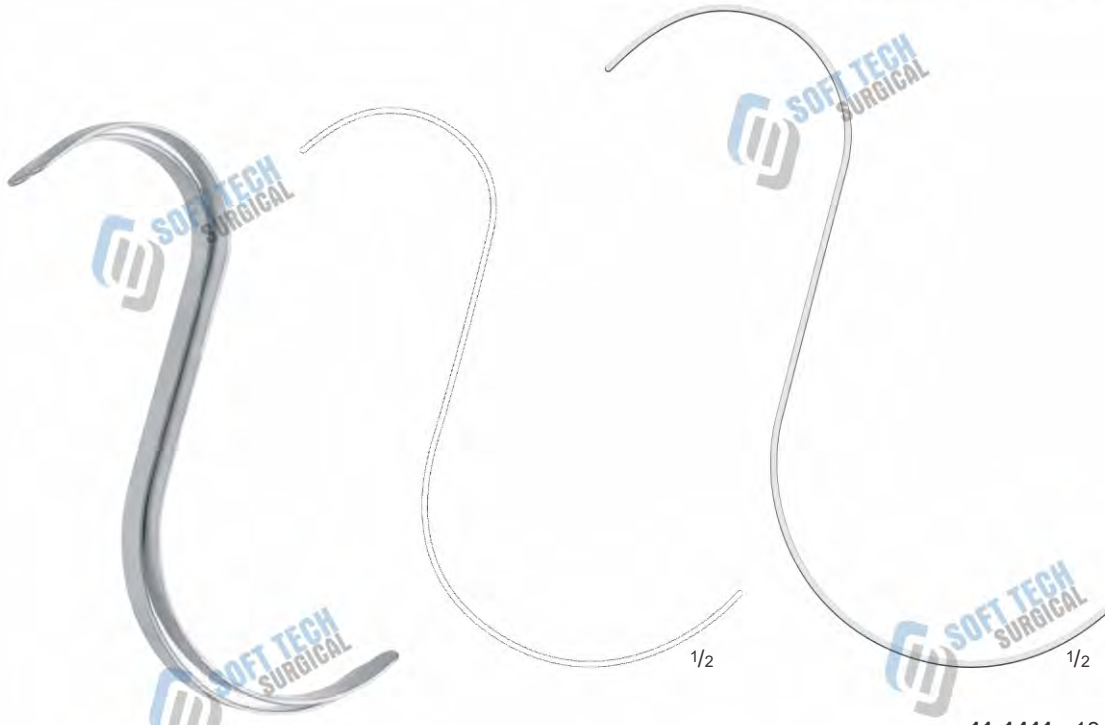

HASSON S-RETRACTOR
DOUBLE ENDED

11-1410 , 10 mm
160 mm

11-1411 , 13 mm
180 mm



DEEVER RETRACTOR
11-1415, 180 mm
Fig. 000

DEEVER RETRACTOR
11-1420 , 215 mm,
Fig. 00

DEEVER RETRACTOR
11-1425, 235 mm,
Fig. 0



DEAVER RETRACTOR
11-1430
Fig. 1
300 mm



DEAVER RETRACTOR
11-1435
Fig. 2
315 mm



DEAVER RETRACTOR
11-1440
Fig. 2 1/2
365 mm



DEAVER RETRACTOR
11-1445
Fig. 3
300 mm



DEAVER RETRACTOR
11-1450
Fig. 4
310 mm

DEAVER RETRACTOR
11-1455
Fig. 5
320 mm



DEAVER RETRACTOR
11-1460
Fig. 1
310 mm



DEAVER RETRACTOR
11-1465
Fig. 3
310 mm



DEAVER RETRACTOR
11-1470
Fig. 4
305 mm



DEAVER RETRACTOR
11-1475
Fig. 5
310 mm



LERICHE INTESTINAL SPATULA
11-1480
255 mm

LERICHE INTESTINAL SPATULA
11-185
275 mm



KÜMMEL INTESTINAL SPATULA
MALLEABLE
11-1490
285 mm



KÖRTE INTESTINAL SPATULA
11-1495
300 mm



MIKULICZ ABDOMINAL
RETRACTOR
11-1500
255 mm

MIKULICZ ABDOMINAL
RETRACTOR
11-1505
240 mm

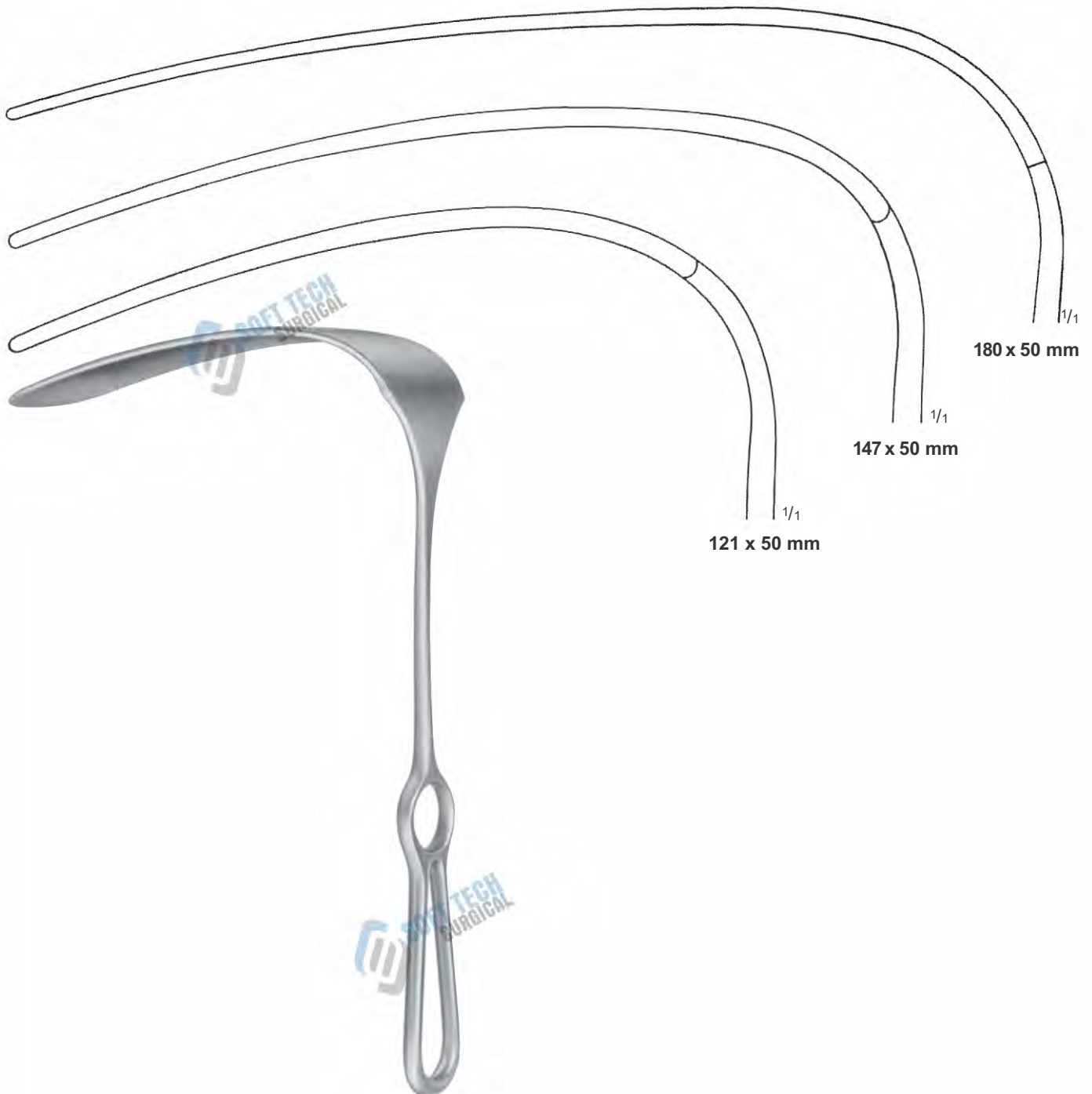

MIKULICZ ABDOMINAL RETRACTOR

- 11-1510** 250 mm
- 11-1511** 250 mm
- 11-1512** 260 mm

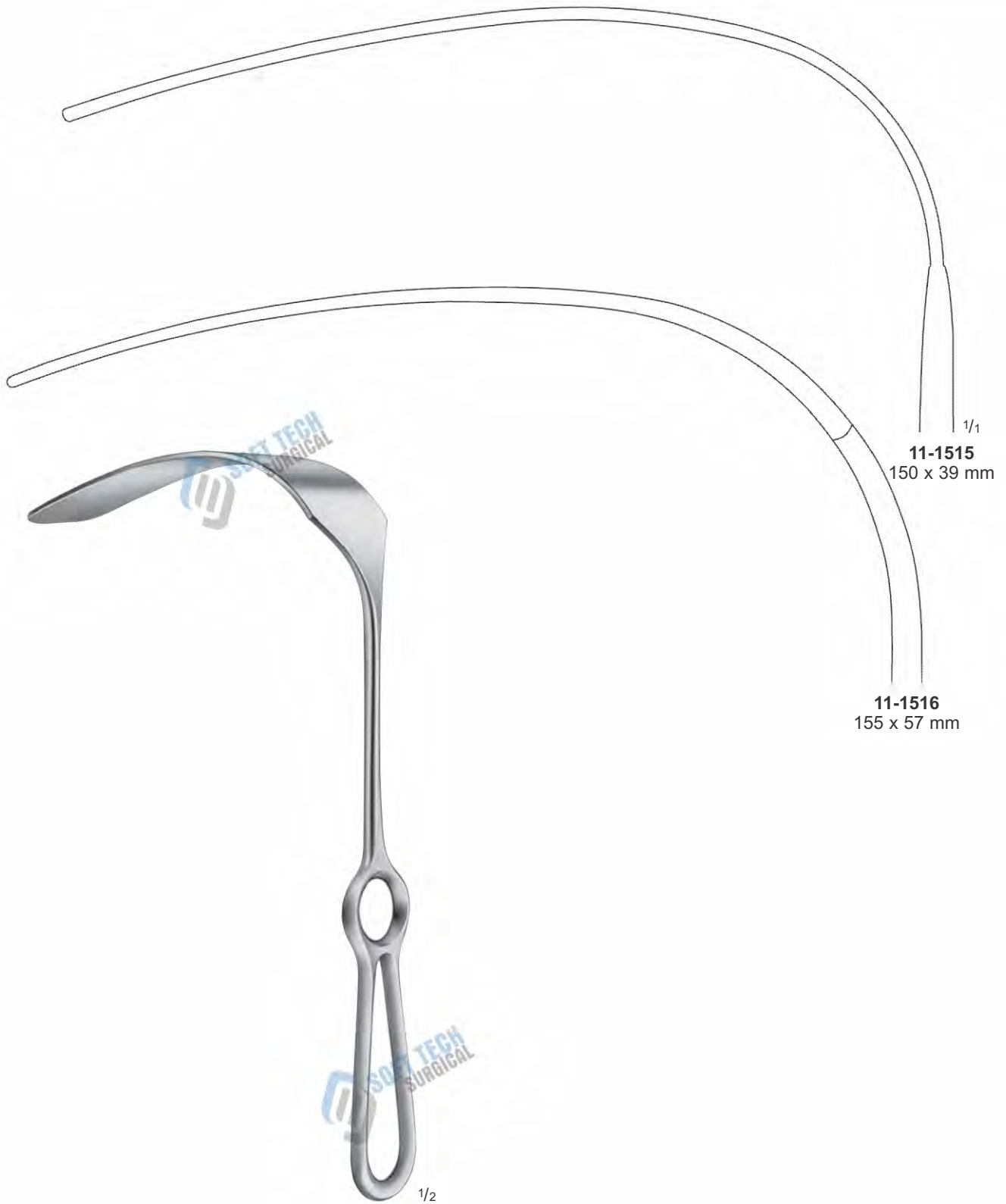

KELLY ABDOMINAL RETRACTOR
260 mm

SOFT TECH Surgical, Manufacturer & Exporter of Quality Instruments

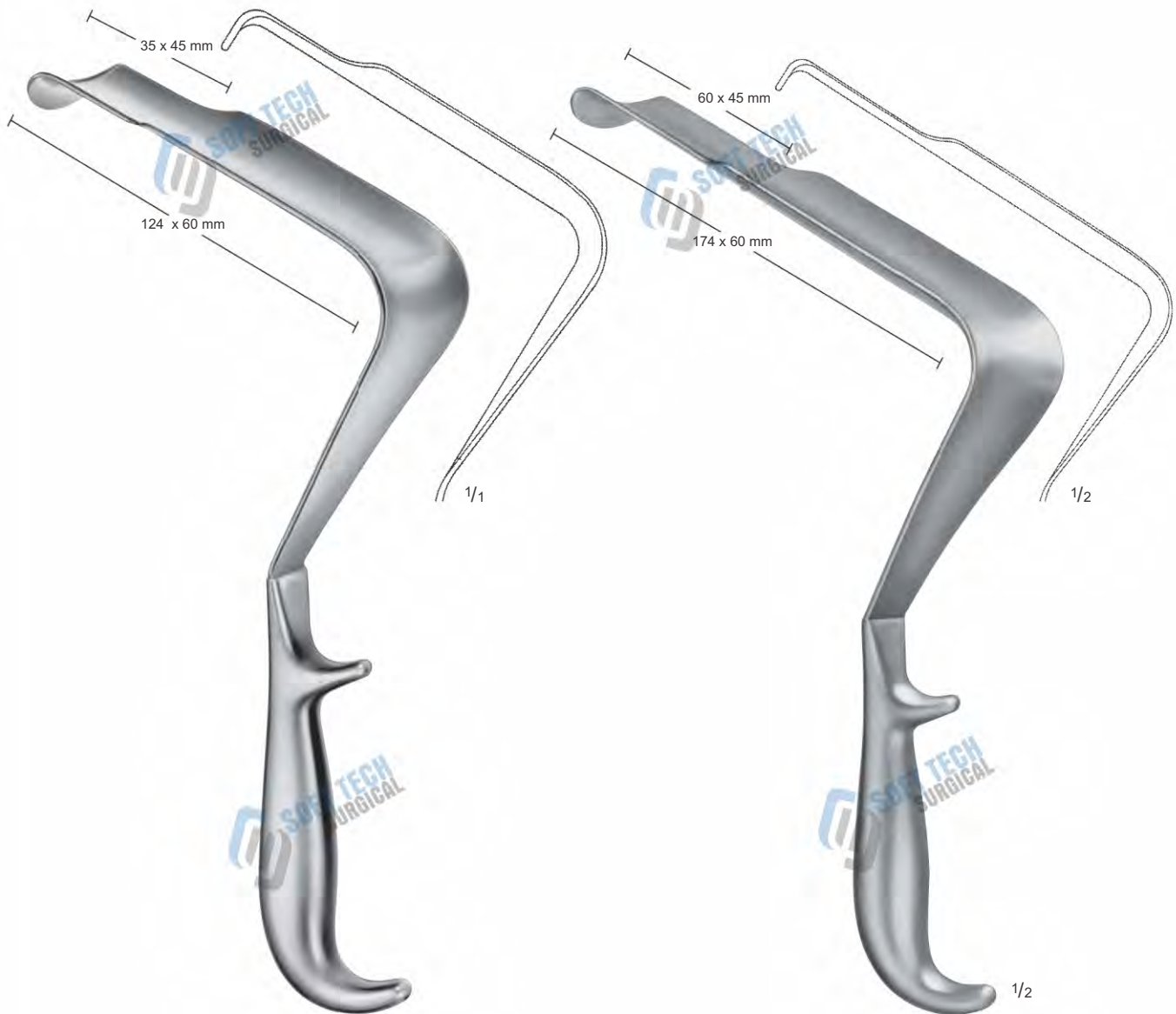

ST. MARKS PELVIS RETRACTOR
11-1520
290 mm

ST. MARKS PELVIS RETRACTOR
11-1525
330 mm

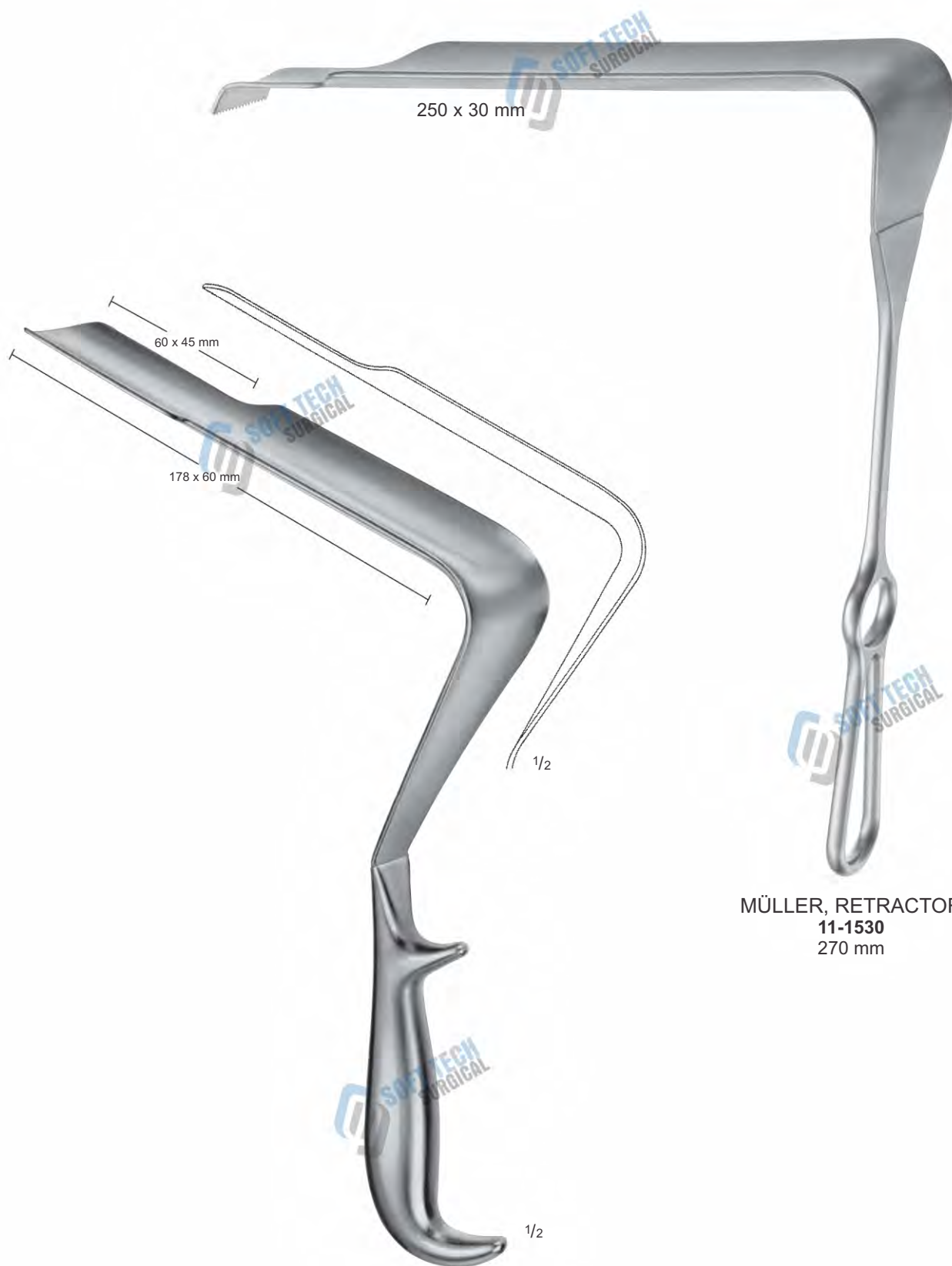

MÜLLER, RETRACTOR
11-1530
270 mm

ST. MARKS PELVIS
RETRACTOR
11-1535
330 mm



**TUDOR- EDWARDS
RETRACTOR**
11-1540
205 mm



**TUFFIER ABDOMINAL
RETRACTOR**
11-1545
215 mm

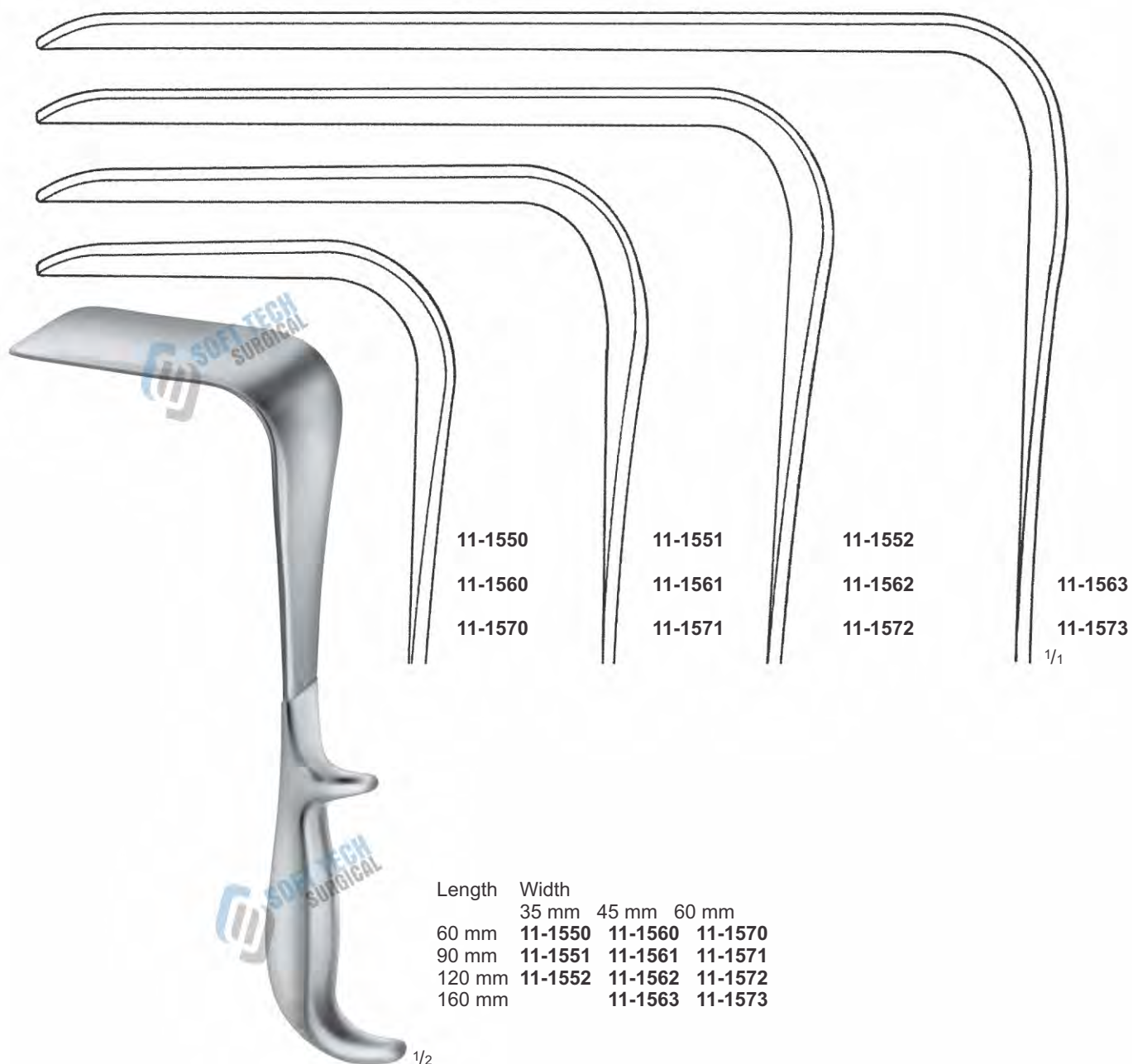

DOYEN VAGINAL SPECULA
240 mm

SOFT TECH Surgical, Manufacturer & Exporter of Quality Instruments

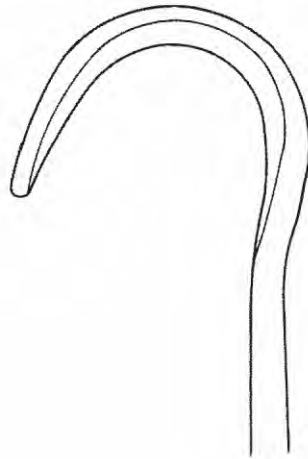

11-1580
Fig. 1
32 x 40 mm

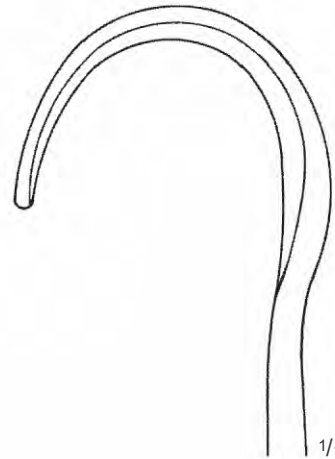

11-1581
Fig. 2
34 x 50 mm

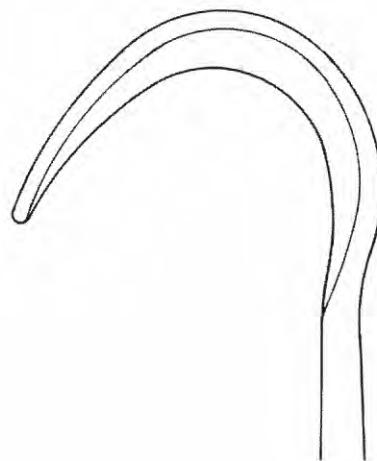

11-1582
Fig. 3
41 x 60 mm

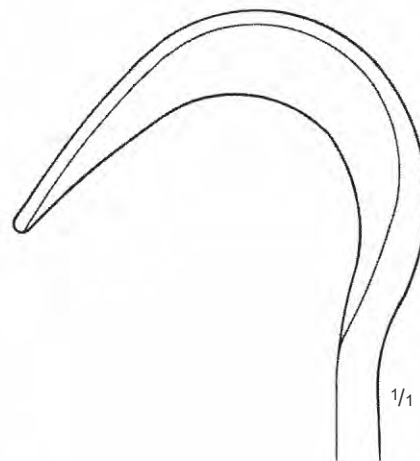

11-1583
Fig. 4
46 x 75 mm



**FRITSCH ABDOMINAL
RETRACTOR**
235 mm

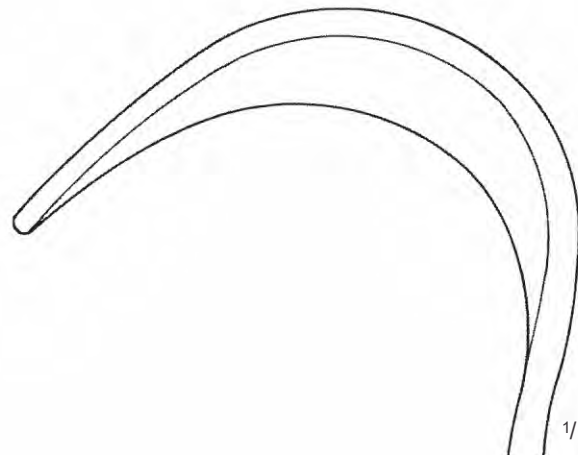

11-1584
Fig. 5
64 x 85 mm



DOYEN
ABDOMINAL RETRACTOR
11-1590
50 mm



DOYEN
ABDOMINAL RETRACTOR
11-1595
260 mm

SOFT TECH Surgical, Manufacturer & Exporter of Quality Instruments



**DOYEN ABDOMINAL
RETRACTOR**
11-1600 48 x 90 mm
11-1601 48 x 105 mm
11-1602 48 x 120 mm
11-1603 48 x 135 mm
 280 mm



**CHAIN WITH WEIGHT FOR
RETRACTOR**
11-1610
 weight (645 g)
 790 mm

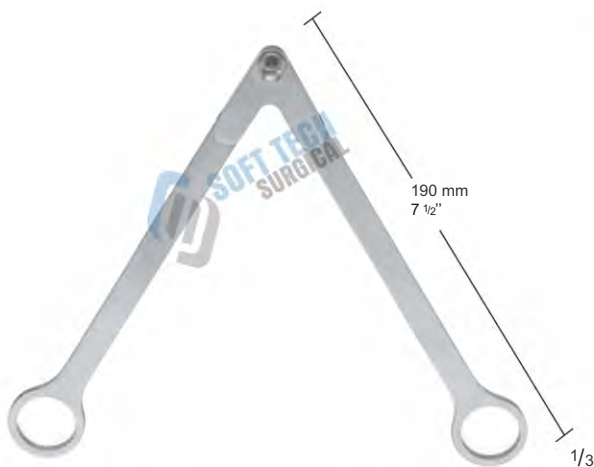

ROCHARD FIXATION DEVIC
11-1615
 190 mm



**ROCHARD ABDOMINAL
RETRACTOR**
11-1620 48 x 90 mm
11-1621 48 x 105 mm
11-1622 48 x 120 mm
11-1623 48 x 135 mm
11-1624 48 x 155 mm
 310 mm



REVERDIN
INTESTINAL
SPATULA
11-1630
285 mm



HABERER INTESTINAL
SPATULA MALLEABLE
TAPERED
11-1635
305 mm



1/3

**RIBBON ABDOMINAL
INTESTINAL SPATULA
MALLEABLE**

11-1640 25 mm
11-1641 30 mm
11-1642 40 mm
11-1643 50 mm
330 mm



25 mm

**TUFFIER INTESTINAL
SPATULA MALLEABLE
TAPERED**

11-1650
200 mm



12-25 mm

SPATULA MALLEABLE

11-1655 12 mm 200 mm
11-1656 17 mm 200 mm
11-1657 25 mm 250 mm

SOFT TECH Surgical, Manufacturer & Exporter of Quality Instruments



KADER INTESTINAL SPATULA

- 11-1660** 30 mm
- 11-1661** 40 mm
- 270 mm



**INTESTINAL SPATULA
MALLEABLE**

- 11-1670** 30 mm
- 11-1671** 40 mm
- 11-1672** 50 mm
- 11-1673** 60 mm
- 11-1674** 70 mm
- 410 mm

SOFT TECH Surgical, Manufacturer & Exporter of Quality Instruments



BARRÉ PROSTATE
RETRAKTOR
11-1680
360 mm



BARRÉ URETHRAL
RETRACTOR
11-1685
390 mm



**SOFT TECH
SURGICAL**

General Surgery Instruments Catalogue

SOFT TECH Surgical

Muslim Town, Airport Road
Kotli Behram, Sialkot 51310
Pakistan.

Email : info@softtechsurgical.com
Website : www.softtechsurgical.com

Phone : +92 52 3573488
+92 52 3242929
+92 52 4264934
Fax : +92 52 3242929

 +92 336 4770459